

## SPECIFICATION

Part No. : **CAB.A02**

Product Name : Taoglas Cable Assembly  
SMA(F) Bulkhead Straight to  
IPEX MHFIII(W.FL comp)  
with 95mm  $\varnothing$ 0.81mm cable

Photo :



## 1.0 Cable Insertion Loss

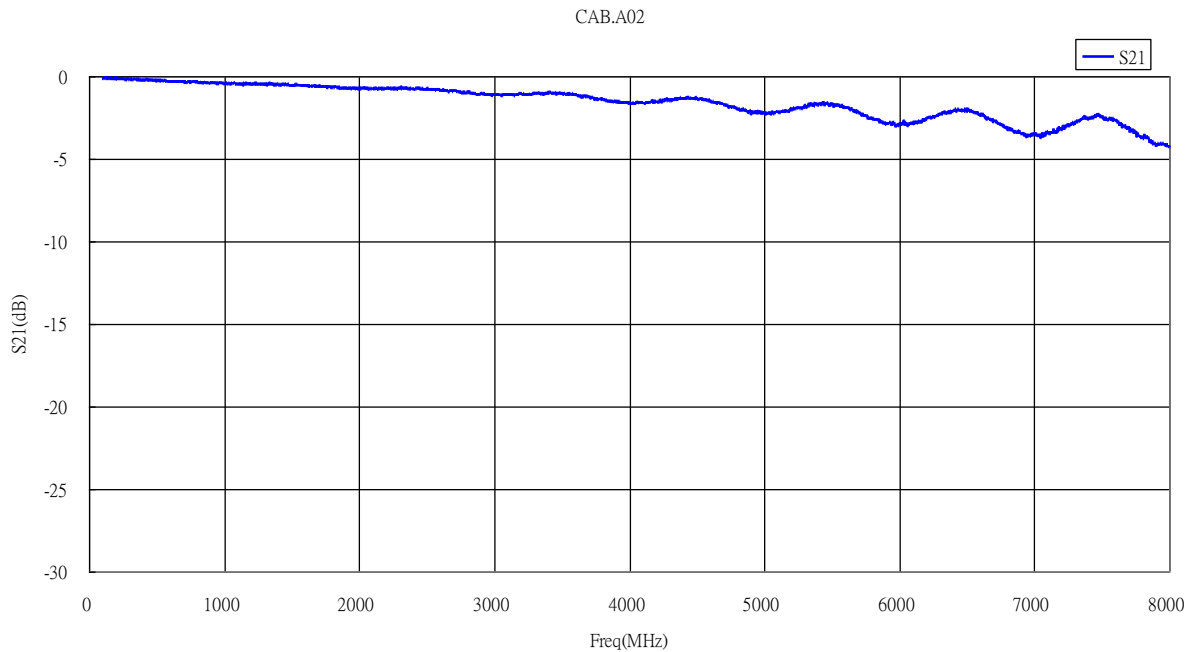

## 2.0 Ø0.81mm Cable Specification

### 2.1 Drawing – Cross Section

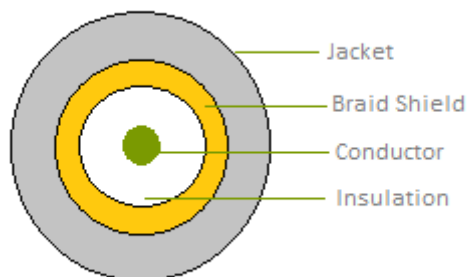

## 2.2 Structure and Dimensions

### Structure and Dimensions

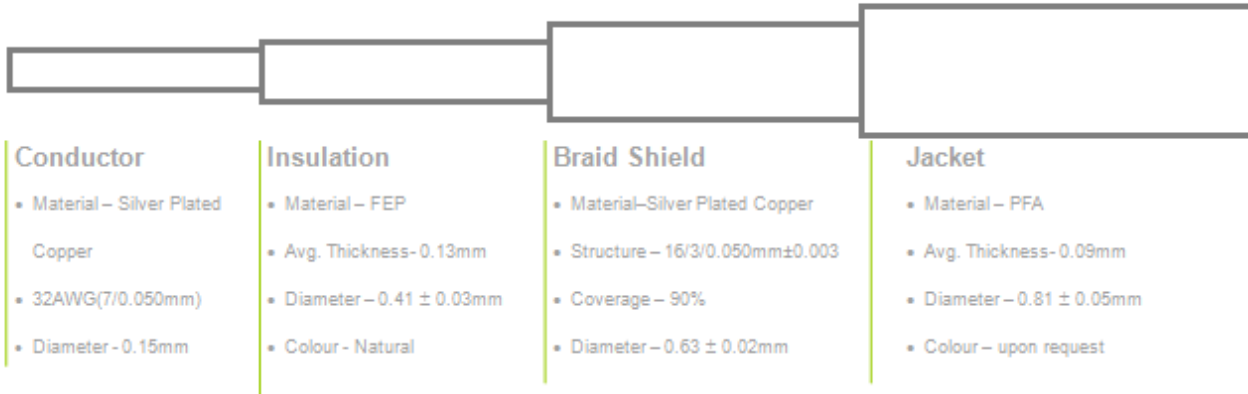

## 2.3 Electrical & Physical Specification

1	Insulation Resistance:	1000 MEGA OHM-KM Min.
2	Conductor Resistance:	1400 OHM/KM/20°C Max.
3	Dielectric Strength:	AC 1.0 KV/minute
4	Spark test:	2.5 KV
5	Nom. Impedance	50 ± 3 Ohms
6	Nom. Capacitance	97 ± 3 pF/m
7	Attenuation (dB/1M)	1.0GHz    3.60 2.0GHz    5.10 3.0GHz    6.20 4.0GHz    7.50 5.0GHz    8.50 6.0GHz    9.40

### 3.0 Technical Drawing

#### 3.1 CAB.A02

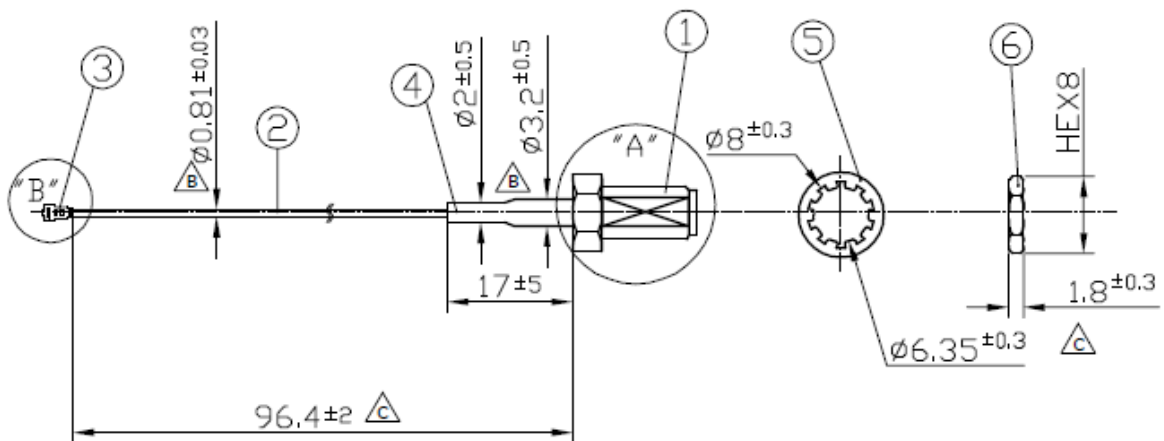
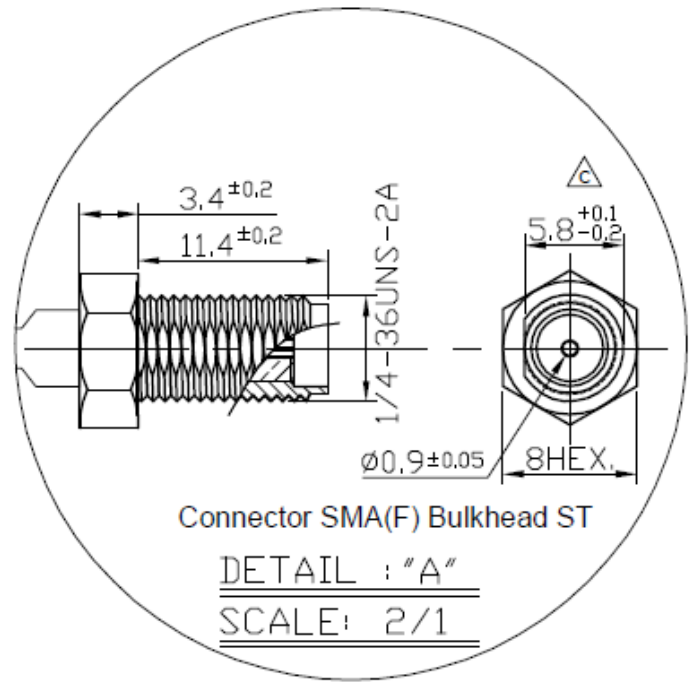
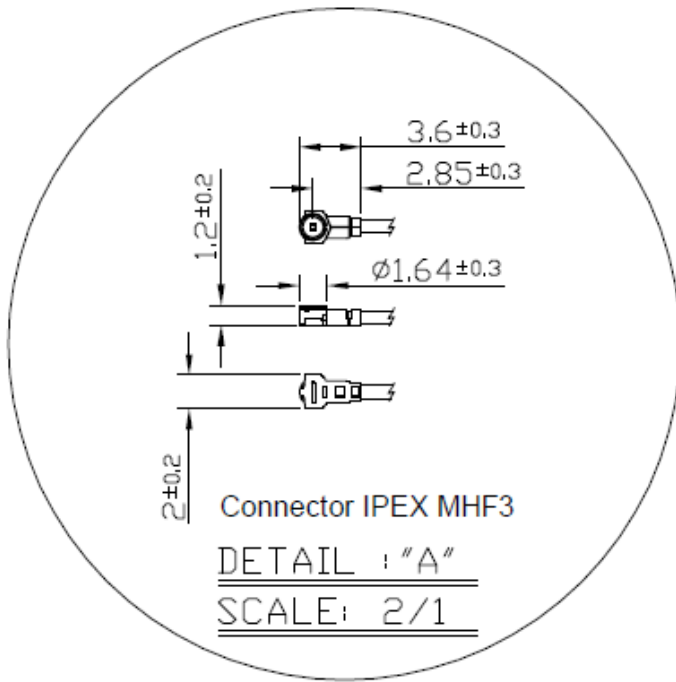

## 3.2 Connectors

### 3.2.1 SMA(F) Bulkhead Jack

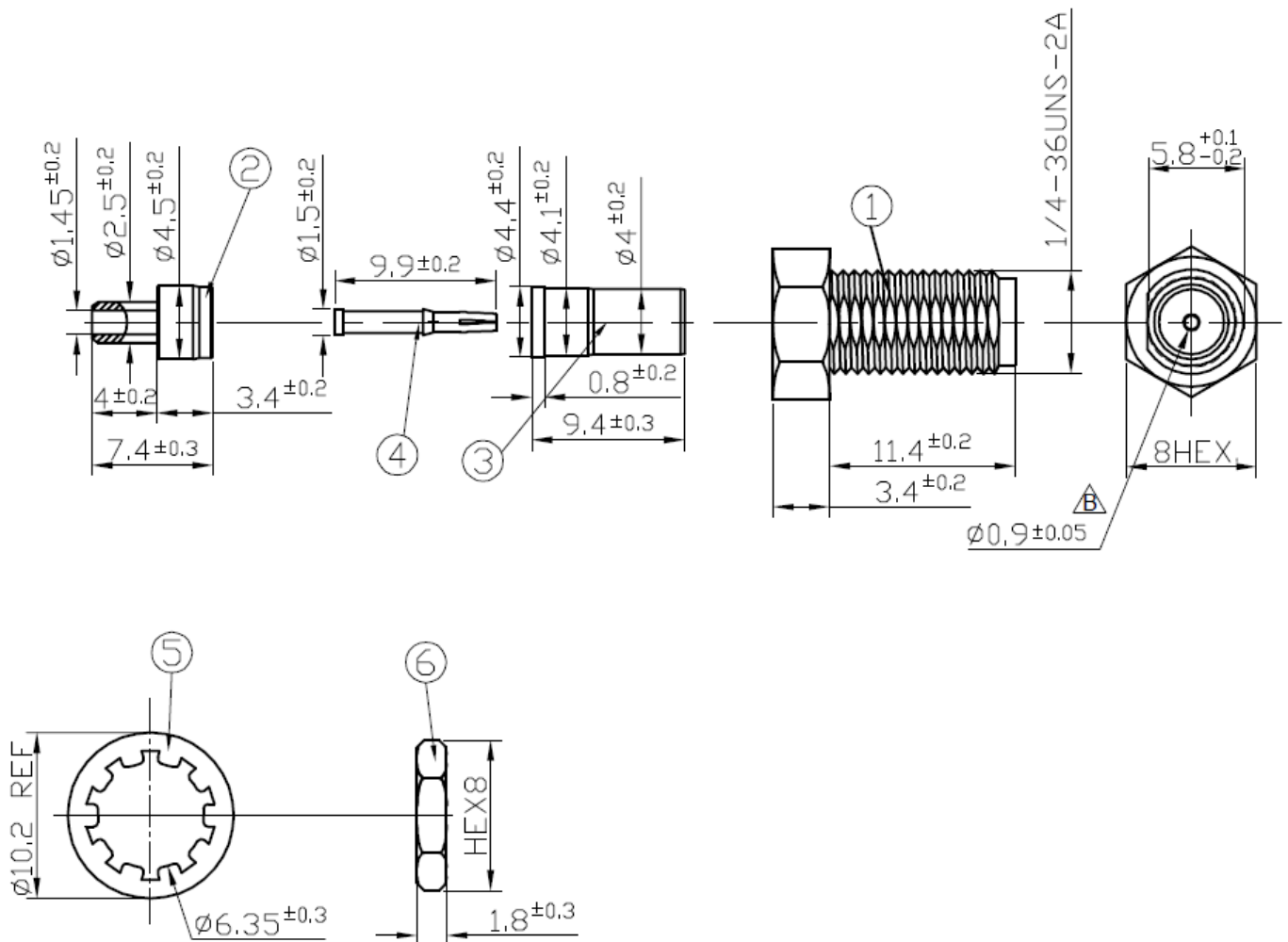

	Name	Material	Finish	QTY
1	Body	Brass	Gold	1
2	Body	Brass	Gold	1
3	Insulator	PTFE	White	1
4	Female Contact	Copper	Gold	1
5	Washer	Brass	Gold	1
6	Nut	Brass	Gold	1

### 3.2.2 IPEX MHFIII(W.FL comp)

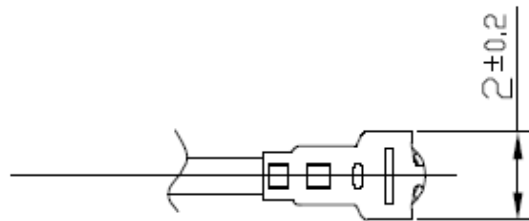

Bottom

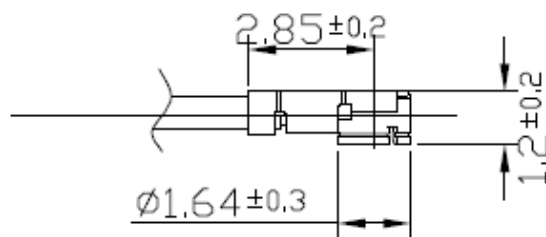

Side

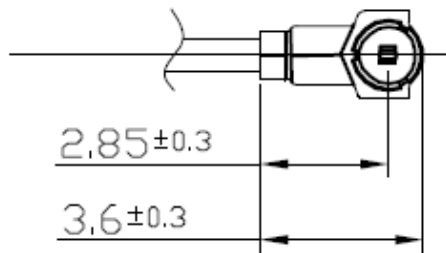

Top

Mated View

