



I-Bar

GSA.8821.B.301111

Specification

Part No.	GSA.8821.B.301111
Product Name	I-Bar Penta-Band Cellular Antenna Works with GSM / CDMA / PCS / DCS / UMTS / WCDMA
Feature	Low profile for easy installation Fully customized cable and connector RoHS Compliant

1. Introduction

GSA.8821 I-Bar Penta-band Cellular Antenna is flexible and robust. The slim-line designed for covert and convenient installation in automotive vehicles.

Its omni-directional gain across all bands ensures constant reception and transmission. This dipole antenna is designed to be mounted on glass or plastic (not on metal). Cables and connectors are fully customizable. It comes with strong 3M double-sided adhesive for a permanent and secure fix to your vehicle interior.

2. Specification

ELECTRICAL						
System		AMPS	GSM	DCS	PCS	UMTS
Band (MHz)		824-896	880-960	1710-1880	1850-1990	1710-2170
Free space Return Loss (dB)						
Cable Length in meters	3.0m	-7.8	-8.5	-9.2	-13.6	-16.0
	2.0m	-6.3	-6.6	-6.5	-9.5	-11.2
	1.0m	-4.7	-5.4	-4.7	-10.1	-10.1
	0.5m	-3.8	-3.9	-3.6	-10.1	-10.0
Free space Peak Gain (dBi)						
Cable Length in meters	3.0m	-5.1	-1.6	-2.7	-2.7	-2.7
	2.0m	-1.2	1.3	2.2	2.2	2.2
	1.0m	1.8	1.8	1.9	2.7	2.7
	0.5m	-0.5	2.6	1.8	2.8	2.8
Free space Efficiency (%)						
Cable Length in meters	3.0m	7%	20%	12%	15%	12%
	2.0m	24%	45%	28%	37%	32%
	1.0m	42%	46%	41%	52%	44%
	0.5m	35%	59%	40%	53%	45%
Polarization		Linear				
Impedance		50 ohms				
Input Power		10W max				

2. Specification

MECHANICAL	
Dimensions	106.7 x 14.7 x 5.3mm
Cable	RG 174 Standard, Fully customizable
Connector	SMA (M) Standard, Fully customizable
Casing	UV Resistant TPE
Weight	40g
ENVIRONMENTAL RATINGS	
Waterproof	IP65
Temperature Range	-40°C to +105°C
Thermal Shock	100 cycles -40°C to +85°C
Humidity	Non-condensing 65°C 95% RH
Shock (Drop Test)	1m drop on concrete 6 axes
Cable Pull	8kgf

* Electrical properties are measurement of GSA.8821 with 3m RG174 SMA(M) in free space.

3. S11 Property of GSA.8821 with RG.174 Cable

3.1 Free Space Return Loss

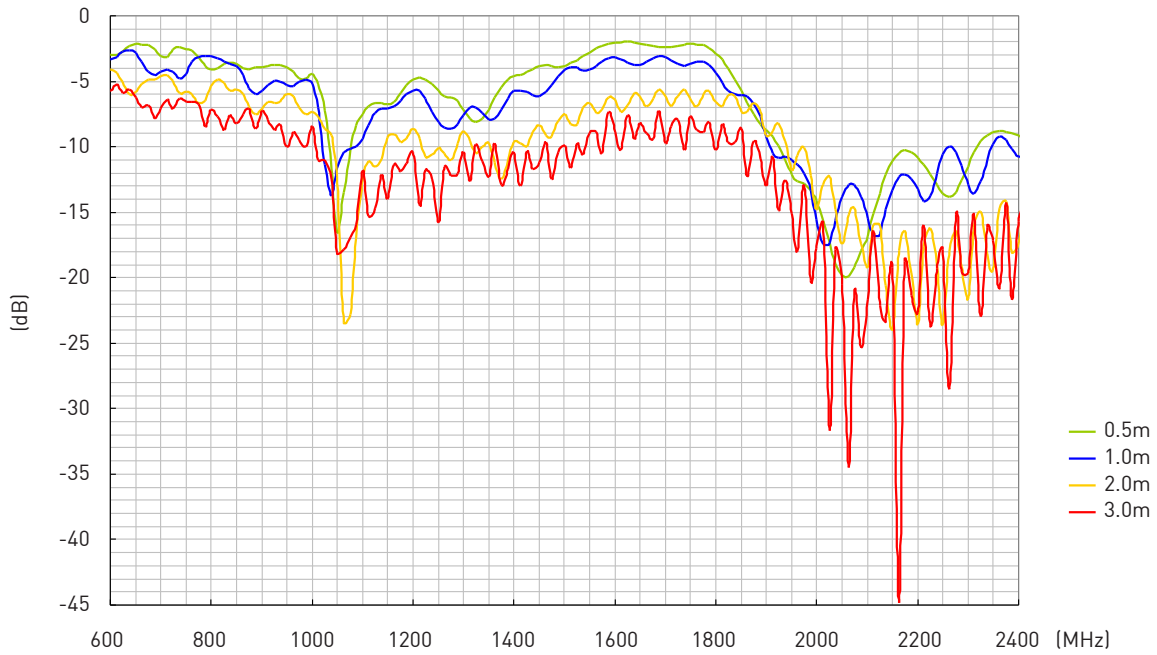

3. S11 Property of GSA.8821 with RG.174 Cable

3.2 Return Loss of GSA.8821 Mounted on Glass

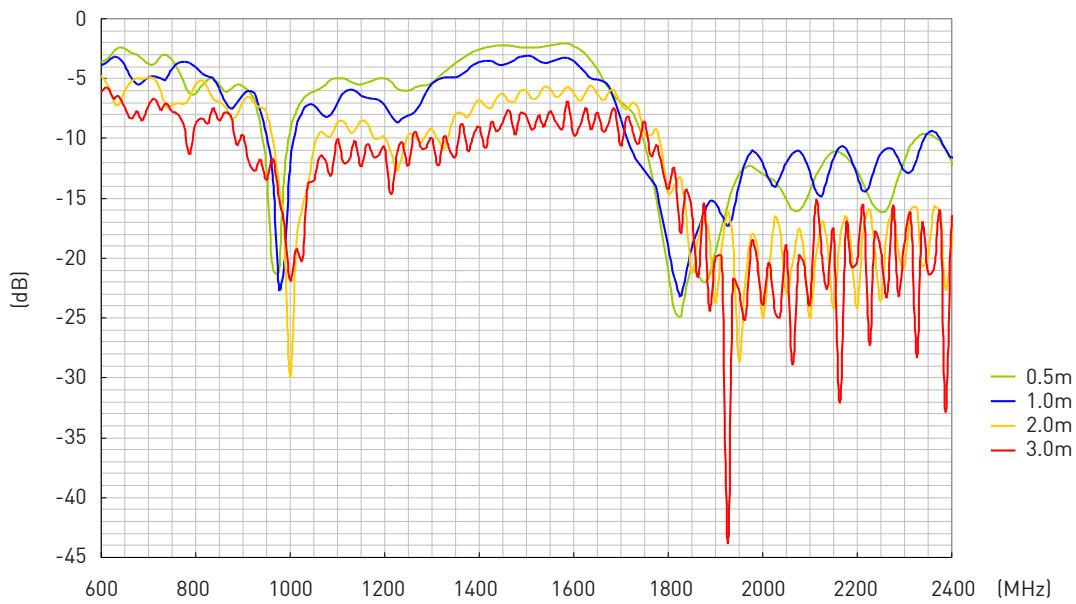

3.3 Return Loss of GSA.8821 Mounted on ABS

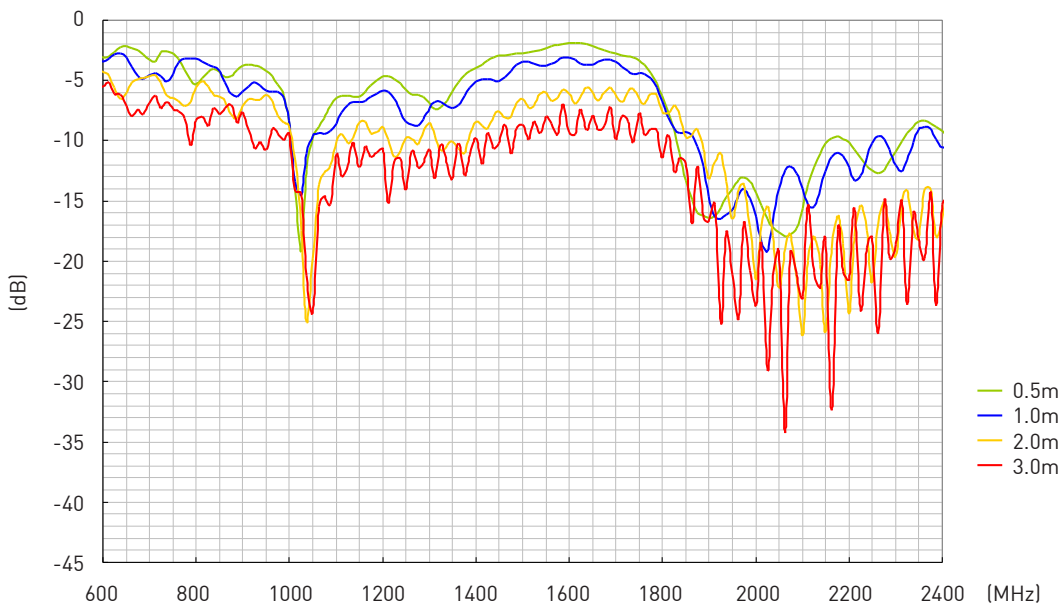

4. Free Space Antenna 3D Radiation Property

4.1 Efficiency of GSA.8821 with RG.174 Cable

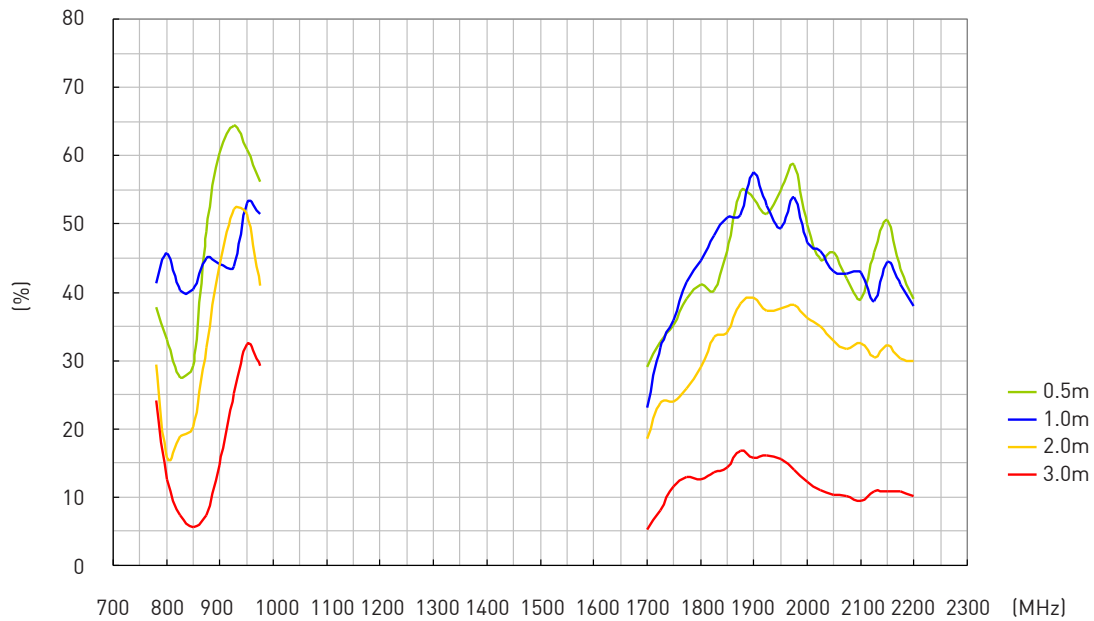

4.1.1 Efficiency of GSA.8821 with 3M RG-174 960~1700MHz

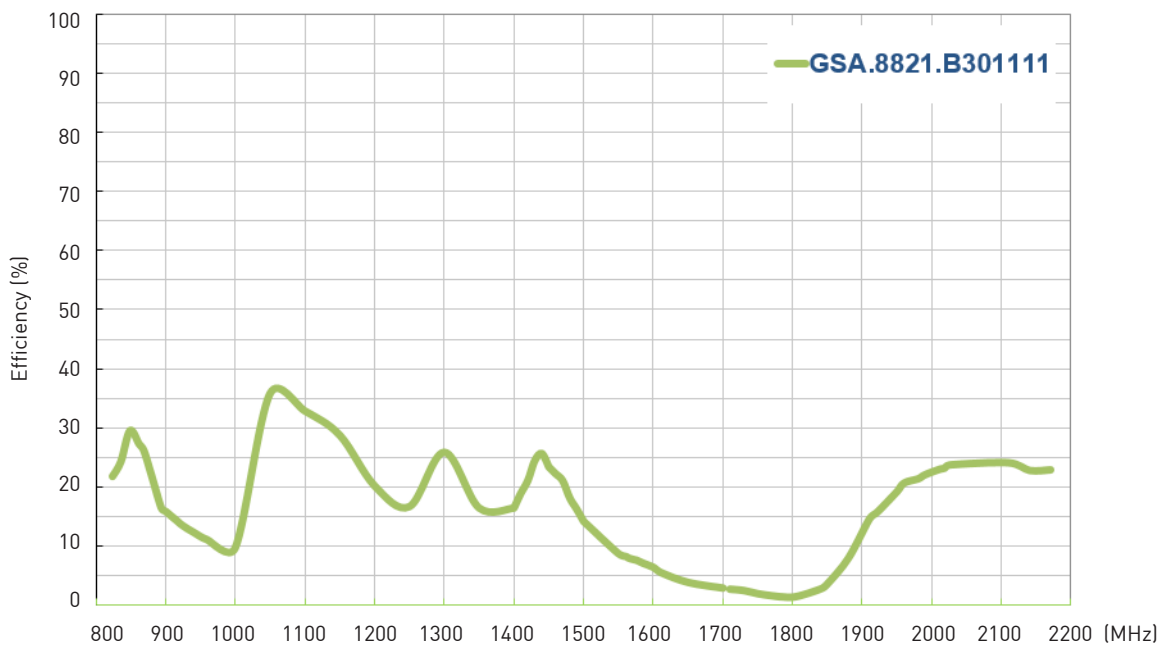

4.2 Peak Gain of GSA.8821 with RG.174 Cable

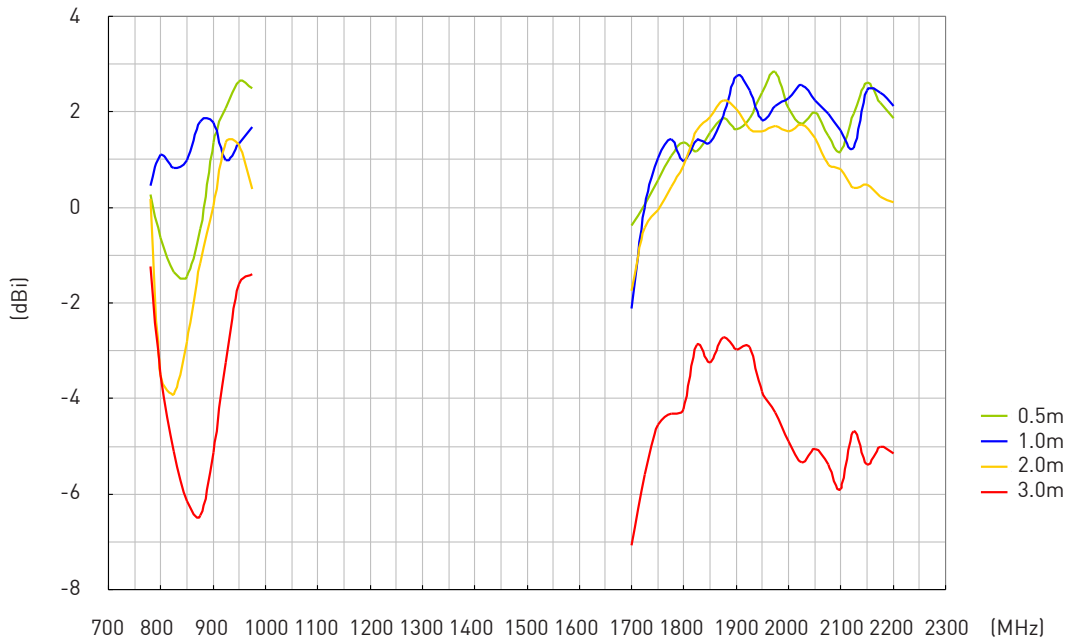

4.2.1 Peak Gain of GSA.8821 with 3M RG-174 960~1700MHz

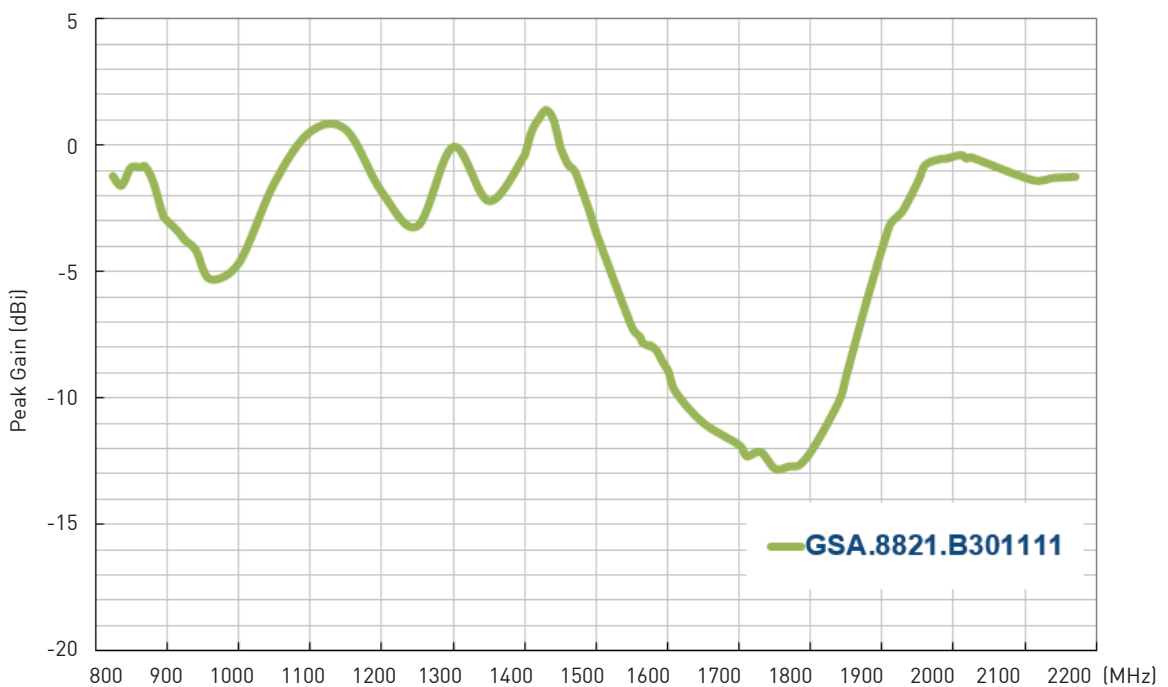

4. Free Space Antenna 3D Radiation Property

4.3 Average Gain of GSA.8821 with RG.174 Cable

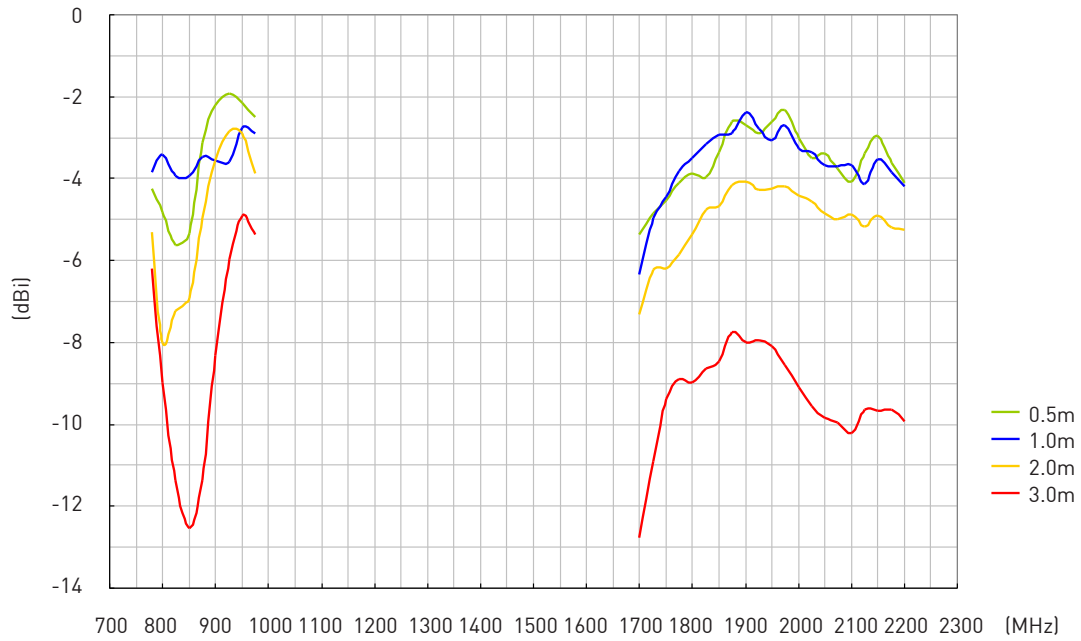

5. Radiation Pattern

5.1 Horizontal H-Plane Radiation of GSA.8821 with 0.5m RG.174 Cable

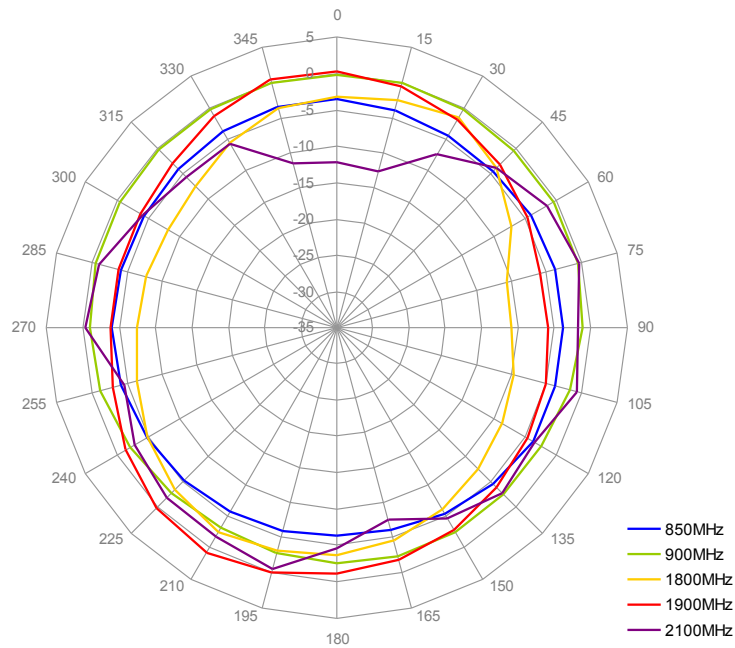

5.2 Vertical E-Plane Radiation of GSA.8821 with 0.5m RG.174 Cable

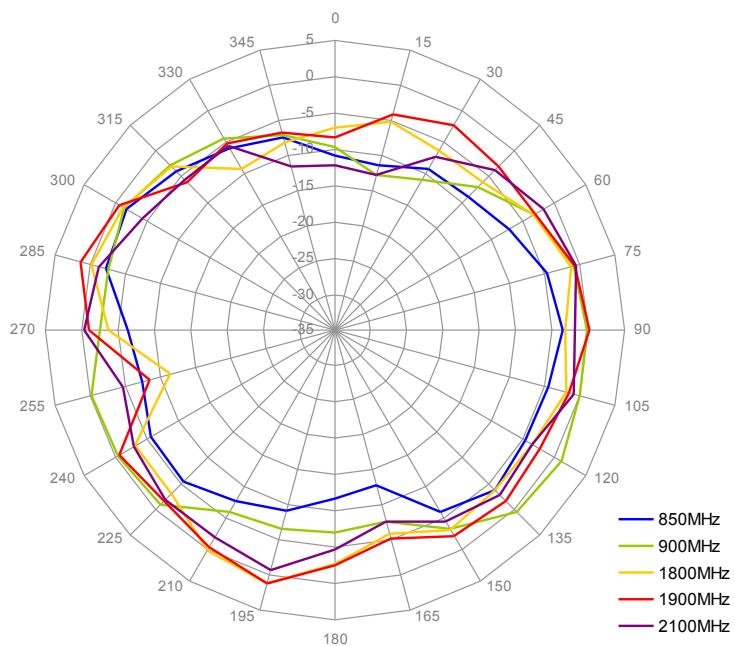

5. Radiation Pattern

5.3 Horizontal H-Plane Radiation of GSA.8821 with 1.0m RG.174 Cable

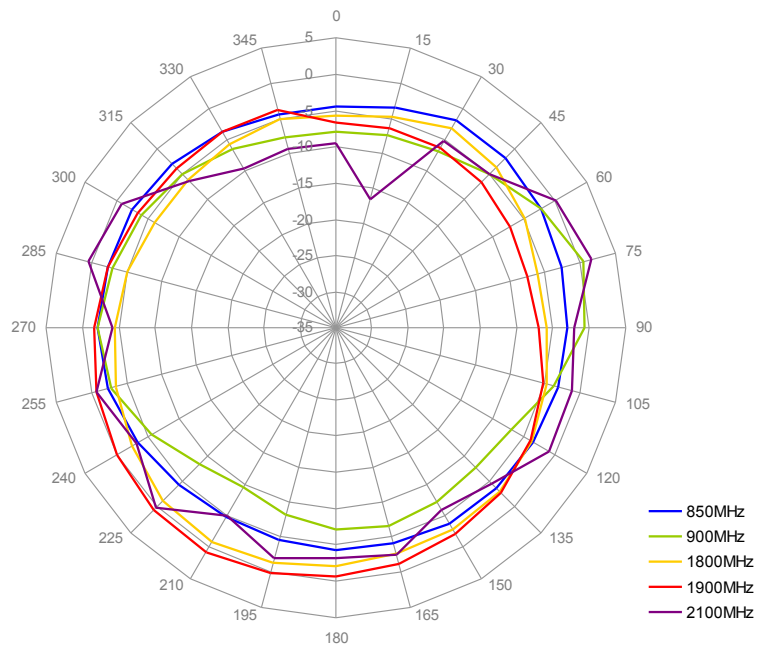

5.4 Vertical E-Plane Radiation of GSA.8821 with 1.0m RG.174 Cable

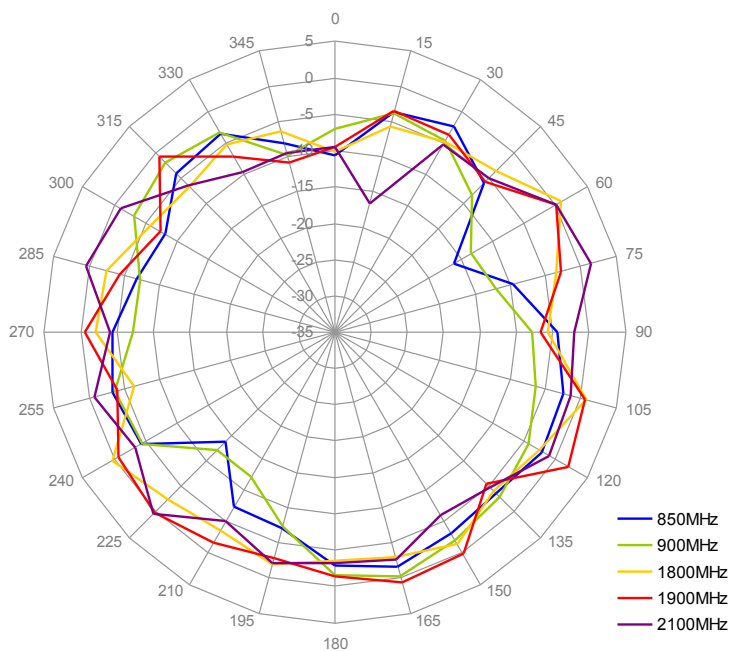

5. Radiation Pattern

5.5 Horizontal H-Plane Radiation of GSA.8821 with 2.0m RG.174 Cable

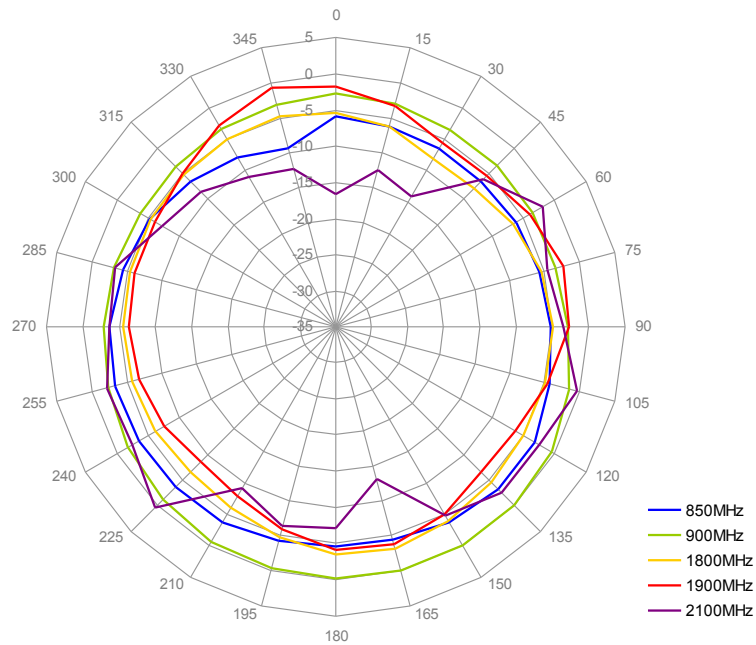

5.6 Vertical E-Plane Radiation of GSA.8821 with 2.0m RG.174 Cable

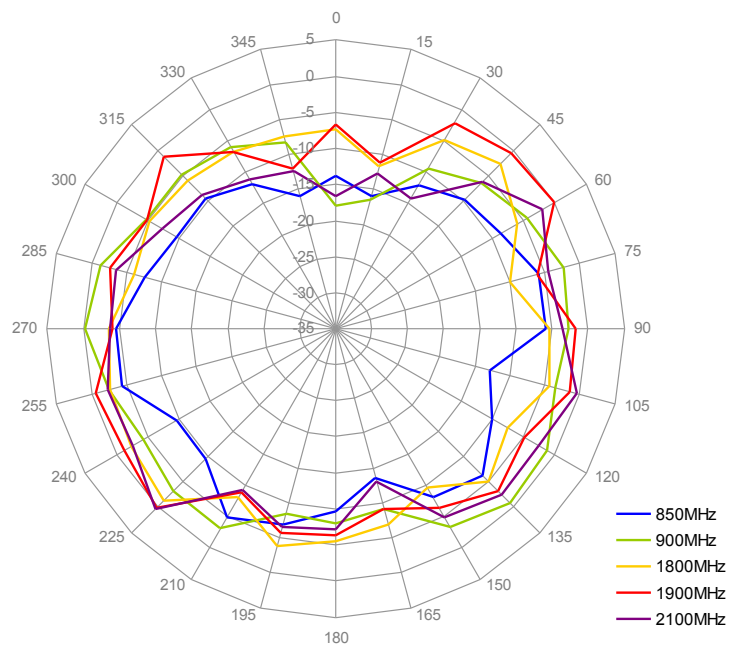

5. Radiation Pattern

5.7 Horizontal H-Plane Radiation of GSA.8821 with 3.0m RG.174 Cable

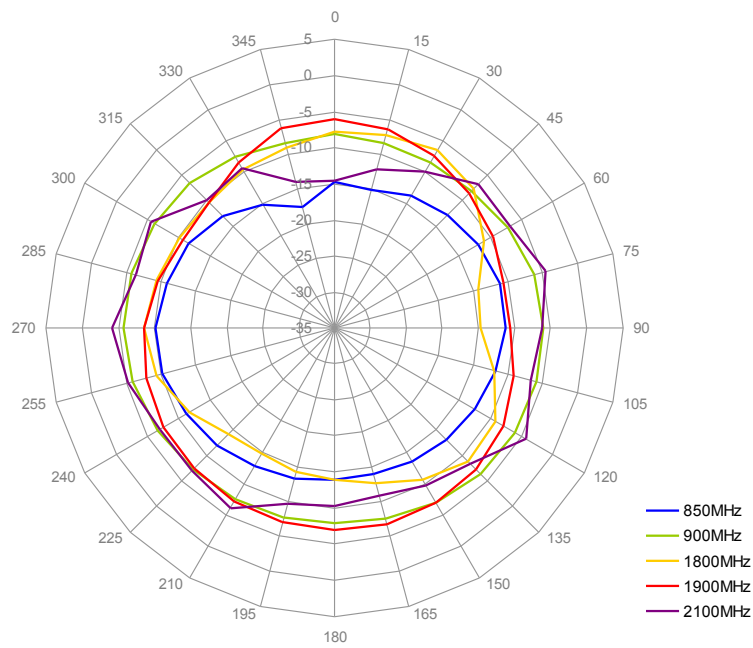

5.8 Vertical E-Plane Radiation of GSA.8821 with 3.0m RG.174 Cable

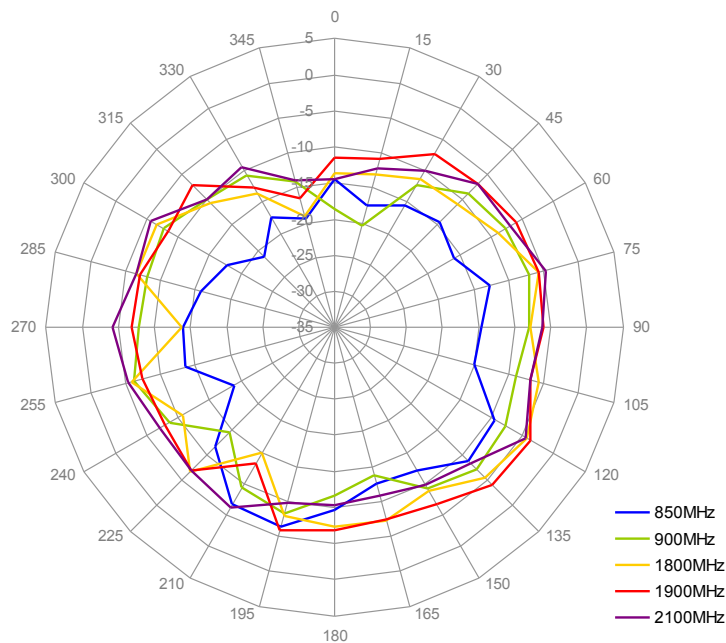

6. Mechanical Drawing

	Name	Material	Finish	QTY
1	Housing	ABS PA757	Black	1
2	Double Sided Adhesive	3M 1600T	Gray	1
3	GSM Label	Coated Paper	Blue	1
4	Heat Shrink Tube	PE	Black	1

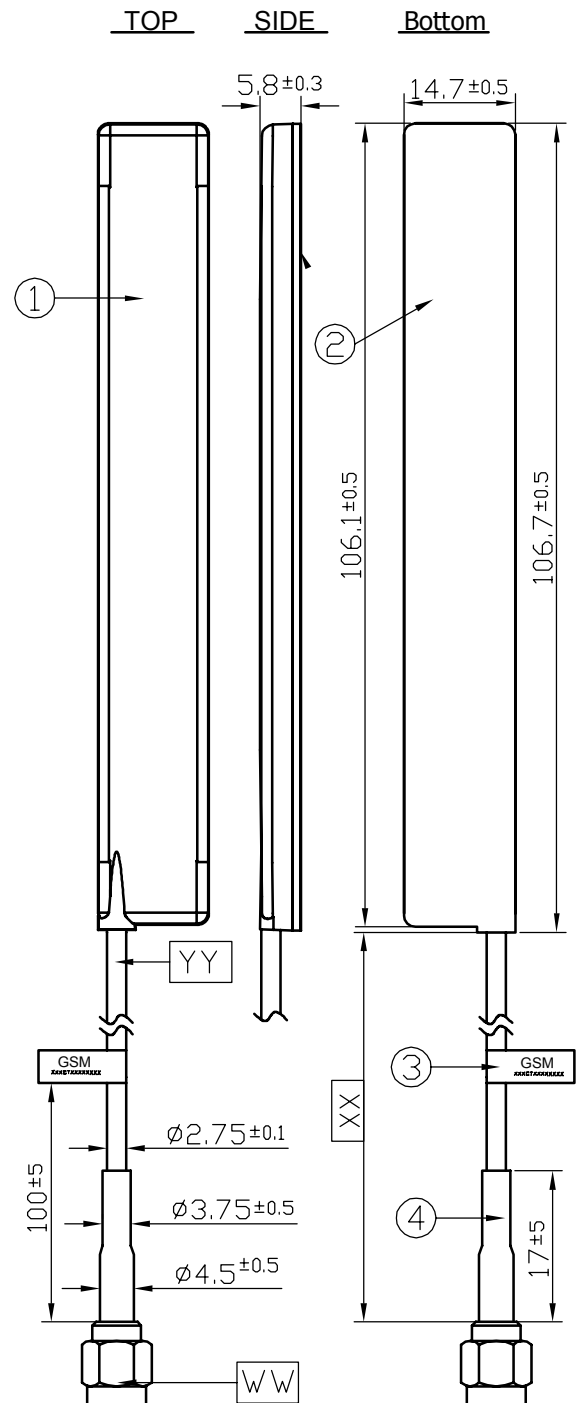
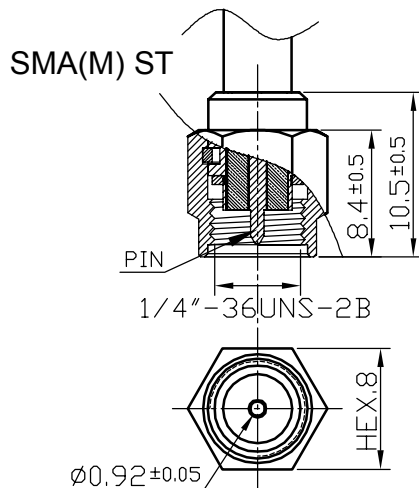

7. Packaging

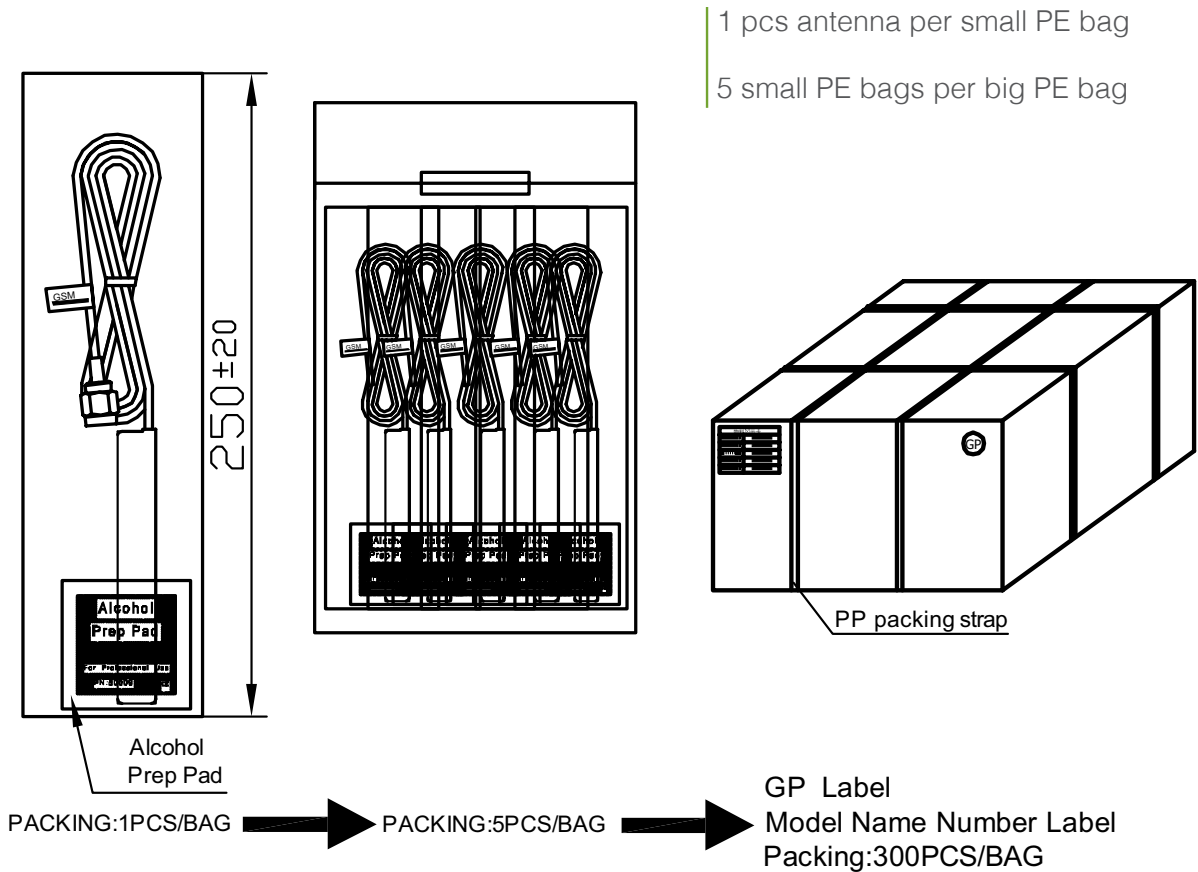

Taoglas makes no warranties based on the accuracy or completeness of the contents of this document and reserves the right to make changes to specifications and product descriptions at any time without

notice. Taoglas reserves all rights to this document and the information contained herein.

Reproduction, use or disclosure to third parties without express permission is strictly prohibited.

Copyright © Taoglas Ltd.