



TAOGLAS®



Datasheet

Bolt

Part No:
A.85.A.101111

Description:

Bolt-Multi-Bands Low Profile
GPS(L5)/ GPS(L1), Galileo(E1), GLONASS(G1), BeiDou(B1)
Permanent Mount Antenna with High Out of Band Rejection

Features:

30dB GPS(L5) Gain, 28dB GNSS(L1) Gain
>80dB@850/900MHz,
>65dB@1,800/1,900MHz
Lightning Induced Surge Protection
Wideband Input Voltage
Permanent (Screw) Mount
Low Profile, Vandal Resistant Design
IP67 Rated, UV Resistant Enclosure
Cable: 1m RG-174
Connector: SMA (M) ST
Dimensions: Diameter: 94.3mm, Height: 25.4mm
RoHS & Reach Compliant

1. Introduction	3
2. Specifications	4
3. Antenna Characteristics	7
4. Radiation Patterns	13
5. Active Characteristics	18
6. Mechanical Drawing	21
7. Mechanical Drawing	22
8. Packaging	23
<hr/>	
Changelog	25

Taoglas makes no warranties based on the accuracy or completeness of the contents of this document and reserves the right to make changes to specifications and product descriptions at any time without notice. Taoglas reserves all rights to this document and the information contained herein. Reproduction, use or disclosure to third parties without express permission is strictly prohibited.



1. Introduction



The Bolt, A.85 is a high gain GNSS L1/L5 (GPS/GLONASS/Galileo/BeiDou) antenna that features very high out of band rejection and can handle large bursts of power from nearby transmitters allowing the antenna to always remain operational. These characteristics make the A.85 ideal for applications where the antenna will be placed near high-power transmitters.

Typical Applications Include:

- Commercial Transportation
- Asset and Container Tracking
- Small Cell GNSS Towers
- Precision Agriculture

The A.85 Bolt L1 and L5 GNSS permanent mount antenna utilizes a very high efficiency (>60%) patch antenna that has been tuned for best possible performance within the enclosure to maximize signal quality. The internal LNAs have very low noise figure to maintain excellent signal quality throughout the entire signal chain. The signal chain also features carefully selected and placed SAW filters that collectively allow for very sharp signal attenuation outside of the intended frequency bands without negatively impacting in-band signal quality.

The A.85 features excellent rejection across all non-GNSS frequencies to prevent overdriving or damaging your GPS receiver. At the 850/900MHz cellular bands, for example, the A.85 exhibits greater than 50dB of rejection. At the 1800/1900MHz cellular bands, it exhibits >65dB, making it best in class when out of band interference is a concern. Even with this excellent out of band attenuation, the A.85 maintains a low noise figure of 4dB and high gain of >21dB, making it an ideal solution for applications with longer cable runs where high cable loss is a concern.

Cable lengths and connector types are customizable. Contact your regional Taoglas customer support team for further information.

2. Specifications

GNSS Frequency Bands					
GPS	L1 1575.42 MHz	L2 1227.6 MHz	L5 1176.45 MHz		
	■	□	■		
GLONASS	G1 1602 MHz	G2 1248 MHz	G3 1207 MHz		
	■	□	□		
Galileo	E1 1575.24 MHz	E5a 1176.45 MHz	E5b 1201.5 MHz	E6 1278.75 MHz	
	■	■	□	□	
BeiDou	B1C 1575.42 MHz	B1I 1561 MHz	B2a 1176.45 MHz	B2b 1207.14 MHz	B3 1268.52 MHz
	■	■	□	□	□
L-Band	L-Band 1542 MHz				
	□				
QZSS (Regional)	L1 1575.42 MHz	L2C 1227.6 MHz	L5 1176.45 MHz	L6 1278.75e6	
	■	□	■	□	
IRNSS (Regional)	L5 1176.45 MHz				
	□				
SBAS	L1/E1/B1 1575.42 MHz	L5/B2a/E5a 1176.45 MHz	G1 1602 MHz	G2 1248 MHz	G3 1207 MHz
	■	■	■	□	□

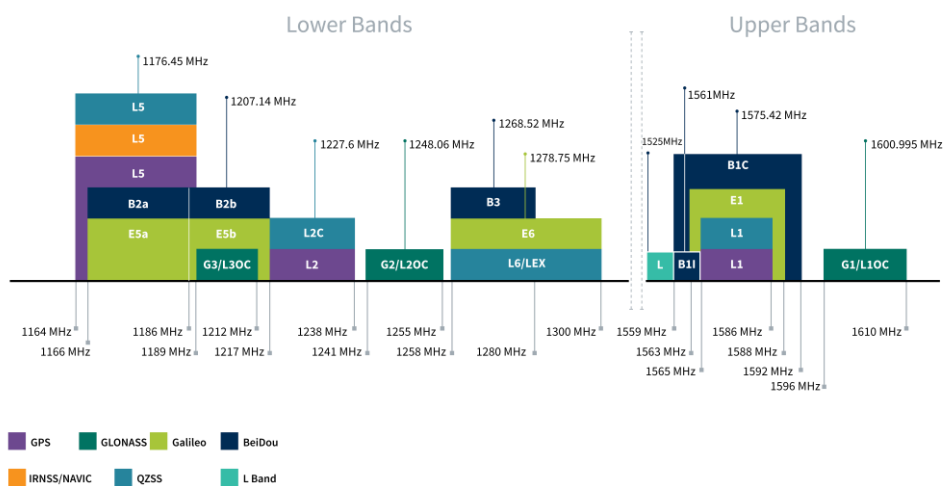

GNSS Bands and Constellations

Electrical					
Frequency (MHz)	GPS_L5	BeiDou_B1	Galileo_E1	GPS_L1C	GLONASS_L1
	1166-1186	1559-1563	1563-1587	1569-1581	1569-1605
Efficiency (%)					
Free-Space	61.5	41.5	68.0	68.0	62.9
On-30x30cm	51.4	35.5	57.7	57.7	54.4
Average Gain (dB)					
Free-Space	-2.11	-3.82	-1.67	-1.67	-2.01
On-30x30cm	-2.89	-4.50	-2.39	-2.39	-2.64
Peak Gain (dBi)					
Free-Space	3.70	0.52	2.72	2.72	2.83
On-30x30cm	2.78	2.34	4.40	4.40	4.50
PCO (cm)					
Free-Space	1.0	0.9	0.9	0.9	0.9
On-30x30cm	1.8	1.4	1.4	1.4	1.4
PCV (cm)					
Free-Space	2.3	1.2	1.2	1.2	1.2
On-30x30cm	6.3	8.6	8.6	8.6	8.6
Impedance	50 Ω				
Polarization	Right-Hand Circularly Polarized (RHCP)				
Radiation Pattern	Omni-Directional				
Max. input power	5 W				
LNA and Filter Electrical Properties					
Frequency (MHz)	1176.45	1561	1575.42	1602	
Return Loss (dB)	-7	-9	-15	-12	
Gain @ 3V (dB)	30	28	28	28	
Noise @ 3V (dB)	2.5	2.6	2.4	2.2	
Group Delay (ns)	28.1	26.7	25.2	28.0	
DC Power Input (V)	1.8 ~ 5.5				
Power consumption @3V (mA)	18				
Outer Band Attenuation (dB) (reference level from 0dB)	40 @ Fc +/-100MHz 50 @ Fc +/-200MHz				
Field Test Result					
RTK Accuracy (cm)	1.9				
CN Value (dB-Hz)	40+				
Non RTK Accuracy (cm)	42.8				

Mechanical	
Dimensions	94.3mm, Height: 25.4mm
Weight	283.5g
Material	ASA
Connector	SMA(M)ST as standard
Cable	1m of RG-174 as standard
Environmental	
Waterproof Rating	IP65
Temperature Range	-40°C to 85°C
Humidity	Non-condensing 65°C 95% RH

3. Antenna Characteristics

3.1 Return Loss

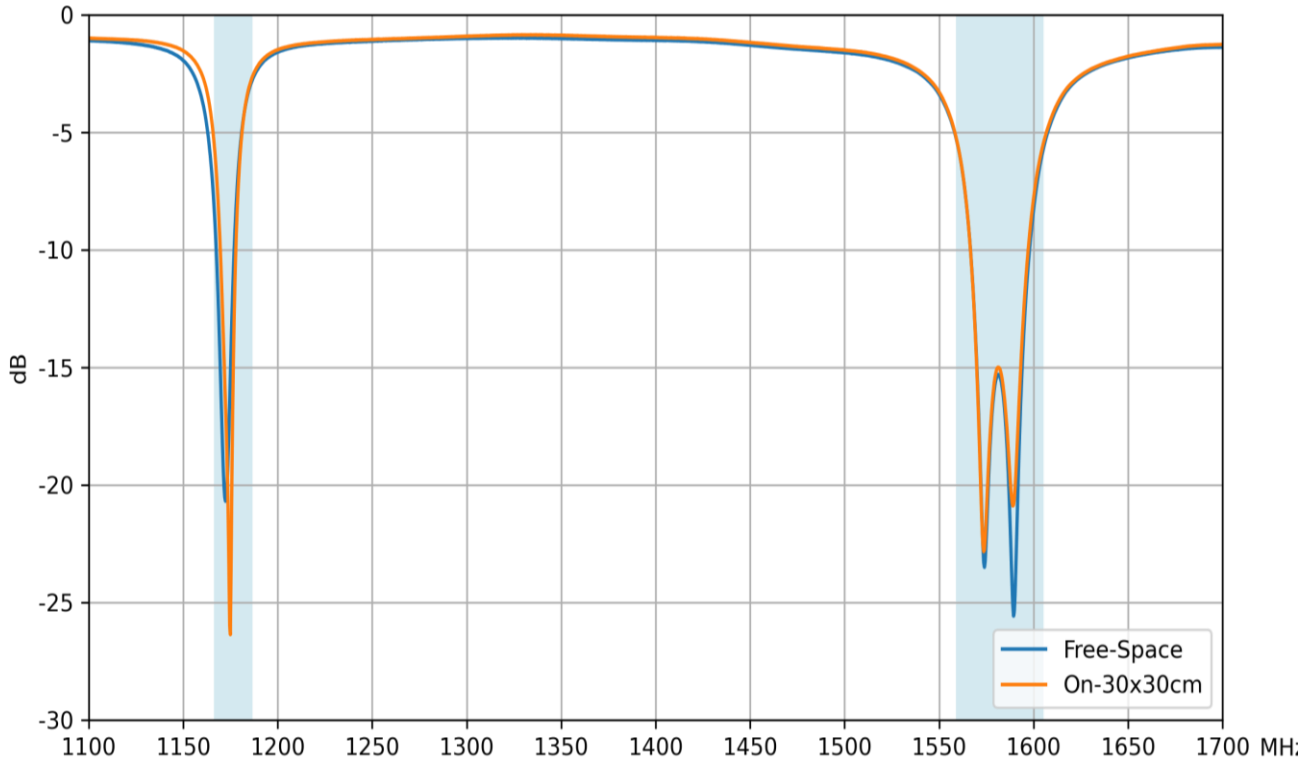

3.2 VSWR

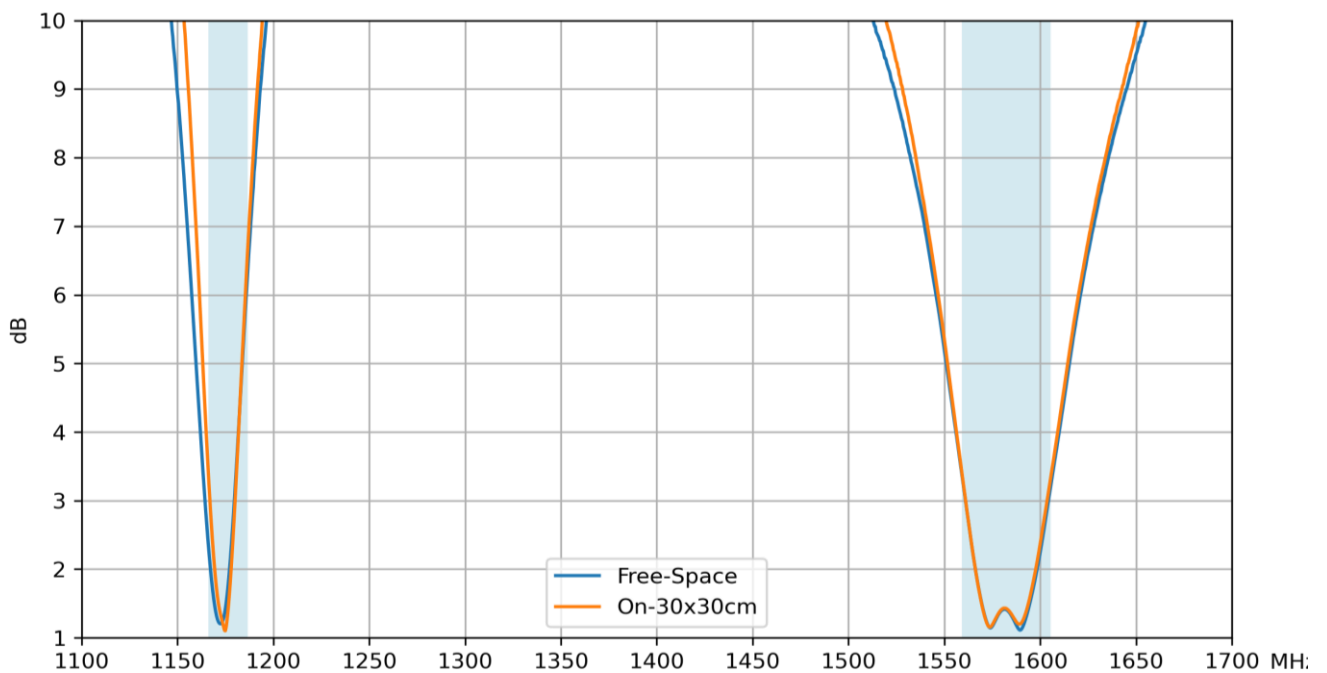

3.3 Efficiency

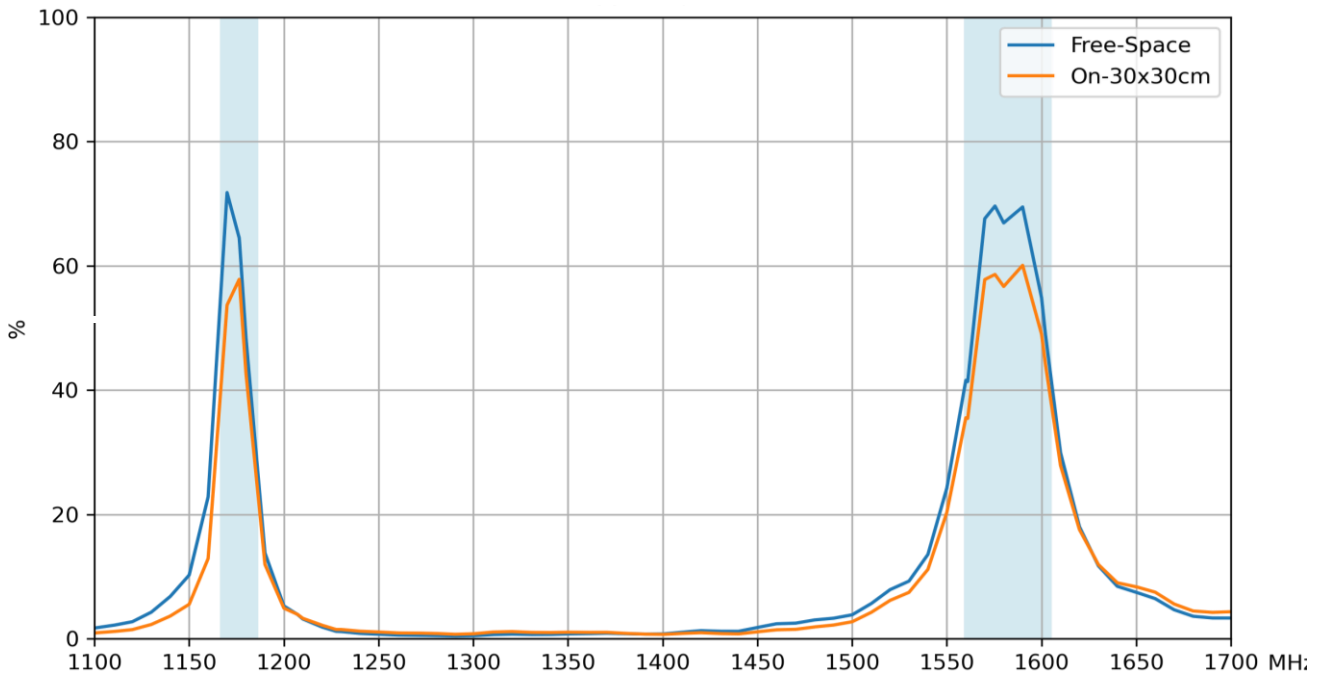

3.4 Average Gain

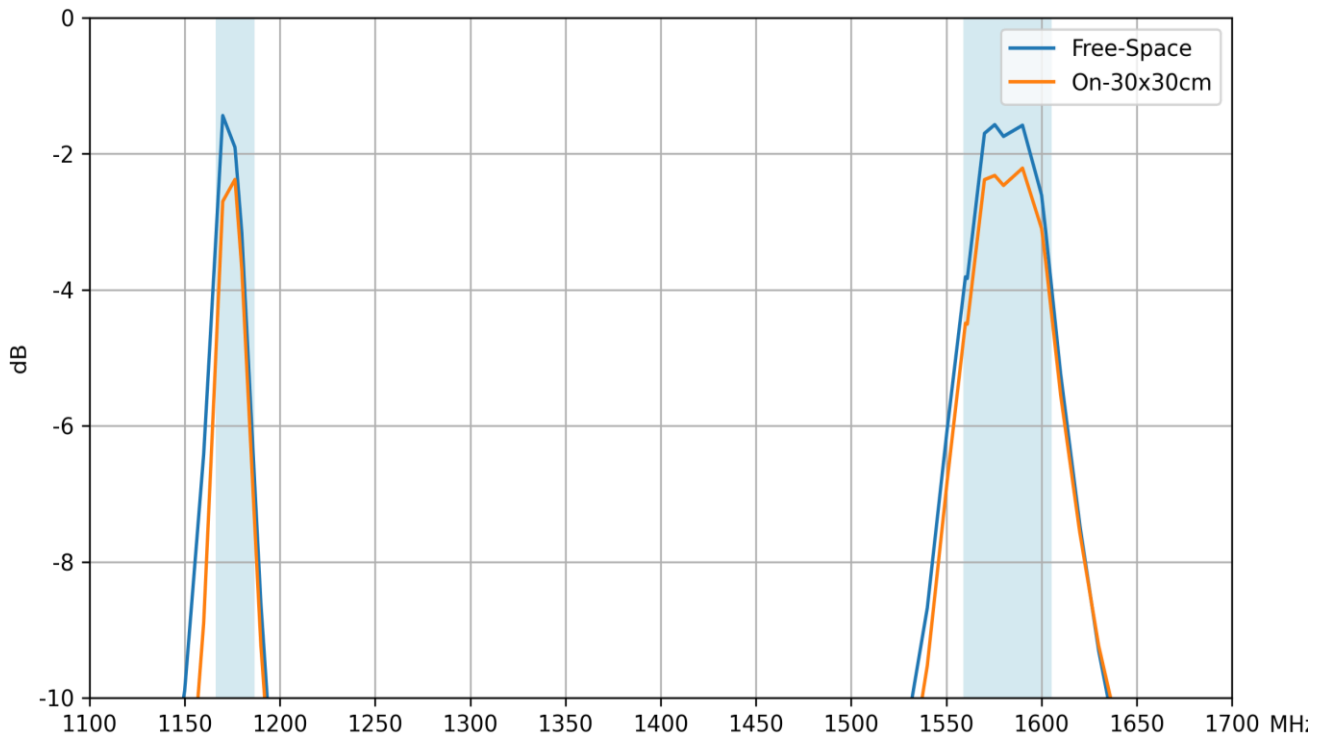

3.5 Peak Gain

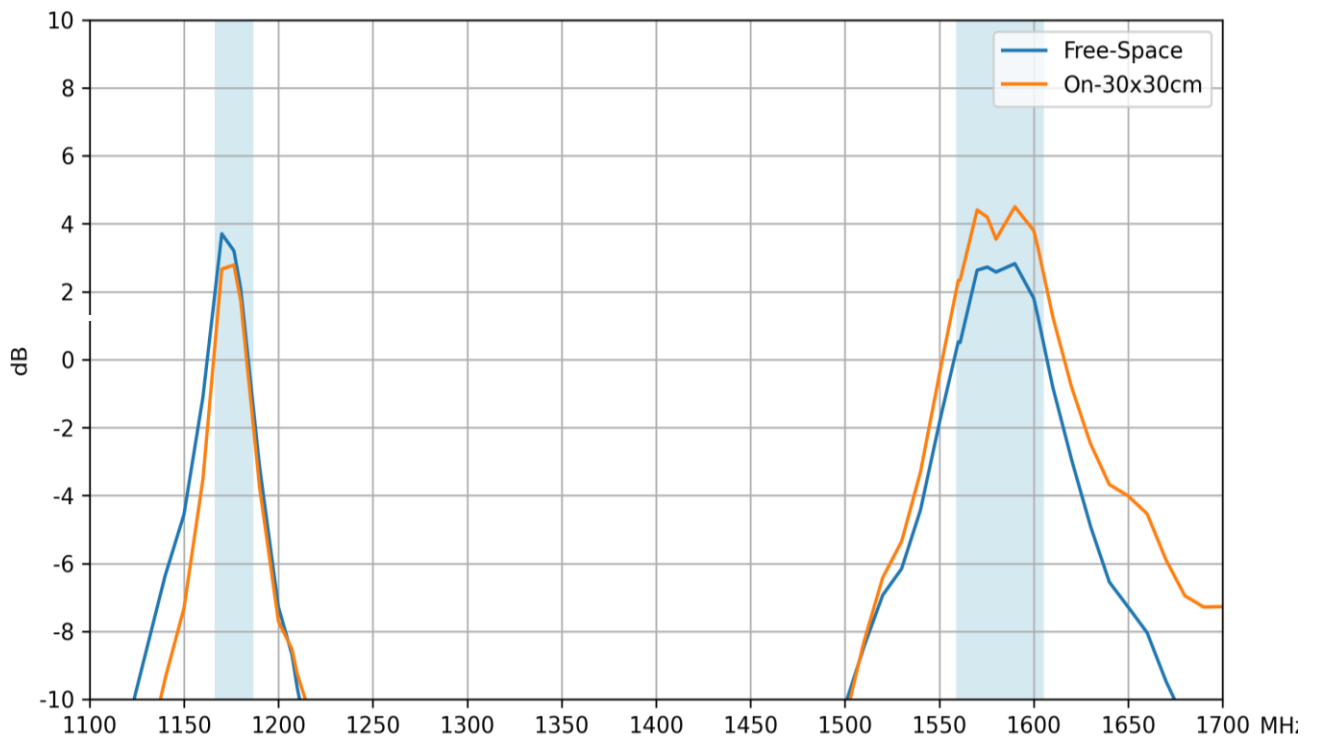

3.6 Axial Ratio

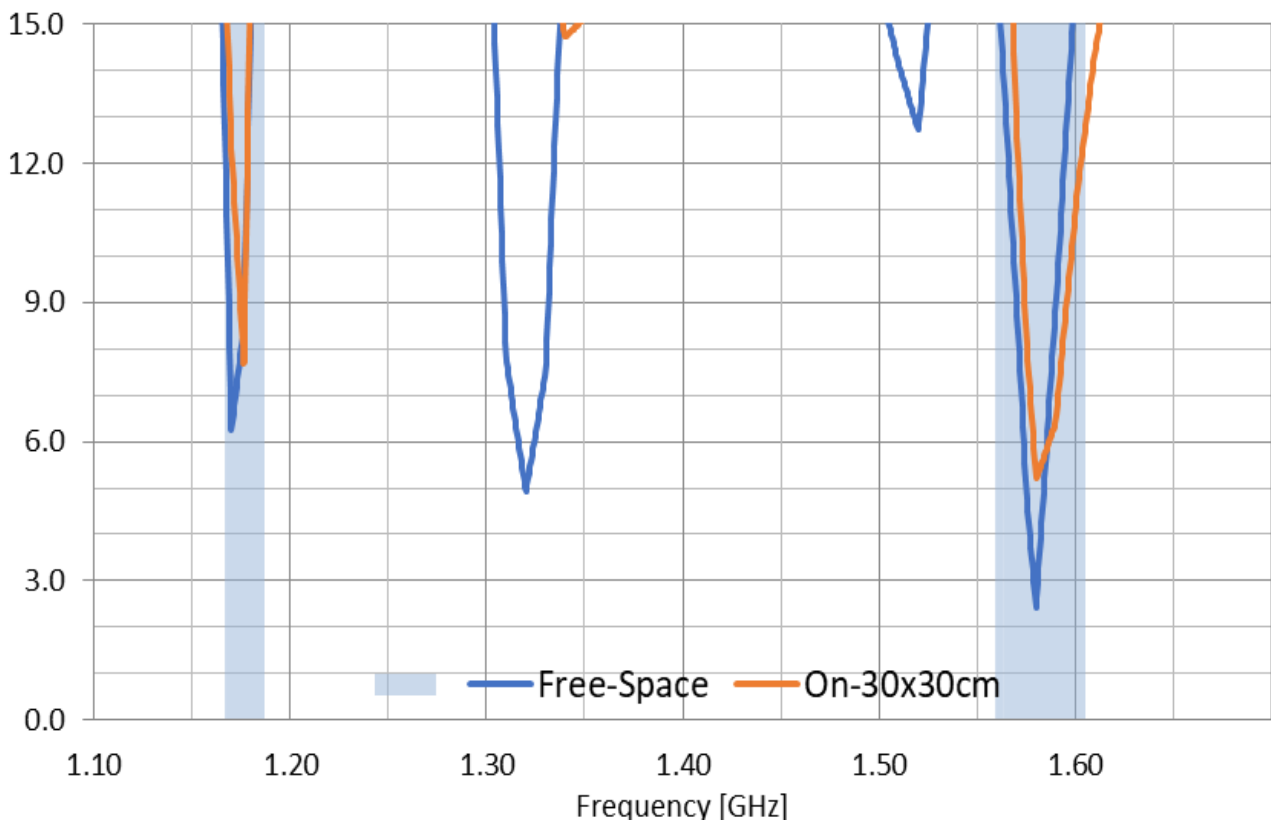

4. Radiation Patterns

4.1 Test Setup

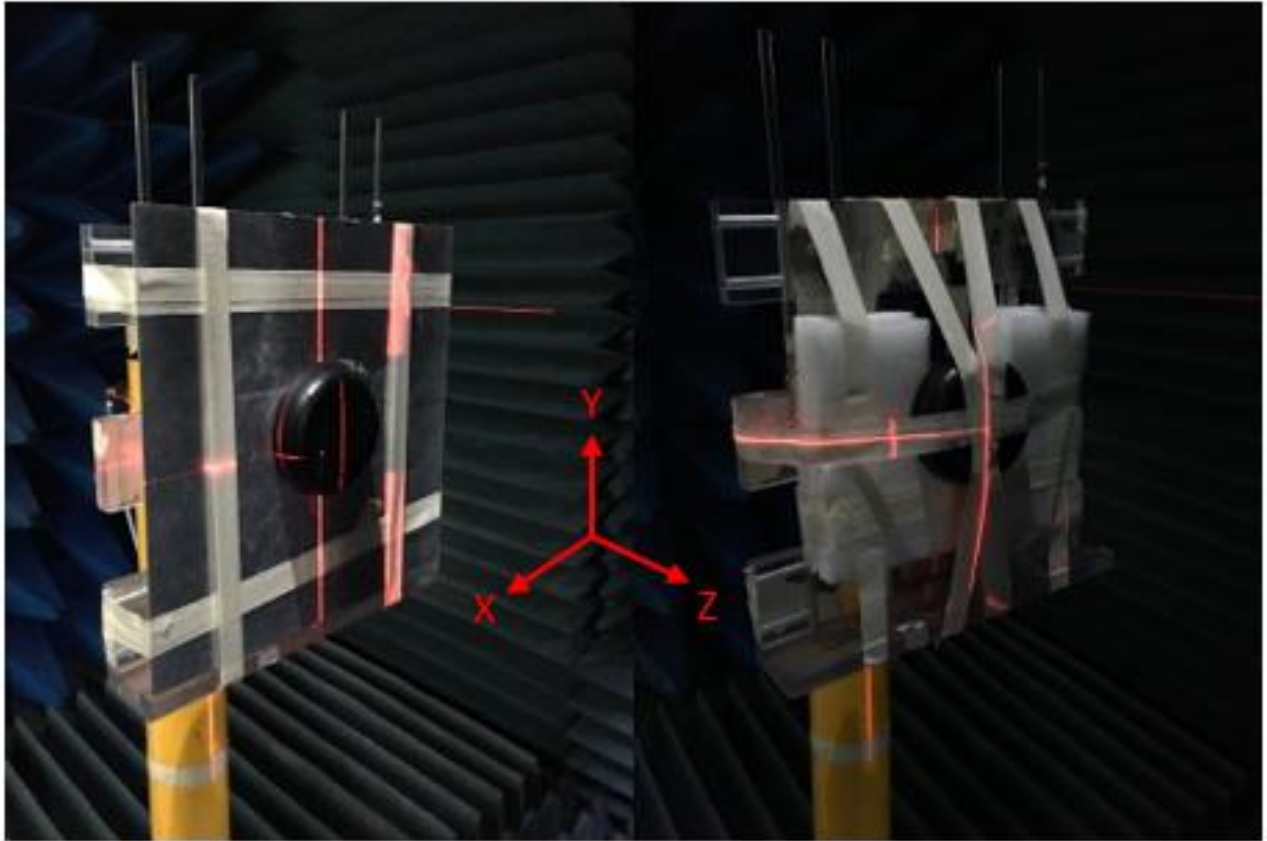

30x30cm Groundplane

Freespace

4.2 1176MHz 3D and 2D Radiation Patterns (Freespace)

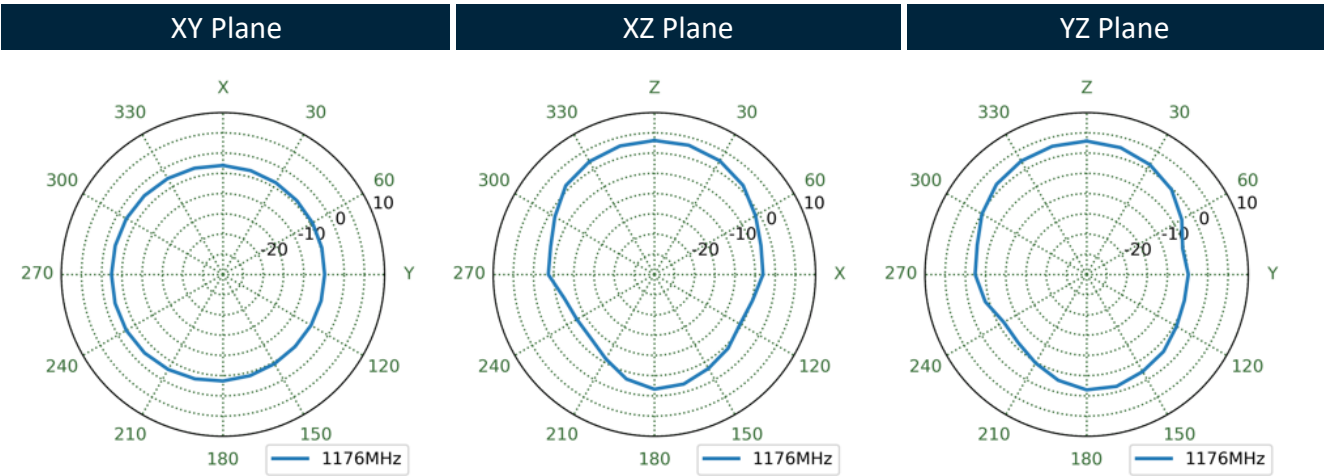
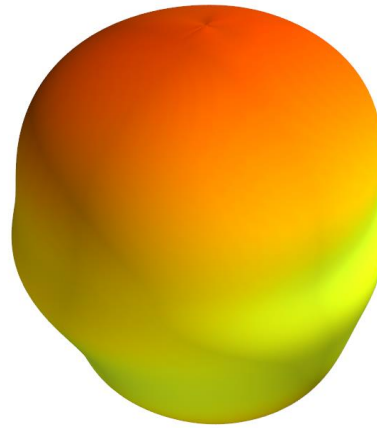

1561MHz

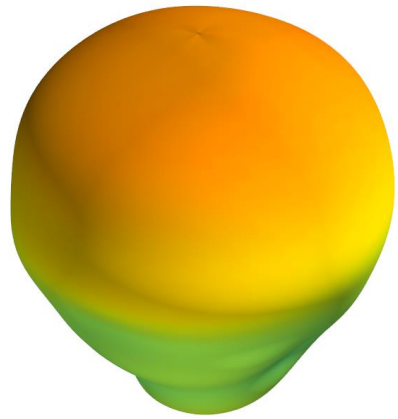

XY Plane

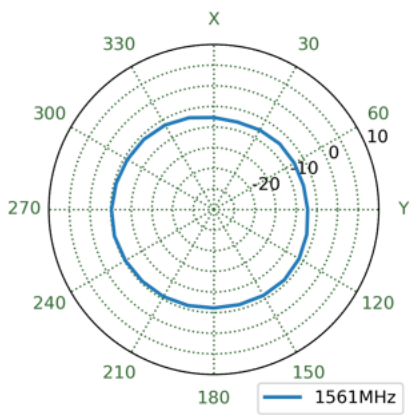

XZ Plane

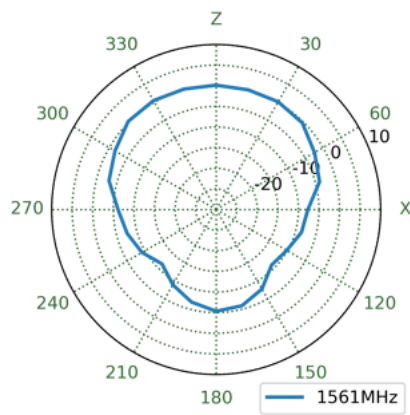

YZ Plane

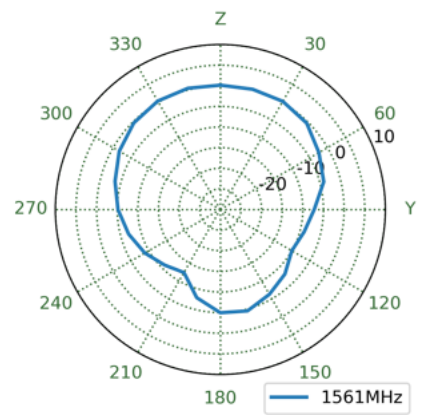

1575MHz

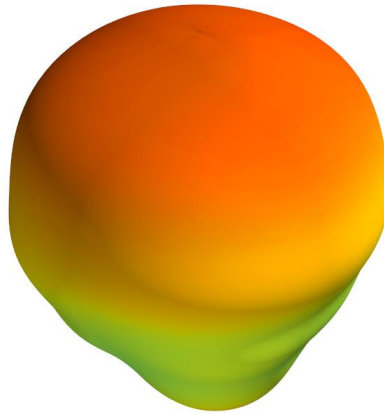

XY Plane

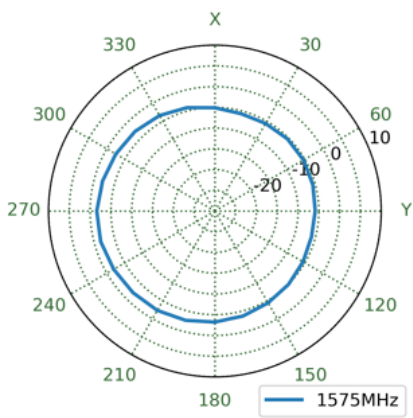

XZ Plane

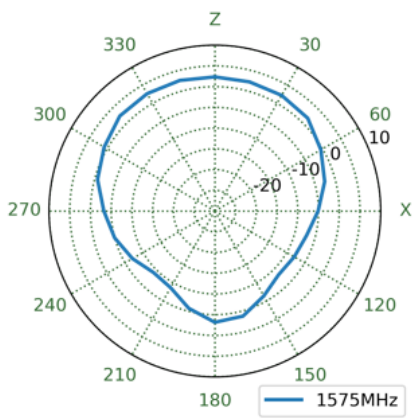

YZ Plane

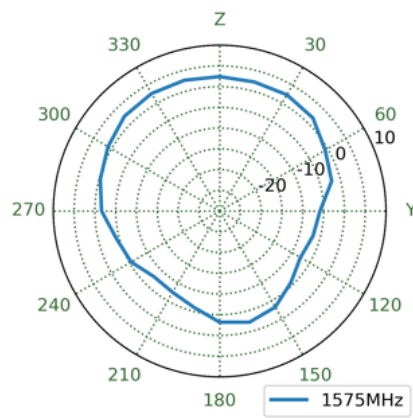

1602MHz

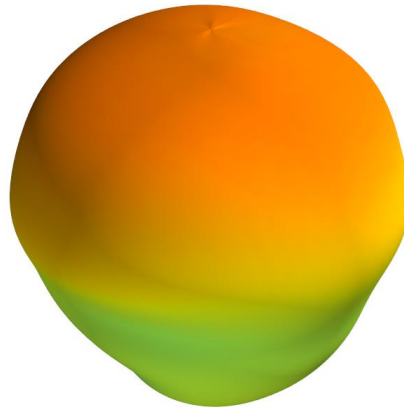

XY Plane

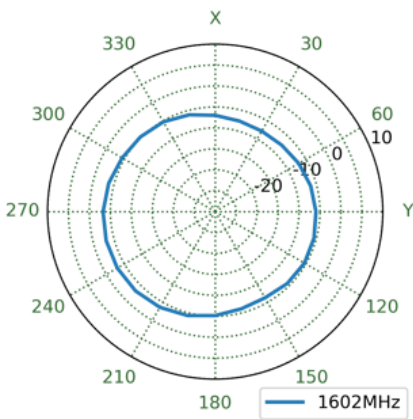

XZ Plane

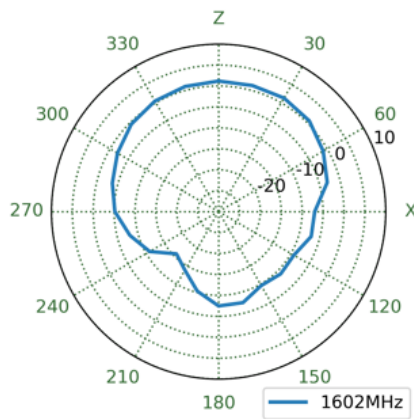

YZ Plane

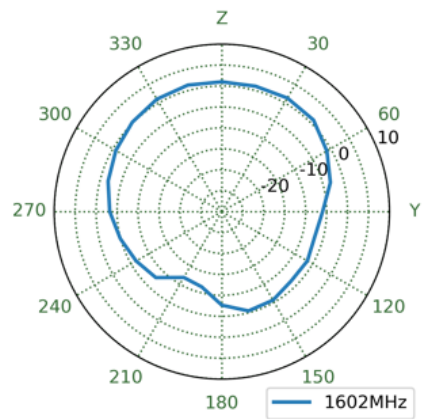

4.3 1176MHz 3D and 2D Radiation Patterns (30x30cm Groundplane)

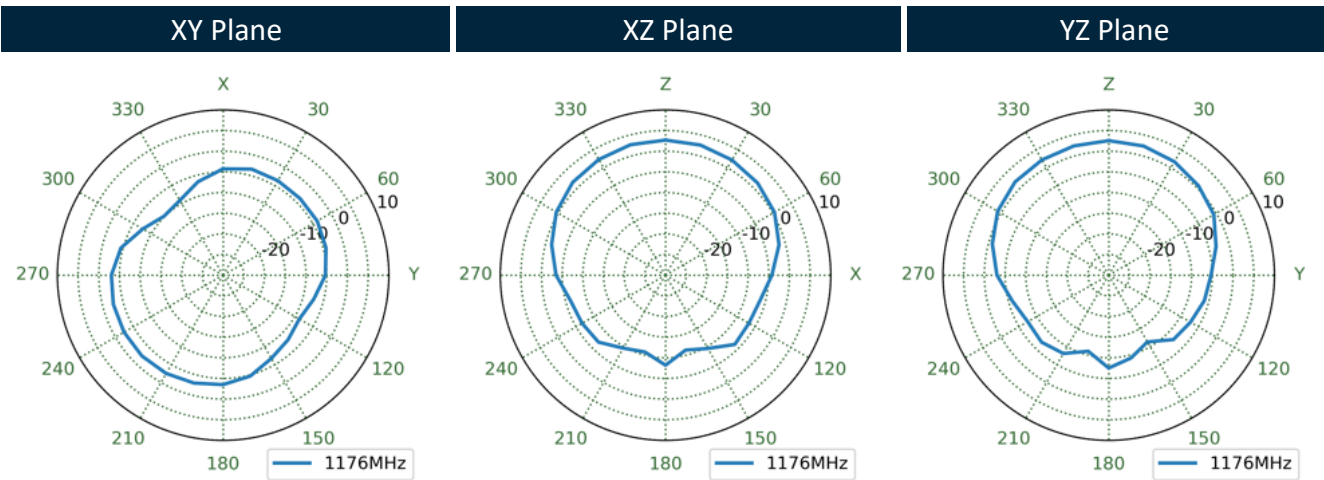
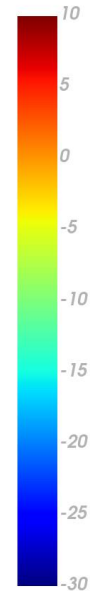
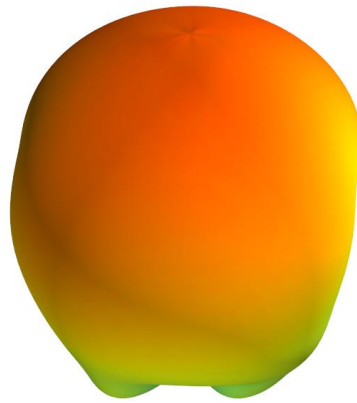

1561MHz

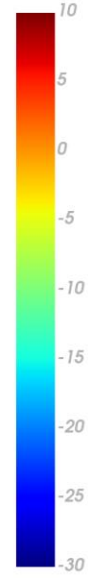
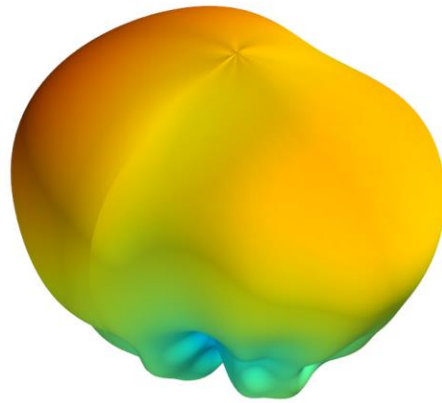

XY Plane

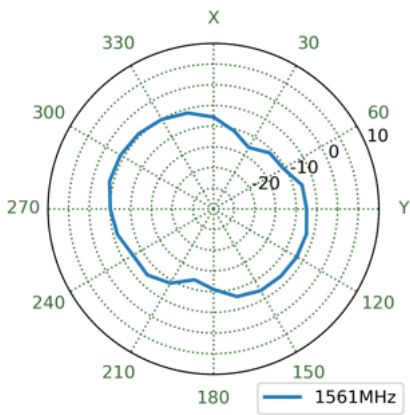

XZ Plane

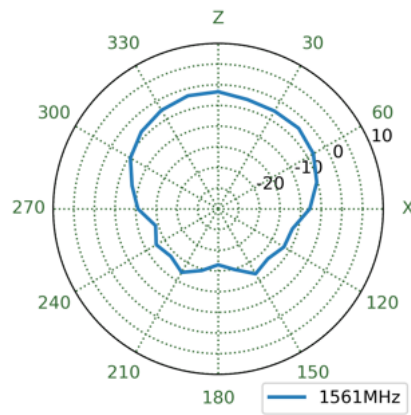

YZ Plane

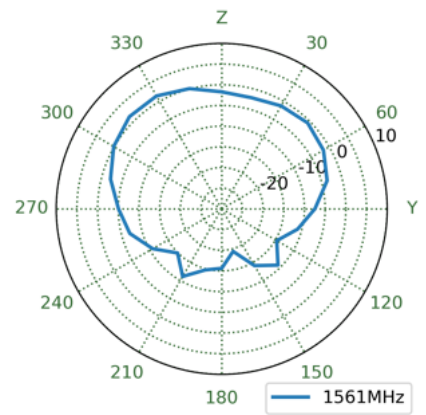

1575MHz

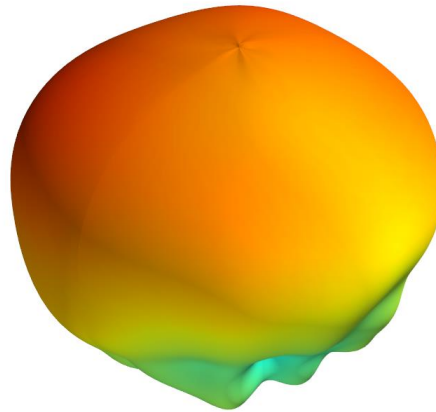

XY Plane

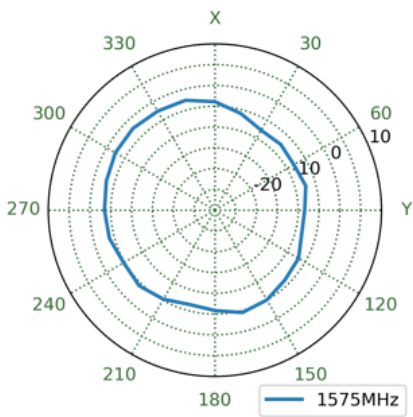

XZ Plane

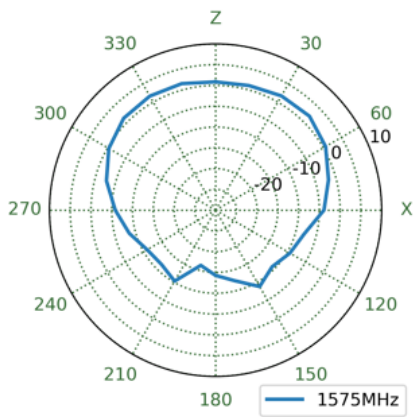

YZ Plane

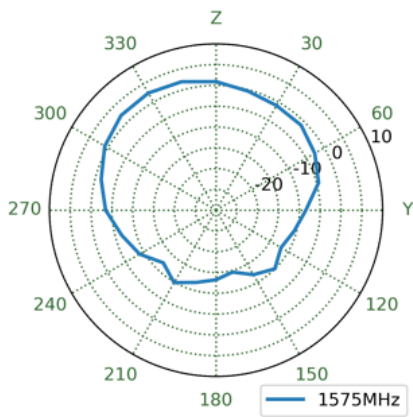

1602MHz

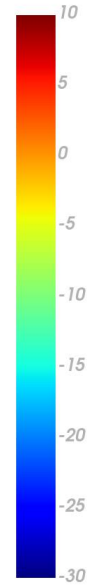
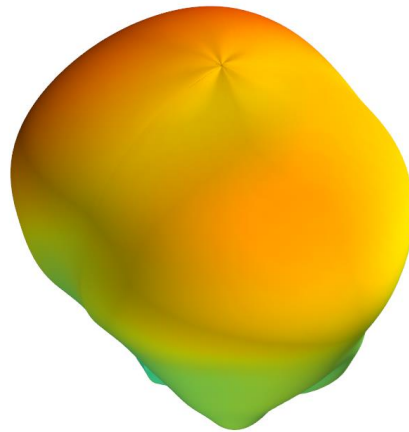

XY Plane

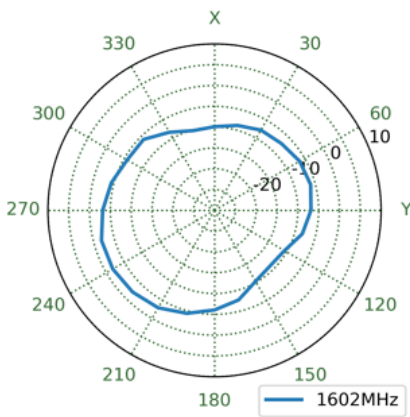

XZ Plane

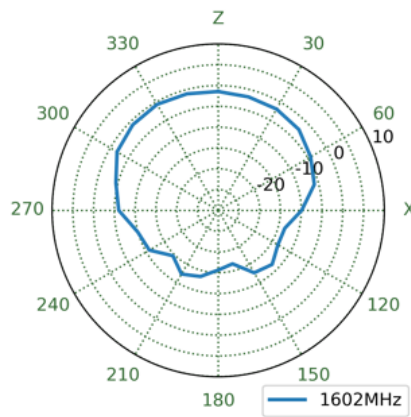

YZ Plane

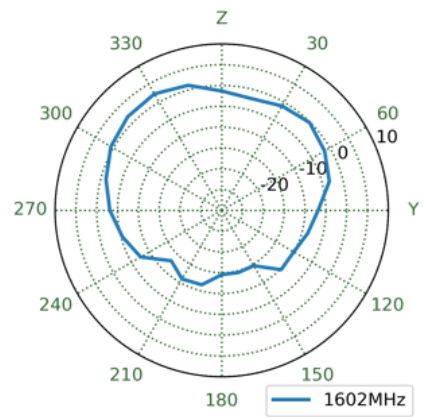

5. Active Characteristics

5.1 Block Diagram (LNA)

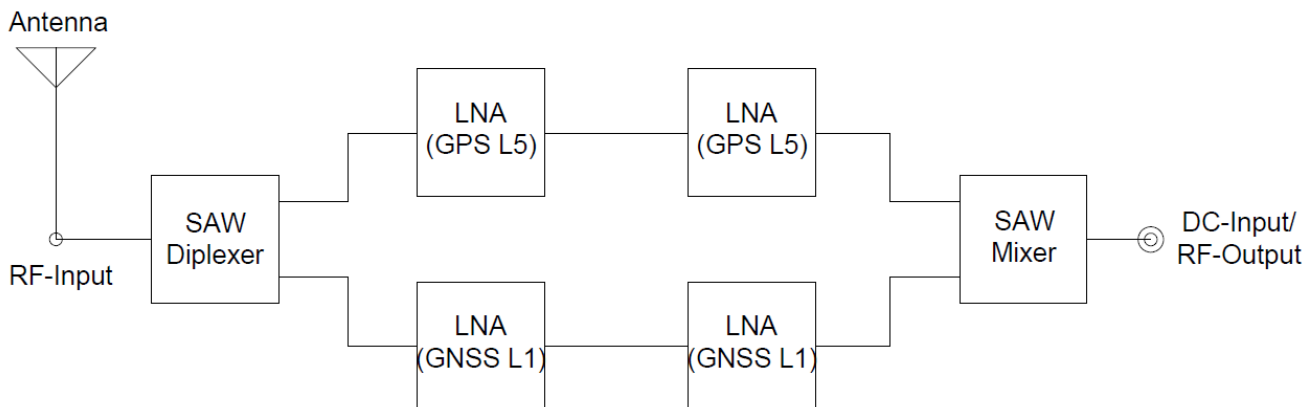

5.2 LNA – Out of Band Rejection 1.1GHz to 1.7GHz

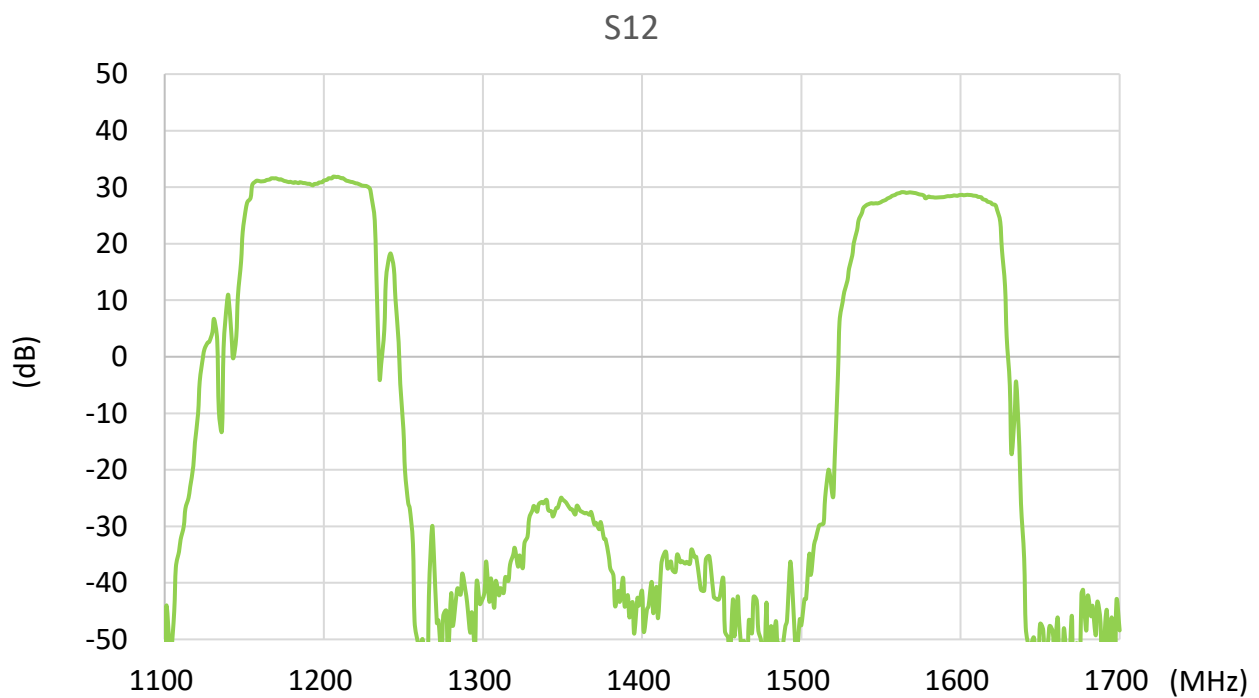

5.3 LNA - Out of band Rejection 0.5GHz to 6GHz

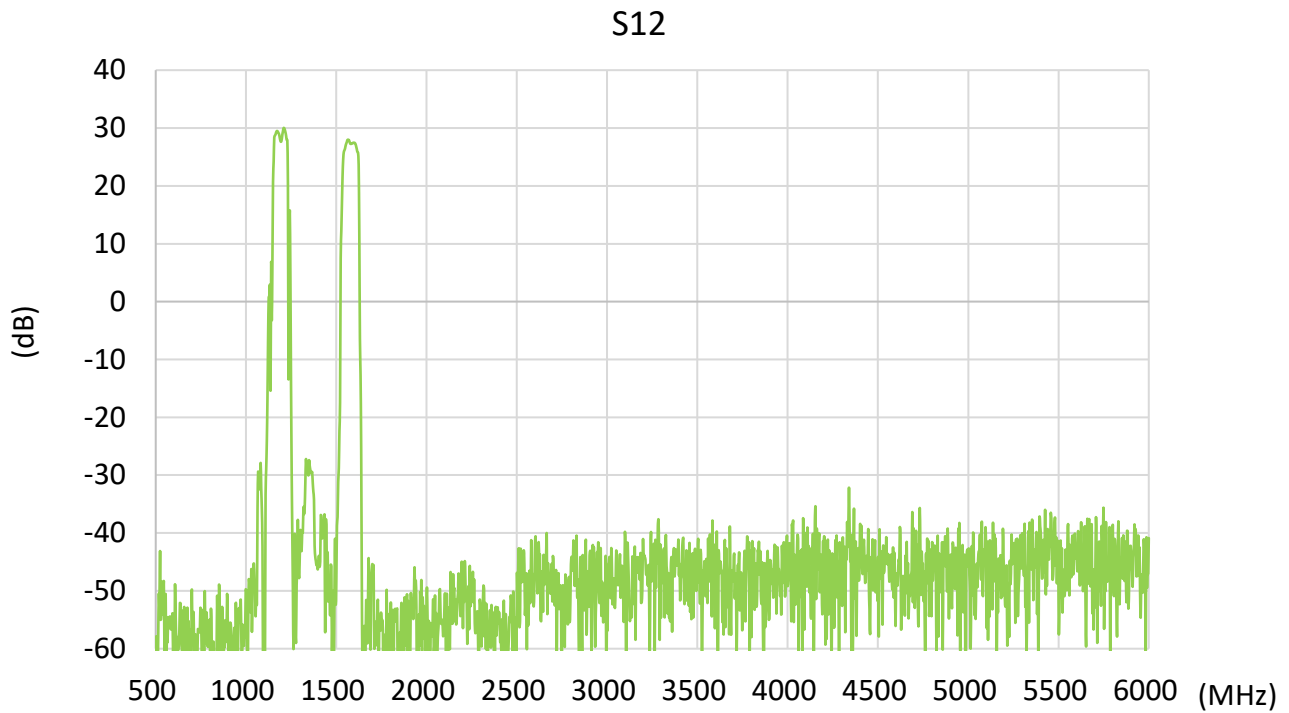

5.4 Noise Figure @3.0V

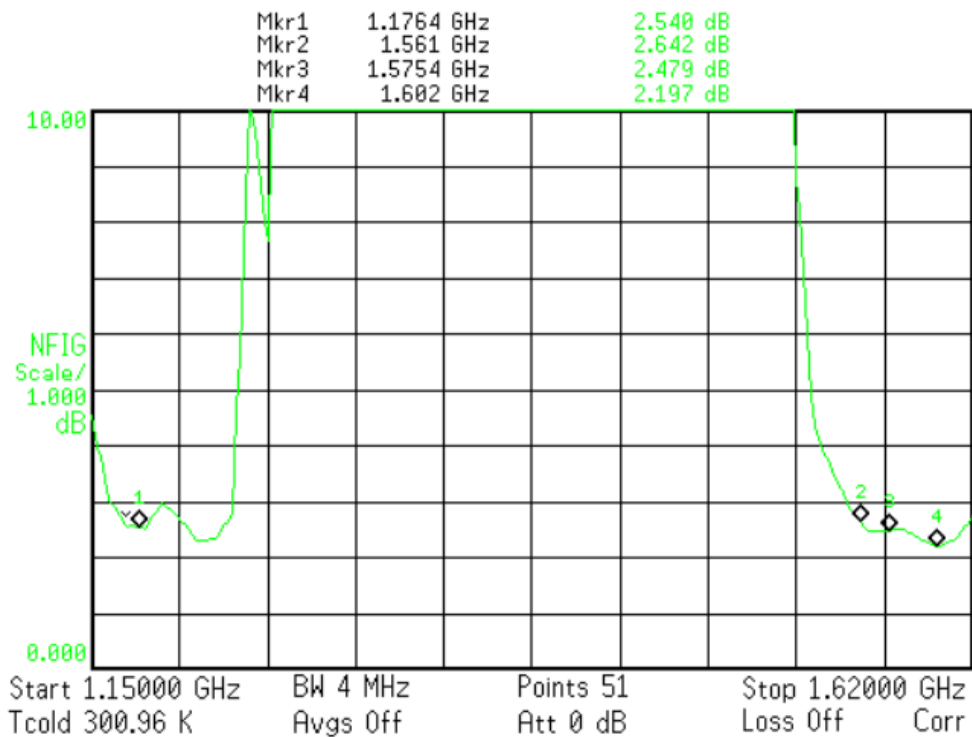

6. Field Test Results

6.1 Rooftop test

In this section Taoglas will present the field test result for A.85 antenna. The test was performed when the antenna was mounted on a static rooftop test set up in an open sky environment for at least 6 hours.

Receiver: Septentrio AsteRx-U S/N

Receiver Features:

- Multi-band GNSS: 544 channels
- GPS: L1, L2, L5 GLONASS: L1, L2, L3 Galileo: E1, E5ab, AltBoc, E6 BeiDou: B1, B2, B3 NavIC: L1, L2, L5, L6
- SBAS: EGNOS, WAAS, GAGAN, MSAS, SDCM(L1, L5)
- RTK (base and rover), Integrated dual-channel L-band receiver, Support for PPP
- Nav. update rate up to 100 Hz
- Position accuracy = RTK 0.6 cm + 0.5 ppm

Positioning Accuracy Table (2D Accuracy)				
Test Condition	Correction Service	CEP (50%)	DRMS (68%)	2DRMS (95-98.2%)
Free Space	RTK Disabled	61.8 cm	74.1 cm	148.1 cm
	RTK Enabled	0.7 cm	0.9 cm	1.8 cm
30x30 cm Ground Plane	RTK Disabled	35.5 cm	42.8 cm	85.5 cm
	RTK Enabled	1.6 cm	1.9 cm	3.8 cm

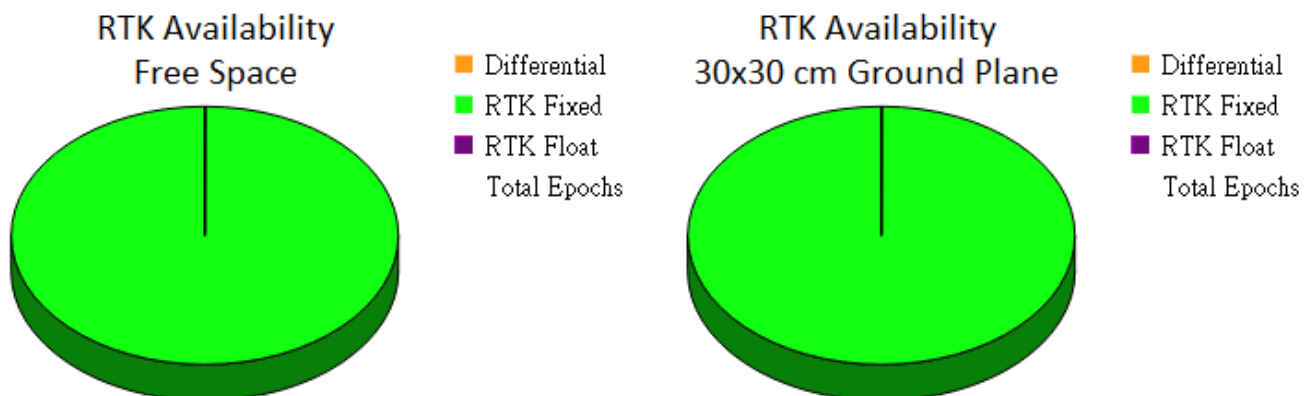

7. Mechanical Drawing (Units: mm)

Top View

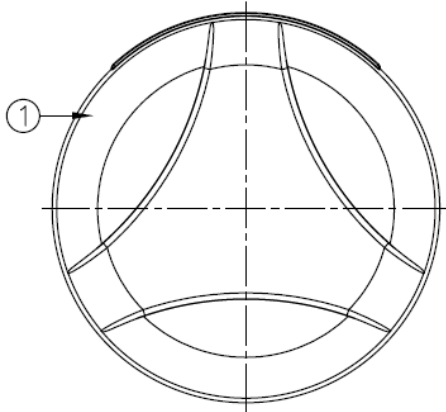

Bottom Thread View

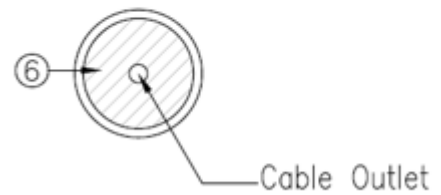

Front View

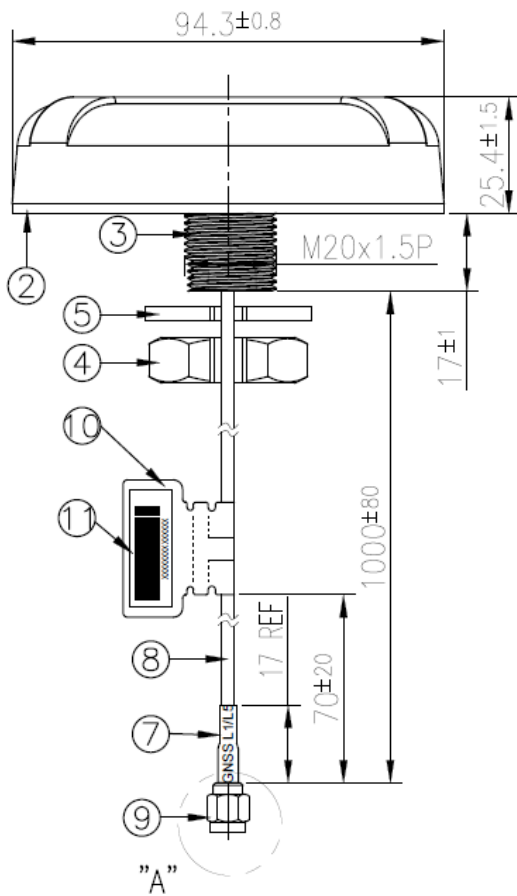

SMA(M)ST

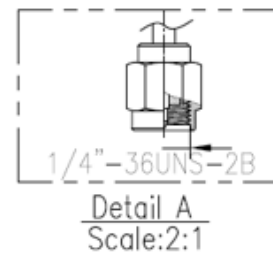

	Name	Material	Finish	QTY
1	Housing	ASA	Black	1
2	Double Sided Adhesive(Black Foam)	3M9448+CR4305	White Liner	1
3	Mini ST Base	Zinc Alloy	Ni Plated	1
4	Nut_M20x1.5Px9.5H Cut	Steel Carbon	Ni-Zn plated	1
5	Washer_Cut	Steel Carbon	Ni-Zn plated	1
6	Cable Rubber For RG-174	Silicone Rubber	Black	1
7	Heat Shrink Tube (GNSS L1/L5)	PE	Blue Tube /White Text	1
8	RG174 Coaxial Cable	PVC	Black	1
9	SMA(M)ST	Brass	Au Plated	1
10	Empty Label	PEPA	White	1
11	Barcode Label	PET	White	1

8. Packaging

8.1 Individual Packaging

A.85.A.101111 Per PE bag
 Bag Dimensions – 232*183mm
 Total Weight – 283.5g



1pcs/PE Bags Per Inner Carton
 Inner Carton Dimensions – 117*109*58mm
 Weight – 310g

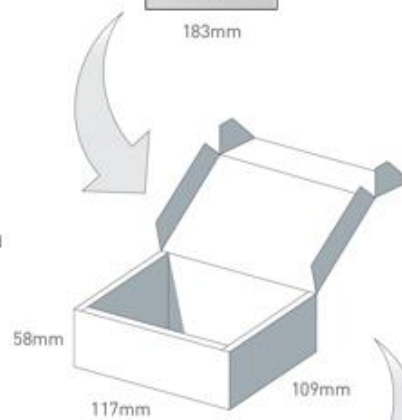

25 Inner Cartons Per Outer Carton
 Carton Dimensions – 589*296*135mm
 Weight – 8Kg

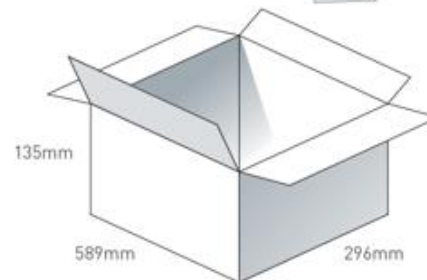

Pallet Dimensions 1200*1000*1420mm
 54 Cartons Per Pallet
 6 Cartons Per Layer
 9 Layers

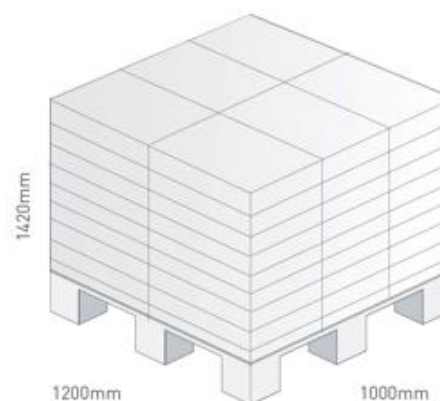

8.2 Bulk Packaging

A.85.A.101111 Per PE bag
 Bag Dimensions – 232*183mm
 Total Weight – 283.5g

50 Pc Per Carton In Bulk Packaging
 Carton Dimensions – 600*340*245mm
 Weight – 13Kg

Pallet Dimensions 1200*1000*1420mm
 20 Cartons Per Pallet
 4 Cartons Per Layer
 5 Layers

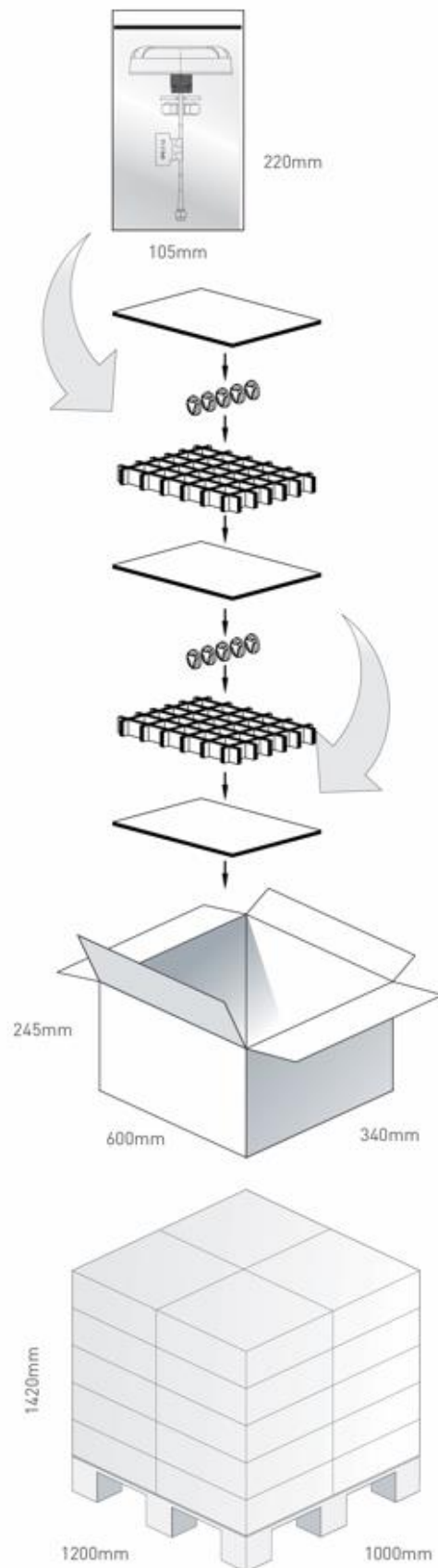

Changelog for the datasheet

SPE-22-8-112 – A.85.A.101111

Revision: C (Current Version)	
Date:	2025-01-06
Changes:	Updated GNSS Bands Frequency Table.
Changes Made by:	Gary West

Previous Revisions

Revision: B	
Date:	2022-02-22
Changes:	Updated GNSS Bands & Constellations Graphics
Changes Made by:	Cesar Sousa

Revision: A (Original First Release)	
Date:	2022-07-19
Notes:	Initial Datasheet Release
Author:	Gary West

--	--

--	--

--	--

--	--

--	--

--	--

--	--

--	--



TAOGLAS®

www.taoglas.com

