

SPECIFICATION

Part No.	:	DXP.02.A
Product Name	:	SMD L1/L2/L5 SAW Diplexer For GNSS Band Applications
Features	:	L5 1176.45 / L2 1222.7625 / L1 1575.42 MHz SAW Diplexer SMT Direct Mount Compact Size 5*5*1.7mm Low Insertion Loss In band High Isolation Port to Port RoHS Compliant

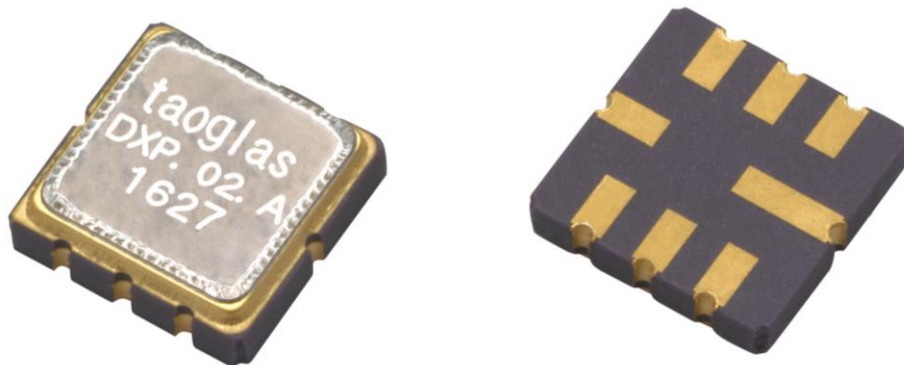

1. Introduction

The Taoglas DXP.02.A is a compact SAW diplexer for use in any navigation system application using the GPS/GALILEO L1, L2 & L5 bands.

The diplexer is designed to function as both a bandpass filter for each band and to either split one path into three or to combine the bands back into one RF feed. For example, a customer who wanted to use passive antenna elements would need to implement a diplexer in some cases to split the bands out into separate paths. It is also designed to isolate and reject any unwanted GPS signals from getting to the application port.

It is housed in a compact 5*5*1.7mm over-molded laminate package and is easy to integrate using SMT process mounting directly onto the target PCB.

Contact your regional Taoglas sales office for more information or support.

2. Specification

Band 1 (L1)			
	Min.	Typ.	Max.
Center Frequency (MHz)	-	1582.1875	-
Insertion Loss (dB)	-	3.8	4.6
Amplitude Ripple (dB)	-	0.6	2.0
Return Loss (dB)	-	-13	-6.0
Attenuation (Reference level from 0dB)			
10 ~ 1330 (MHz)	32	38	-
1660 ~ 2000 (MHz)	27	33	-
Band 2 (L2 and L5)			
	Min.	Typ.	Max.
Center frequency (MHz)	-	1206.9225	-
Insertion Loss (dB)	-	4.2	5.2
Amplitude Ripple (dB)	-	1.2	2.5
Return Loss (dB)	-	-8	-6
Attenuation (Reference level from 0dB)			
10 ~ 1100 (MHz)	17	23	-
1320 ~ 2000 (MHz)	20	28	-
Band 1 and Band 2			
	Min.	Typ.	Max.
Isolation (1196.9~1248.625MHz)	22	35	-
Isolation (1574.22~1576.62 dB)	22	31	-
Environmental			
Operating Temperature	-40°C to 85°C		
Storage Temperature	-40°C to 85°C		
Input power Level	10 dBm		
DC Voltage	3 V		

3. Measurement Circuit

HP Network analyzer

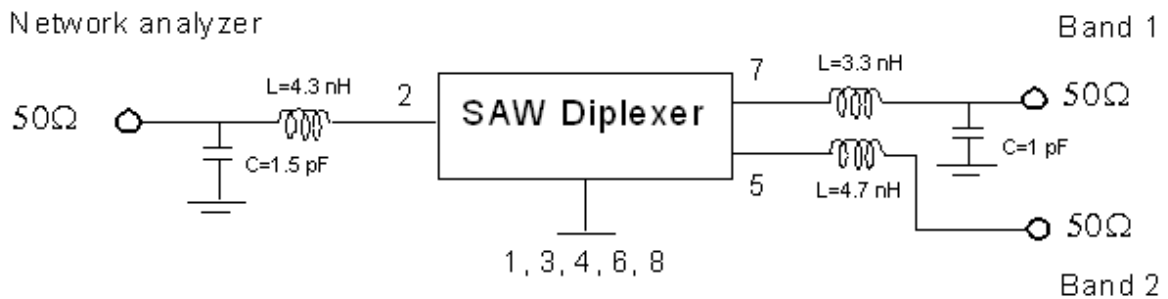

3.1 Test setup

Band 1 (L1) Band 2(L2/L5)



Common Port

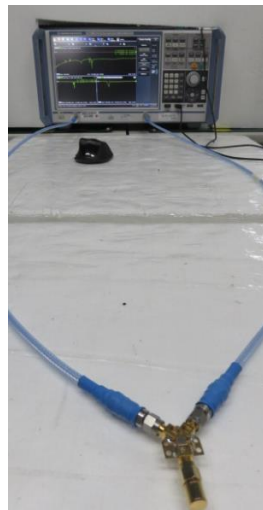

3.2 Return Loss

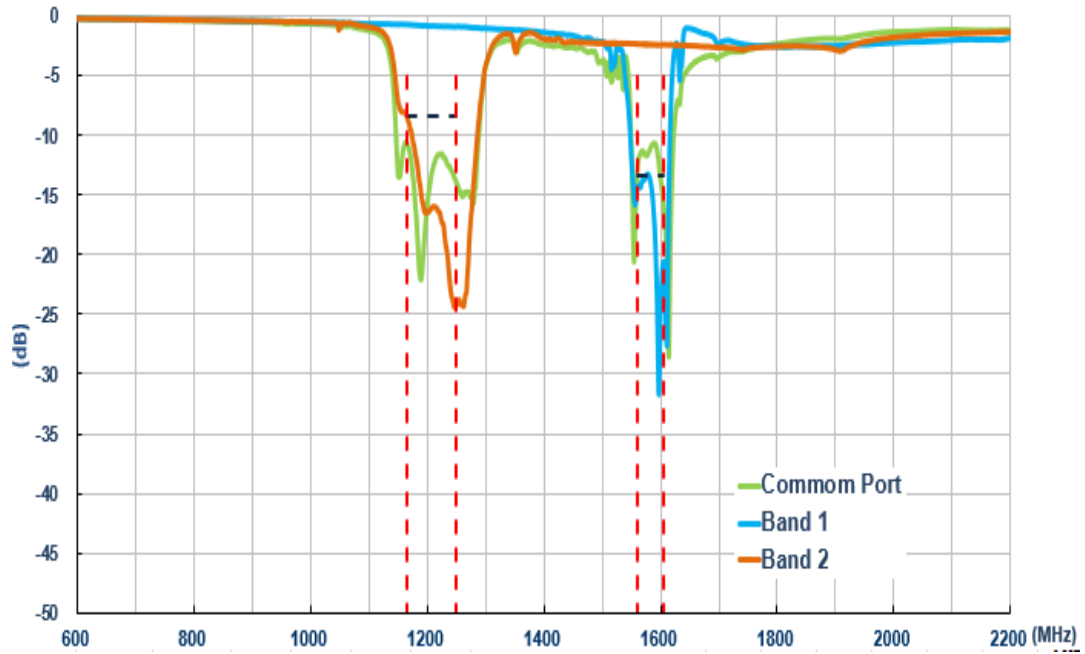

Return Loss (dB)	
Band 1 1559~1605.375MHz	Band 2 1165.22~1248.625MHz
<-13.4	<-8.4

3.3 Common Port to Band 1 Port _ 1582.1875MHz Attenuation

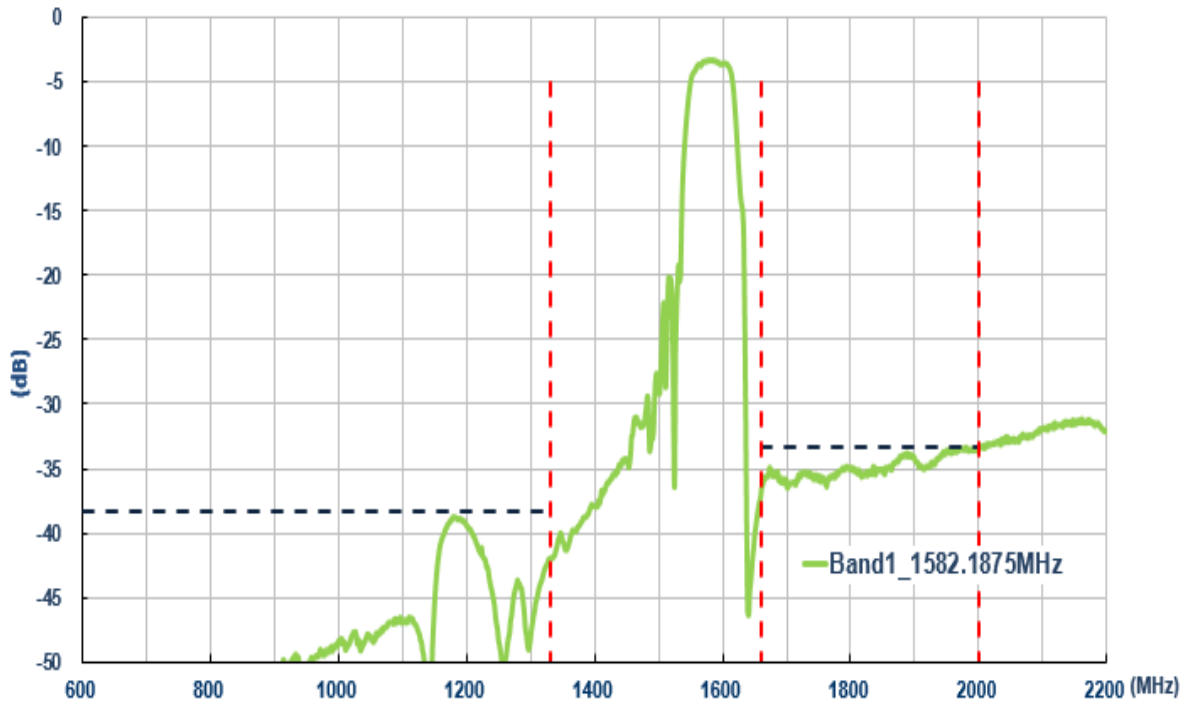

Attenuation (dB)	
10~1330MHz	1660~2000MHz
<-38.4	<-33.4

3.4 Common Port to Band 1 Port _ 1582.1875MHz Insertion Loss

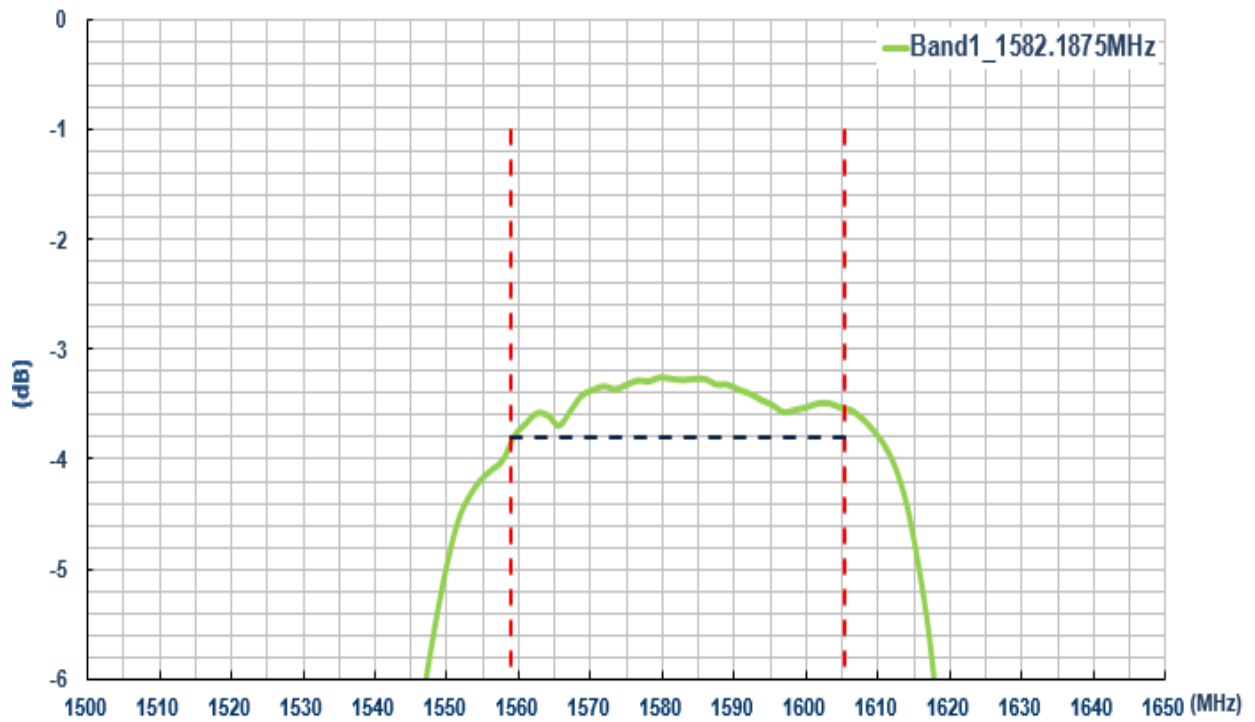

Insertion Loss(dB)
1559~1605.375MHz
< -3.8

3.4 Common Port to Band 1 Port _1206.9225MHz Attenuation

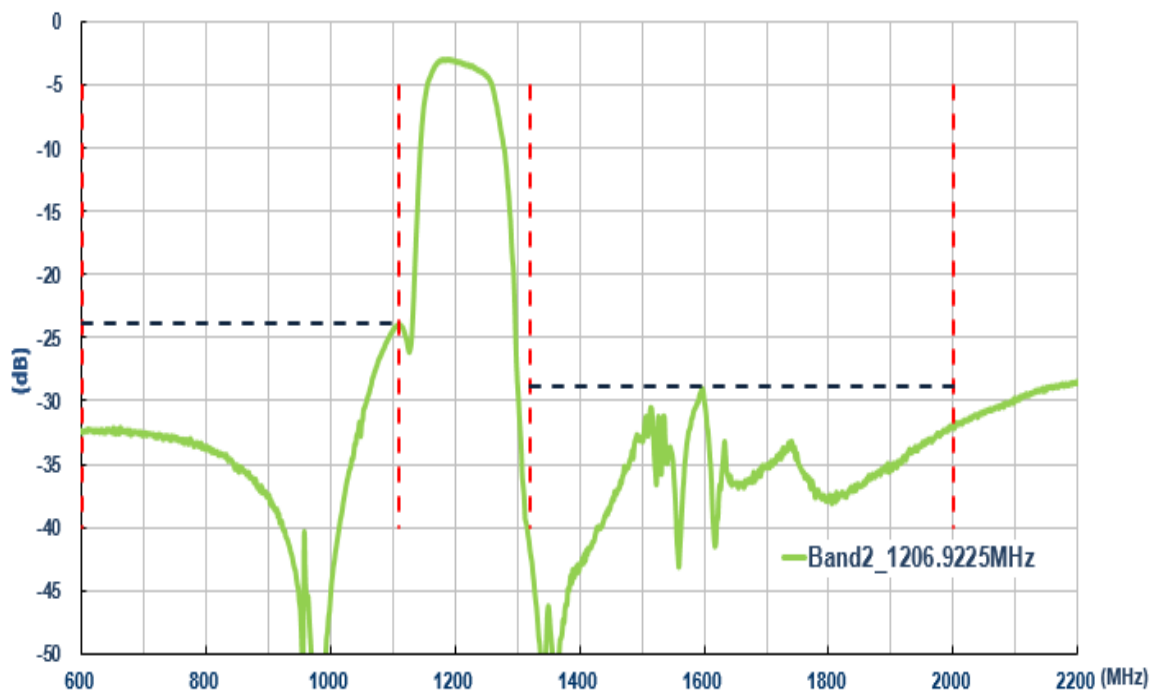

Attenuation (dB)	
10~1110MHz	1320~2000MHz
<-23.9	<-28.9

3.5 Common Port to Band 2 Port _ 1206.9225MHz Insertion Loss

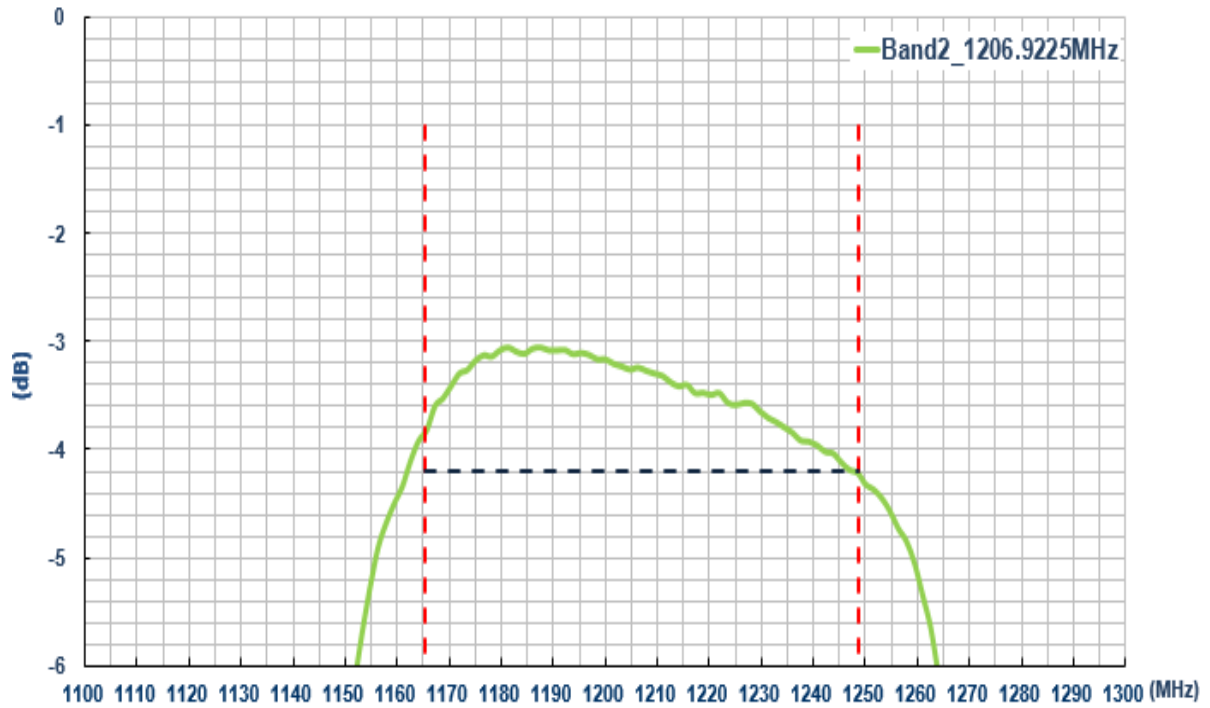

Insertion Loss(dB)
1165.22~1248.625MHz
> -4.2

3.6 Band1Port – Band 2 Port Isolation

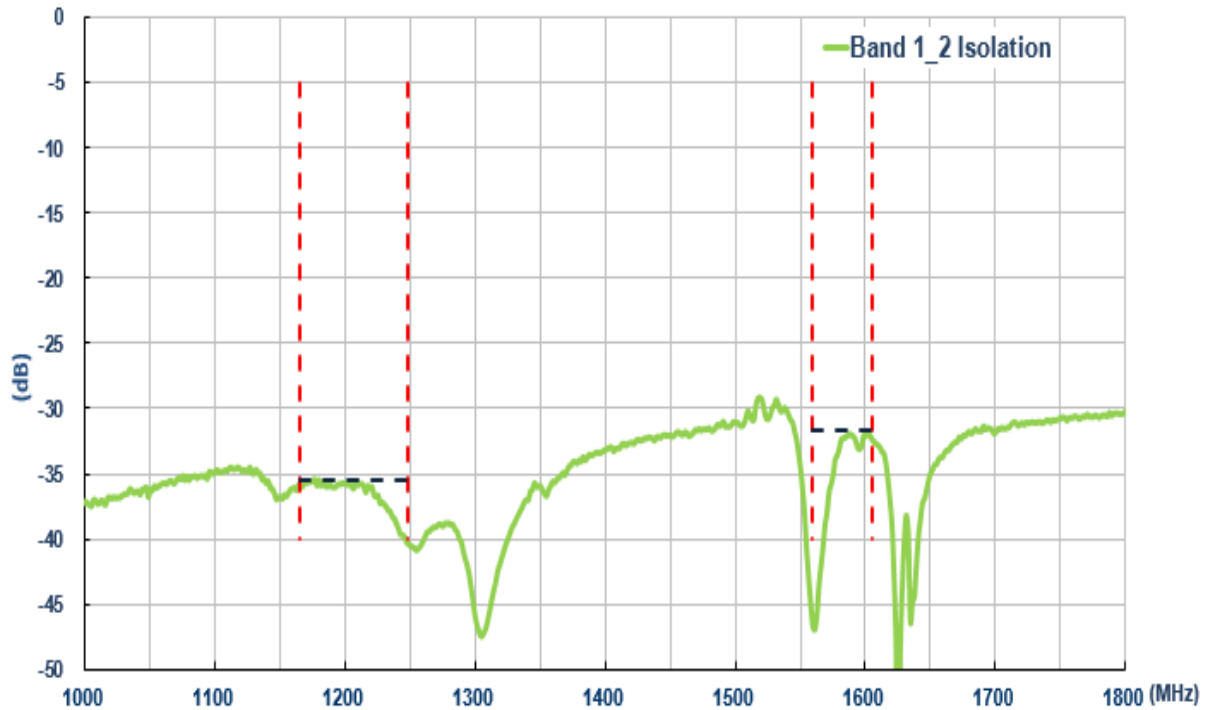

Isolation (dB)	
Band 1 1165.22~1248.625 MHz	Band 2 1559~1605.375MHz
<-35.5	-31.6

4. Drawing (Unit: mm)

4.1 Diplexer Drawing

Front View

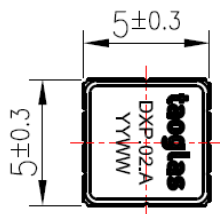

Side View

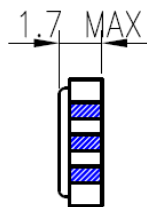

Back View

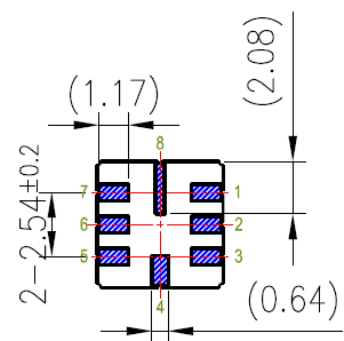

4.2 Foot Print

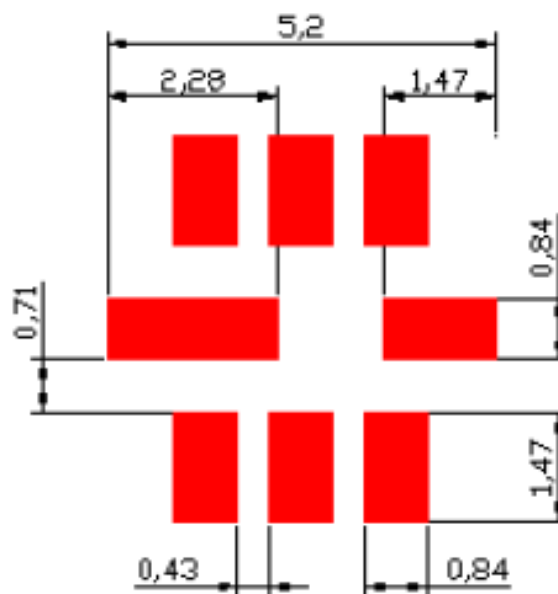

5. Recommended Reflow Profile

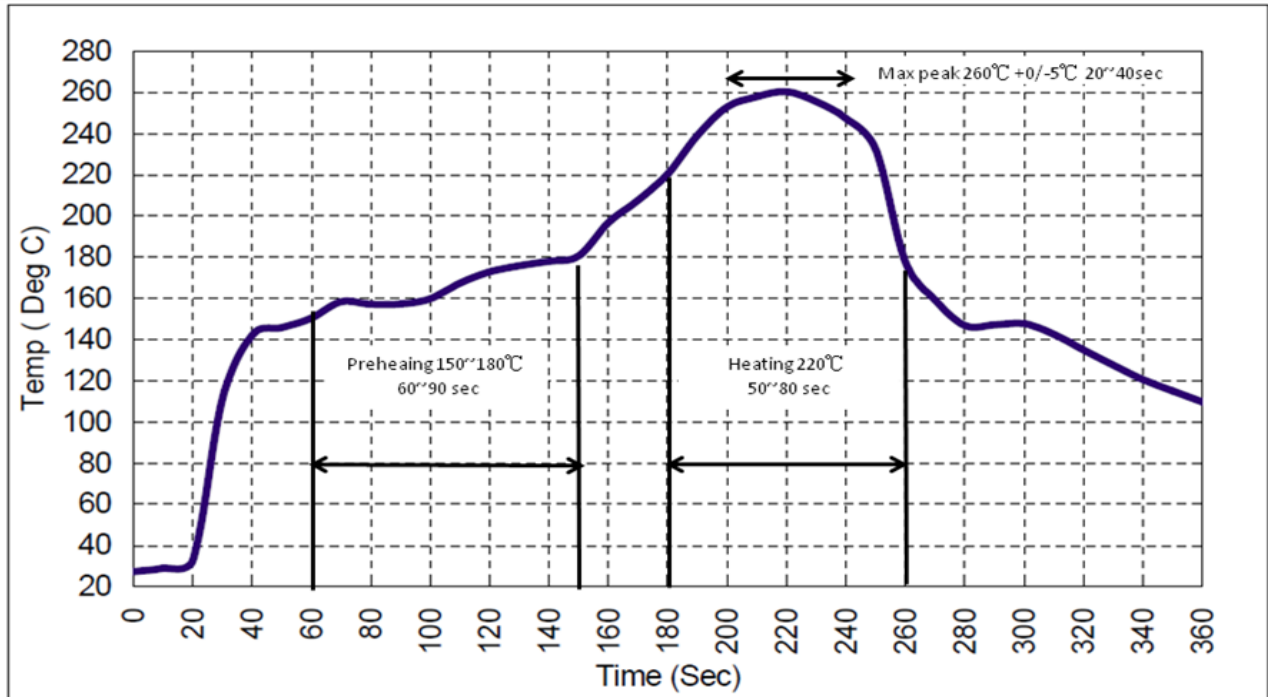

1. Preheating shall be fixed at 150~180°C for 60~90 seconds.
2. Ascending time to preheating temperature 150°C shall be 30 seconds minimum.
3. Heating shall be fixed at 220°C for 50~80 seconds and 260°C as the peak for 20-40 seconds.
4. Time: 2 times.

6. Packaging

Tape Dimension

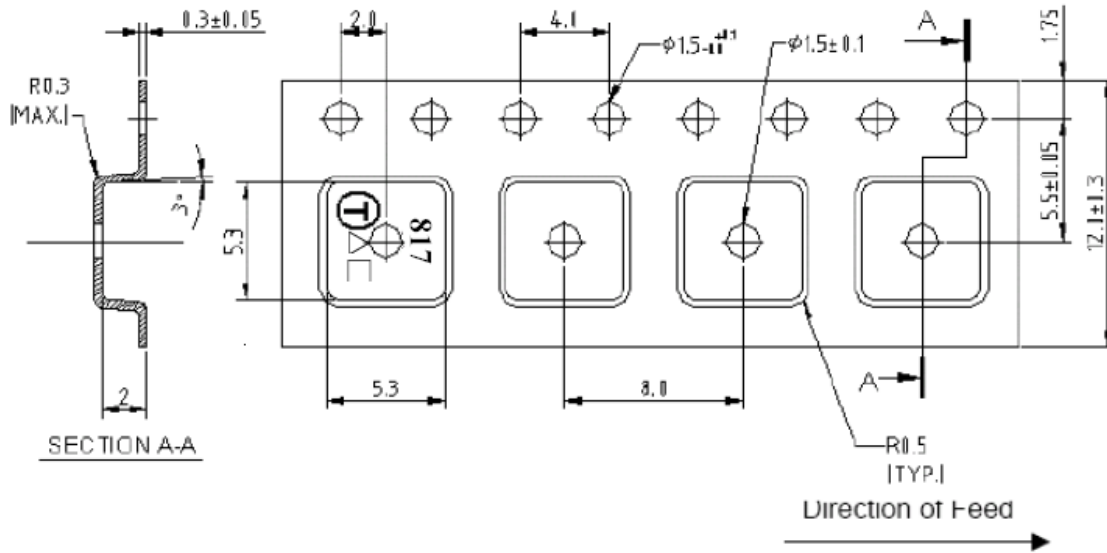

Reel Dimension

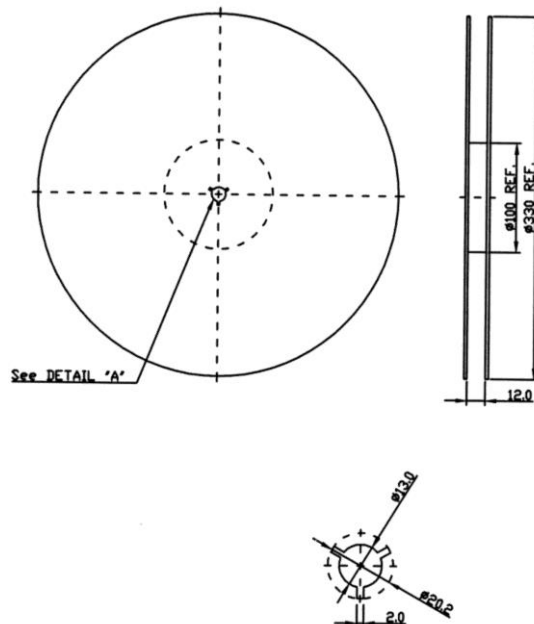

Packaging Detail

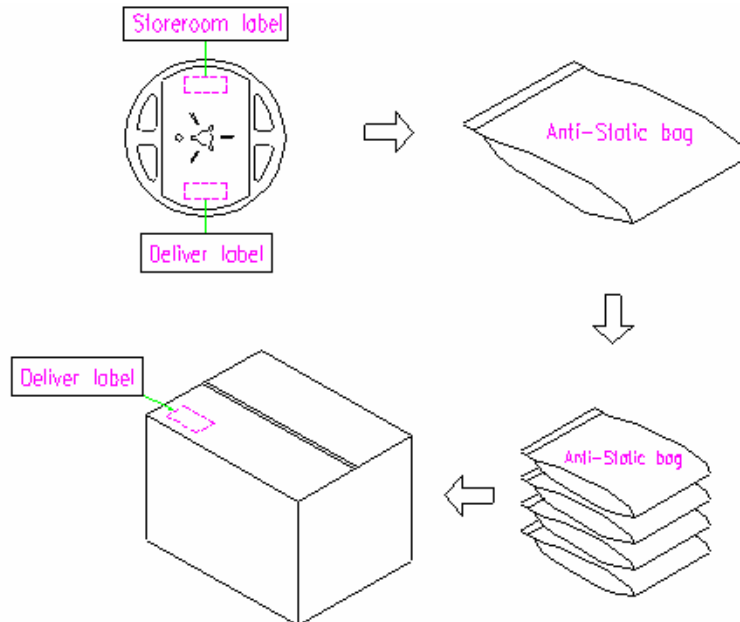

1k pieces per reel, 4 reels per carton.

Taoglas makes no warranties based on the accuracy or completeness of the contents of this document and reserves the right to make changes to specifications and product descriptions at any time. Taoglas reserves all rights to this document and the information contained herein.

Reproduction, use or disclosure to third parties without express permission is strictly prohibited.

Copyright © Taoglas