



# Datasheet

## Minima

**Part No:**  
FXUB68.07.0180C

### Description:

Minima Embedded Flexible 4G LTE Wide Band  
Antenna 700-960MHz, 1700-2700MHz

### Features:

- Flexible Wideband Antenna
- Covers worldwide 4G/3G/2G Bands
- Isotropic Radiation Pattern
- Highest efficiency in smallest size
- 67.0x58.0x0.2 mm
- I-PEX® I1.37 coaxial cable
- CE Certified
- RoHS Compliant

1. Introduction	3
2. Specifications	4
3. Antenna Characteristics	6
4. Radiation Patterns	9
5. Mechanical Drawing	19
6. Packaging	20
7. Application Note	21
<hr/>	
Changelog	23

Taoglas makes no warranties based on the accuracy or completeness of the contents of this document and reserves the right to make changes to specifications and product descriptions at any time without notice. Taoglas reserves all rights to this document and the information contained herein. Reproduction, use or disclosure to third parties without express permission is strictly prohibited.



# 1. Introduction



The patent pending Minima FXUB68 flexible antenna has been designed to cover 4G bands in the 700-2700MHz spectrum, but also optimally covers 3G and 2G. The antenna has a compact, flexible, modern design, with excellent efficiencies on all target bands.

The Minima comes standard with 180mm IPEX cable and connector for easy installation and can also be configured for different cable lengths and terminations. The 67x58x0.2mm FXUB68 is made from flexible polymer material, which is ultra-thin, compact and highly efficient across the 4G and 3G bands. It is installed by a simple “peel and stick” process, attaching securely to non-metal surfaces via adhesive backing.

The Minima has been designed with excess bandwidth so that performance is not affected by thicker or thinner plastic surfaces to which it is adhered. It enables designers to use only one antenna that covers all cellular communication frequencies in the IoT market.

The Minima antenna has a unique compact geometric design, which has excellent efficiency for its size and isotropic pattern at both low and high bands. This antenna if integrated optimally with enough clearance, can in most cases pass US operator requirements.

The antenna performs well at a reasonable distance, typically 20mm, from a ground and has demonstrated ease of integration into complex end user equipment.

The FXUB65 Minima antenna has a typical efficiency of more than 50% across the low bands and 64% across the high bands. The Minima is designed to be mounted directly onto a plastic or glass cover. It is an ideal choice for any device maker that desires ease of integration and needs to keep manufacturing costs down over the lifetime of a product.

Cable and connector can be customized, contact your regional Taoglas customer support team for more information.

## 2. Specifications

### 5G/4G Bands

Band Number	5G NR / FR1 / LTE / LTE-Advanced / WCDMA / HSPA / HSPA+ / TD-SCDMA		
	Uplink	Downlink	Covered
1	UL: 1920 to 1980	DL: 2110 to 2170	✓
2	UL: 1850 to 1910	DL: 1930 to 1990	✓
3	UL: 1710 to 1785	DL: 1805 to 1880	✓
4	UL: 1710 to 1755	DL: 2110 to 2155	✓
5	UL: 824 to 849	DL: 869 to 894	✓
7	UL: 2500 to 2570	DL: 2620 to 2690	✓
8	UL: 880 to 915	DL: 925 to 960	✓
9	UL: 1749.9 to 1784.9	DL: 1844.9 to 1879.9	✓
11	UL: 1427.9 to 1447.9	DL: 1475.9 to 1495.9	✓
12	UL: 699 to 716	DL: 729 to 746	✓
13	UL: 777 to 787	DL: 746 to 756	✓
14	UL: 788 to 798	DL: 758 to 768	✓
17	UL: 704 to 716	DL: 734 to 746	✓
18	UL: 815 to 830	DL: 860 to 875	✓
19	UL: 830 to 845	DL: 875 to 890	✓
20	UL: 832 to 862	DL: 791 to 821	✓
21	UL: 1447.9 to 1462.9	DL: 1495.9 to 1510.9	✓
22	UL: 3410 to 3490	DL: 3510 to 3590	✗
23	UL: 2000 to 2020	DL: 2180 to 2200	✓
24	UL: 1625.5 to 1660.5	DL: 1525 to 1559	✓
25	UL: 1850 to 1915	DL: 1930 to 1995	✓
26	UL: 814 to 849	DL: 859 to 894	✓
27	UL: 807 to 824	DL: 852 to 869	✓
28	UL: 703 to 748	DL: 758 to 803	✓
29	UL: -	DL: 717 to 728	✓
30	UL: 2305 to 2315	DL: 2350 to 2360	✓
31	UL: 452.5 to 457.5	DL: 462.5 to 467.5	✗
32	UL: -	DL: 1452 - 1496	✓
35		1850 to 1910	✓
38		2570 to 2620	✓
39		1880 to 1920	✓
40		2300 to 2400	✓
41		2496 to 2690	✓
42		3400 to 3600	✗
43		3600 to 3800	✗
48		3550 to 3700	✗
66	UL: 1710-1780	DL: 2110-2200	✓
71		617 to 698	✓
74/75/76		1427 to 1518	✓
78		3300 to 3800	✗
79		4400 to 5000	✗
85	698-716	728-746	✓

Electrical								
Frequency (MHz)	LTE 700	GSM 850	GSM 900	DCS	PCS	UMTS1	Wi-Fi	LTE 2600
	698~ 803	824~ 894	880~ 960	1710 ~1880	1850 ~1990	1920 ~2170	2400 ~2480	2490 ~2690
Max Return Loss (dB)	-9	-8	-7	-9	-17	-13	-13	-12
Max VSWR	2.5	2.5	3	2.5	1.5	1.5	1.5	2
Efficiency (%)	45	45	45	60	65	65	65	55
Peak Gain (dBi)	2	2	2	2	2.5	2.5	3	2
Average Gain (dB)	-3.5	-3.5	-3.5	-2.2	-2	-2	-2	-2.6
Radiation Properties	Omni-directional							
Max Input Power (Watts)	5							
Polarization	Linear							
Impedance (Ohms)	50 Ohms							
Mechanical								
Dimensions (mm)	67x58x0.2 mm							
Material	Flexible Polymer							
Connector	IPEX MHFI							
Cable	180mm 1.37							
Environmental								
Operation Temperature	-40°C to 85°C							
Storage Temperature	-40°C to 85°C							
Relative Humidity	40% to 95%							
RoHS Compliant	Yes							

### 3. Antenna Characteristics

#### 3.1 Return Loss

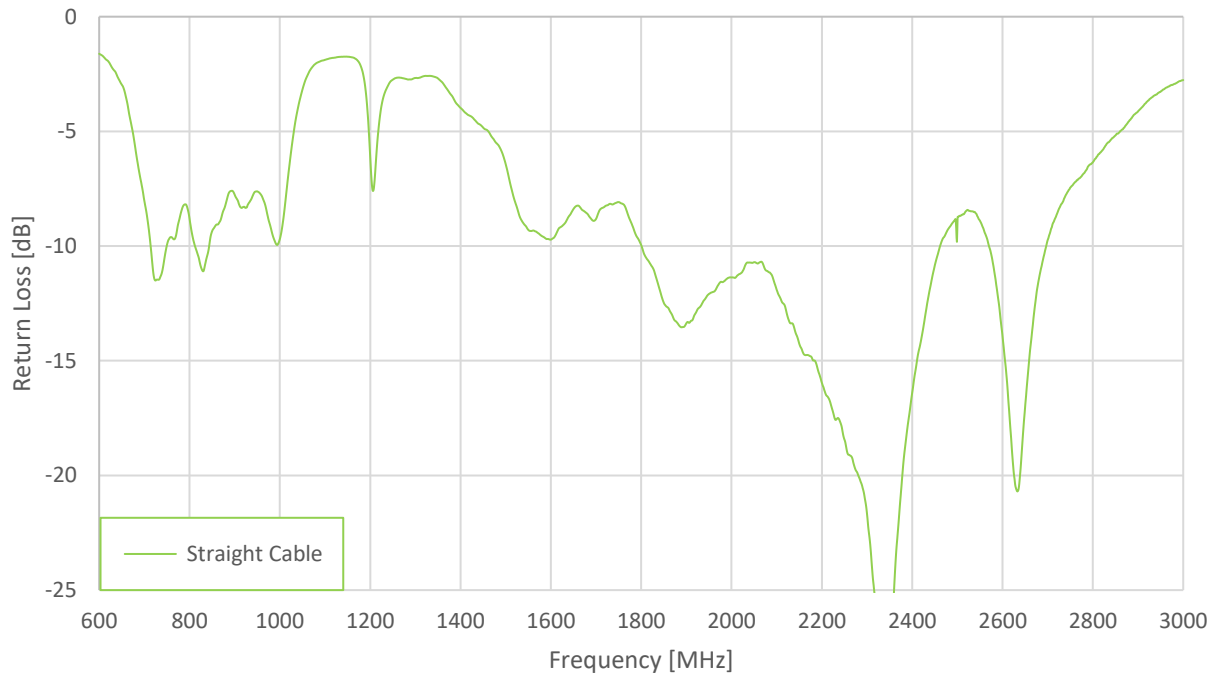

#### 3.2 Efficiency

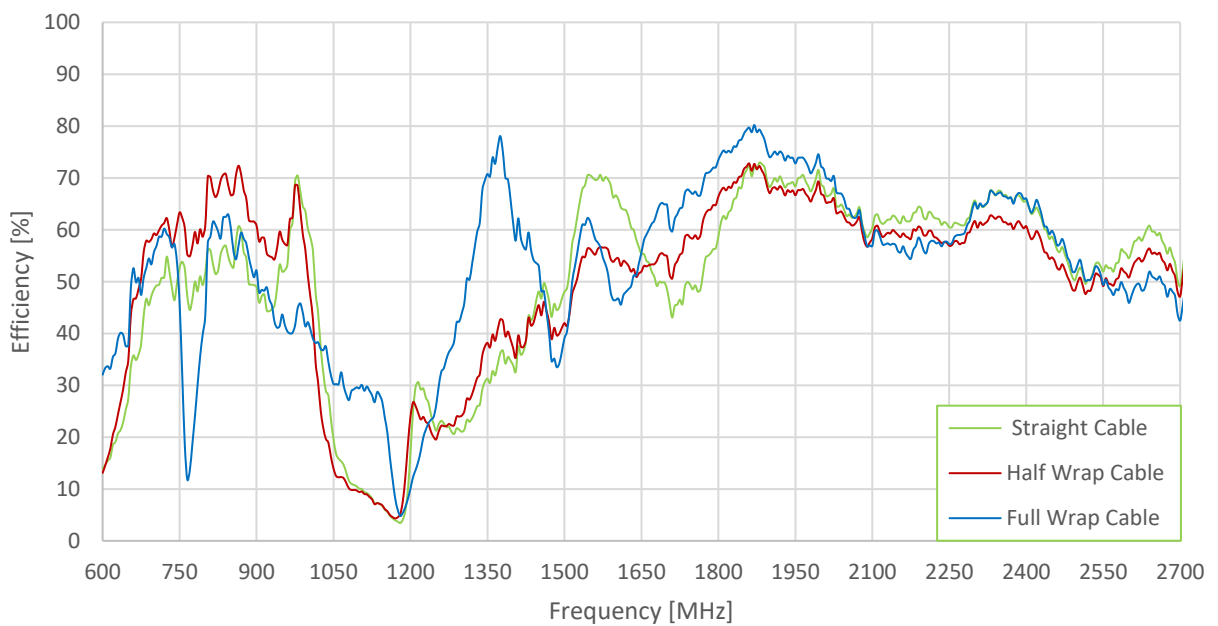

### 3.3 Average Gain

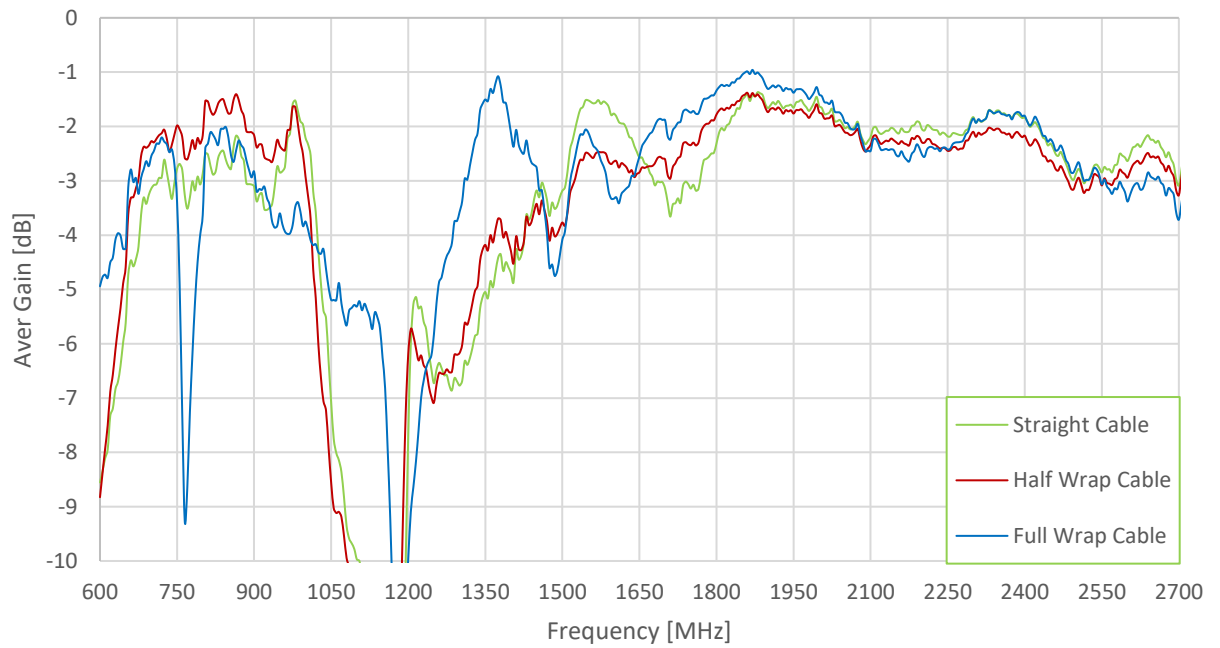

### 3.4 Peak Gain

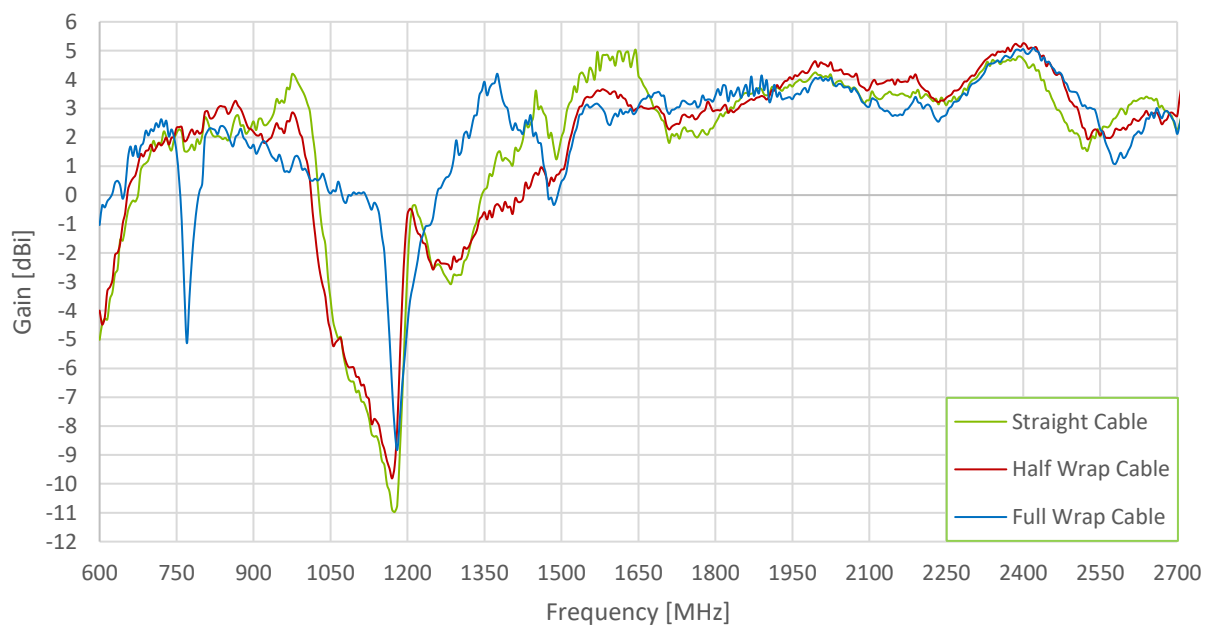

3.5 VSWR

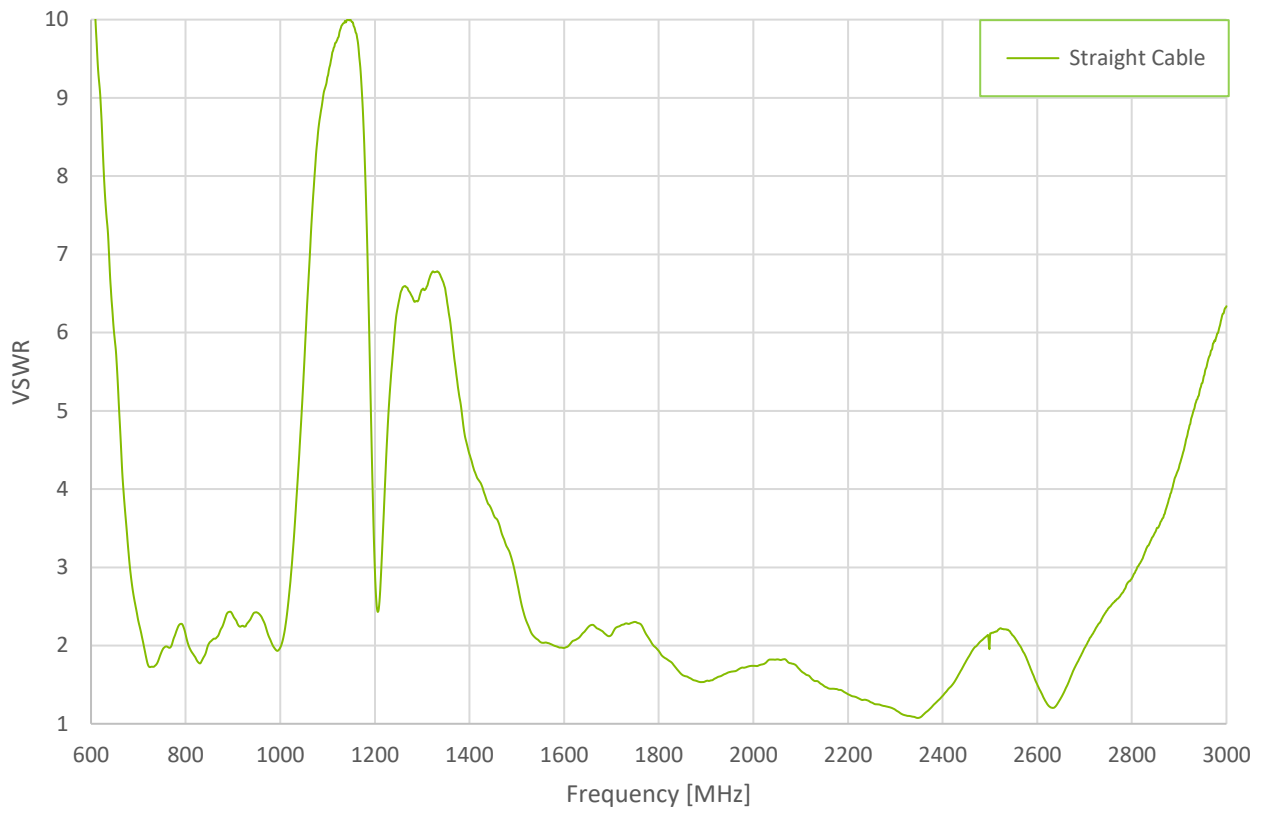



## 4. Radiation Patterns

### 4.1 Test Set-Up



Chamber Set-Up

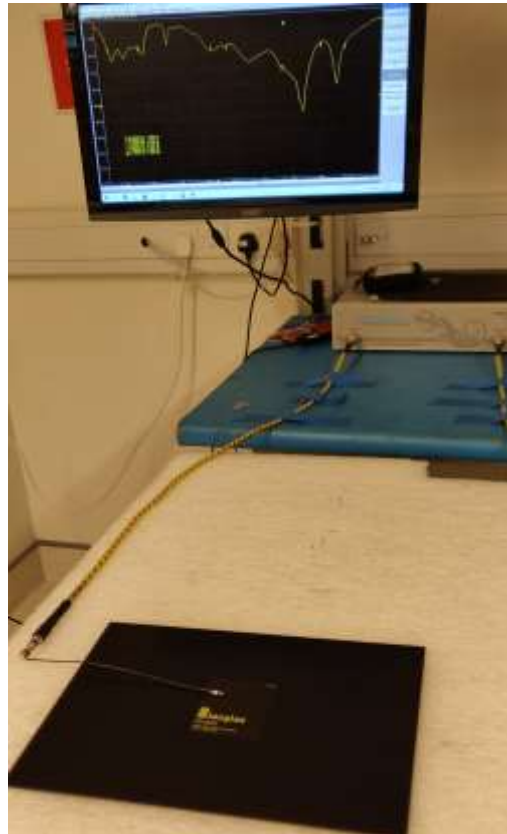

VNA Set-Up

4.2 2D And 3D Radiation Patterns

700 MHz

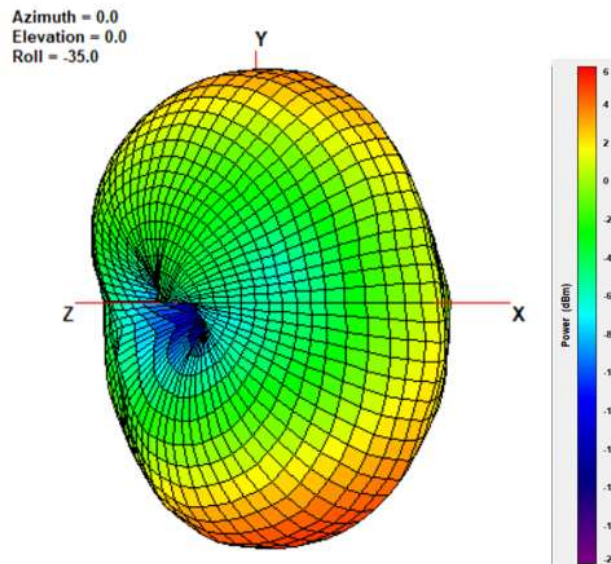

XY Plane

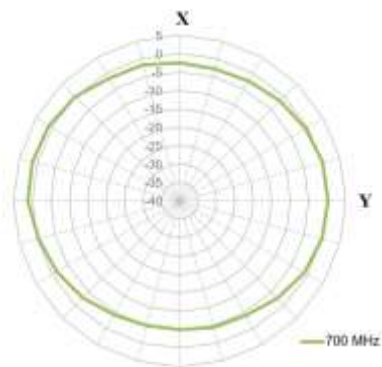

XZ Plane

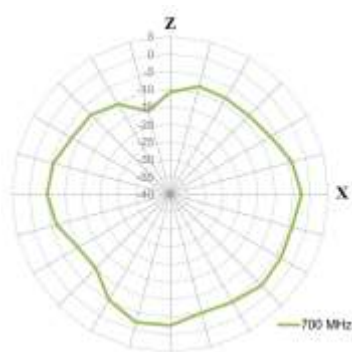

YZ Plane

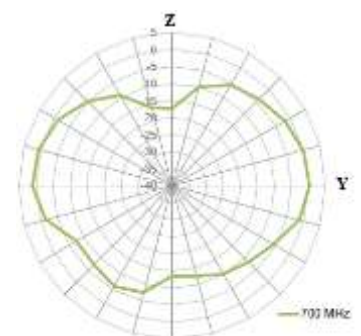

850 MHz

Azimuth = 0.0  
Elevation = 0.0  
Roll = -35.0

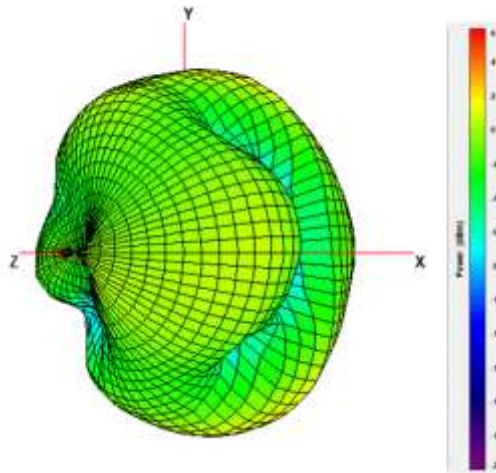

XY Plane

XZ Plane

YZ Plane

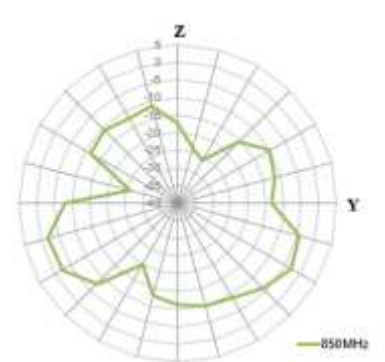
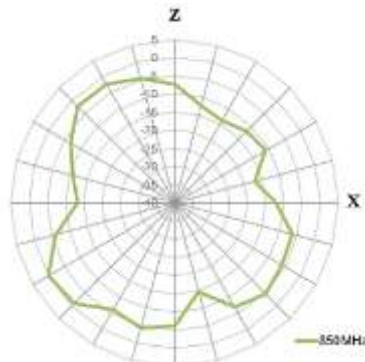
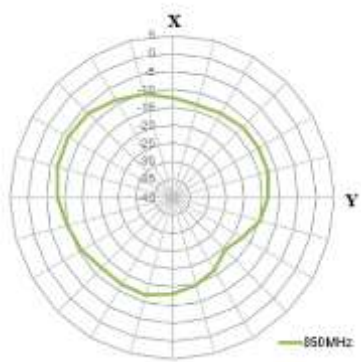

950 MHz

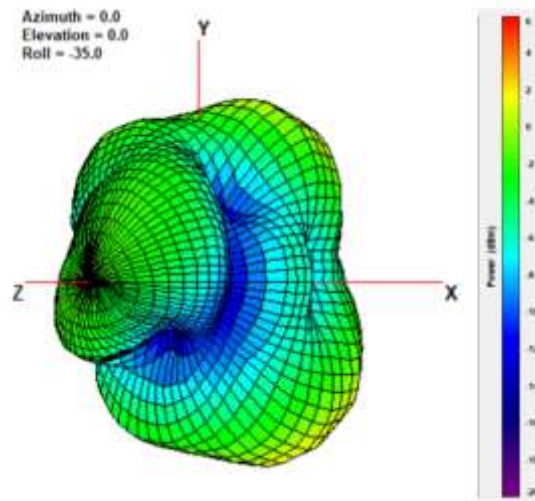

XY Plane

XZ Plane

YZ Plane

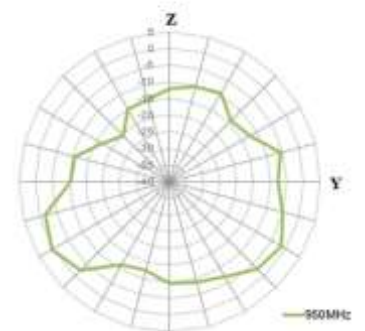
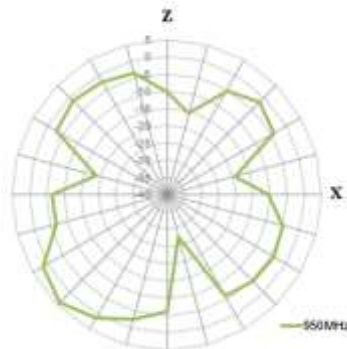
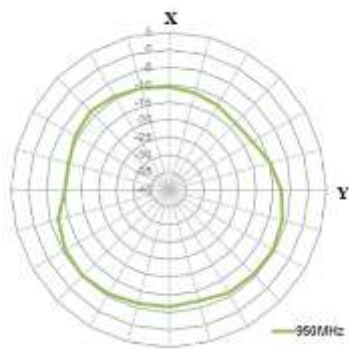

1750 MHz

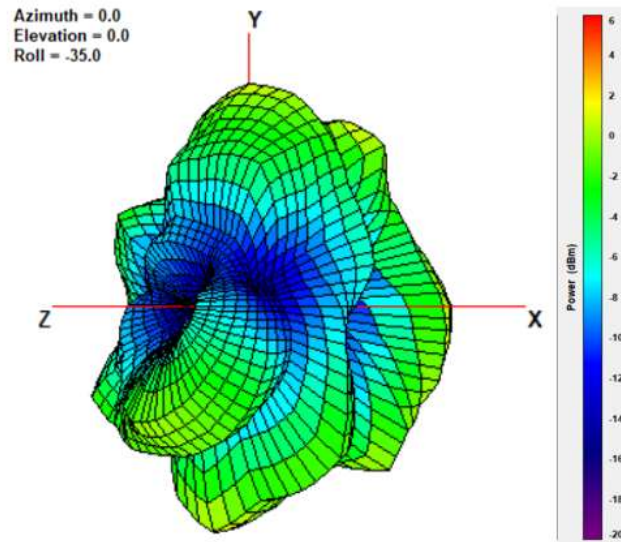

XY Plane

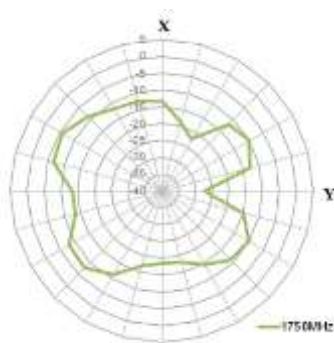

XZ Plane

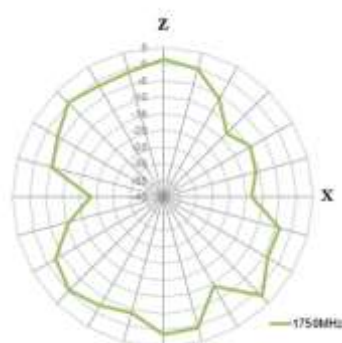

YZ Plane

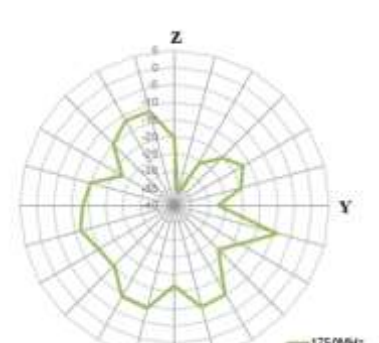

1850 MHz

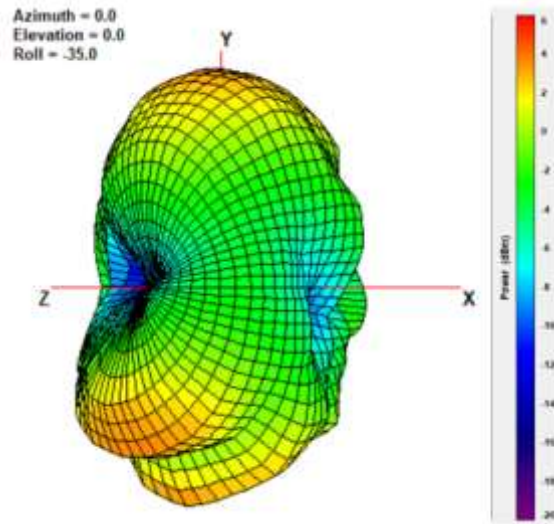

XY Plane

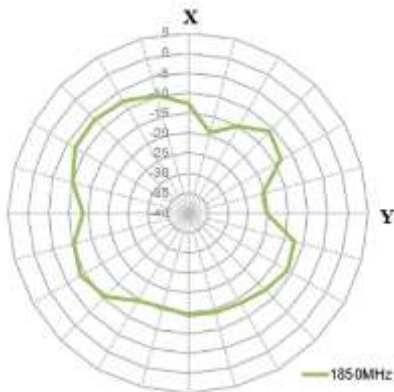

XZ Plane

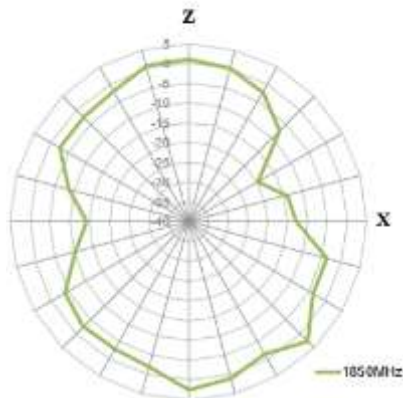

YZ Plane

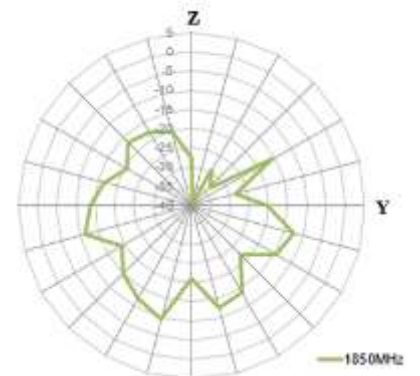

2000 MHz

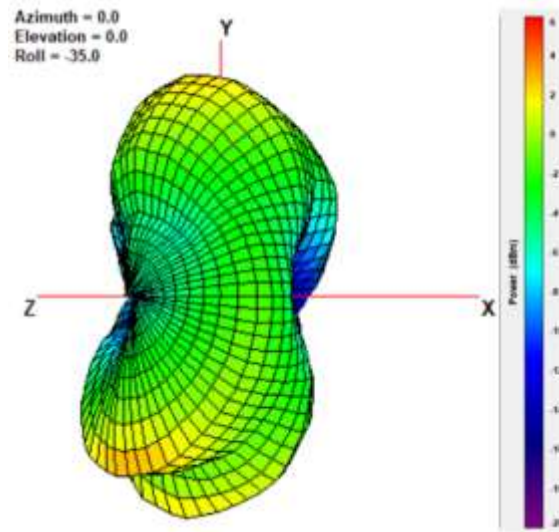

XY Plane

XZ Plane

YZ Plane

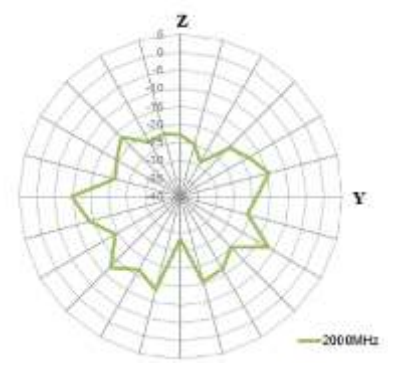
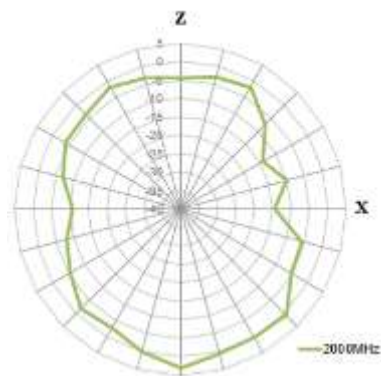
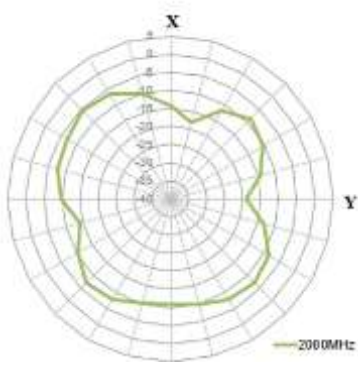

2150 MHz

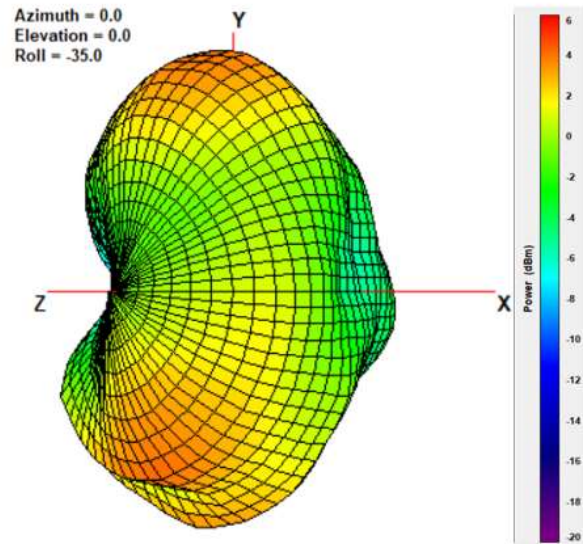

XY Plane

XZ Plane

YZ Plane

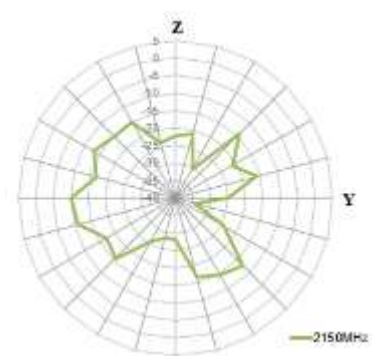
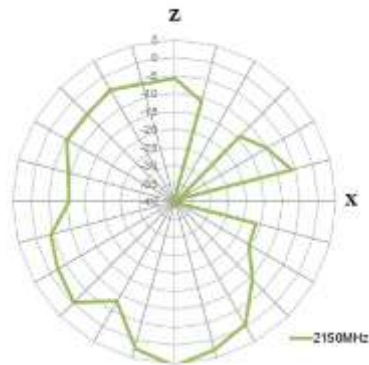
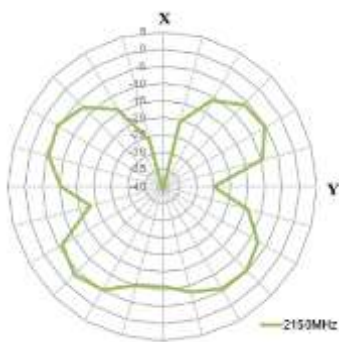



2600 MHz

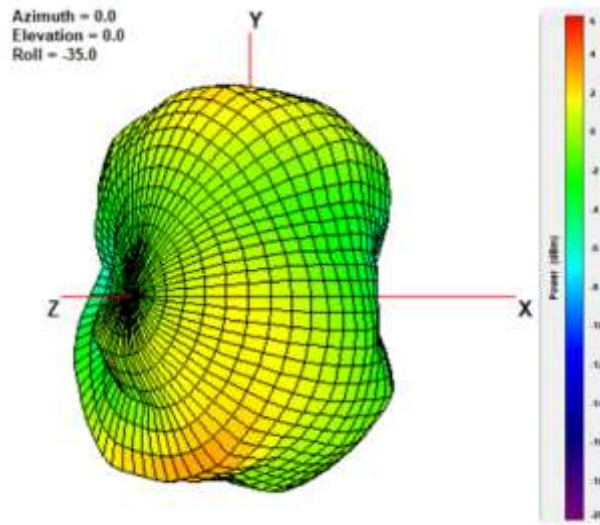

XY Plane

XZ Plane

YZ Plane

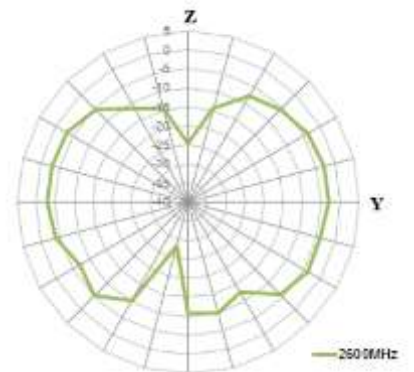
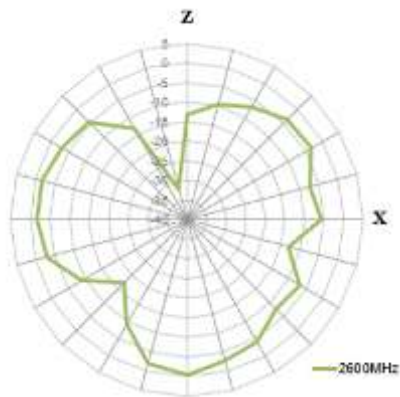
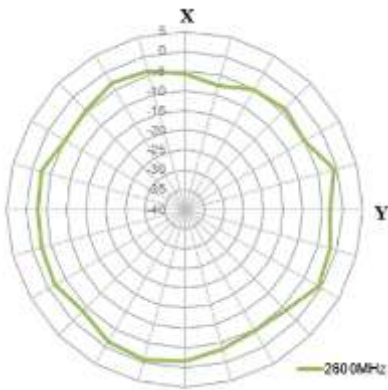

2750 MHz

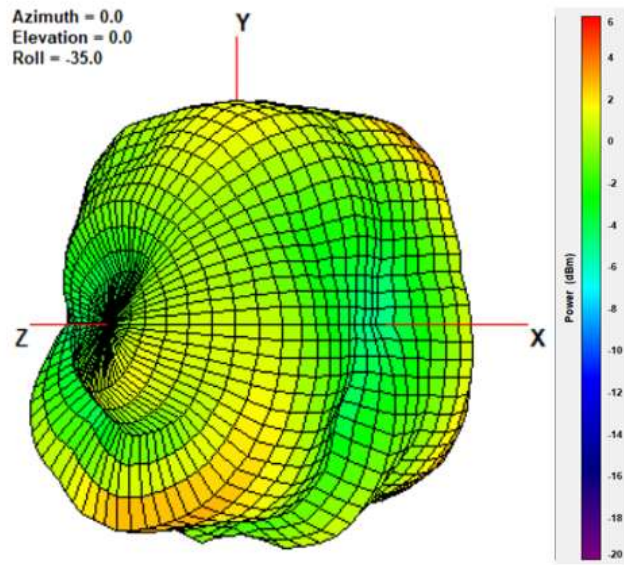

XY Plane

XZ Plane

YZ Plane

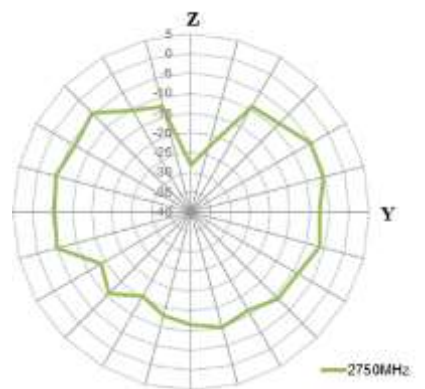
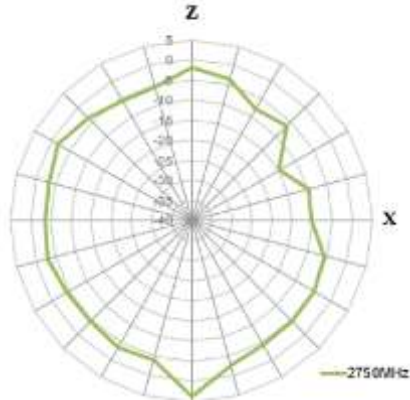
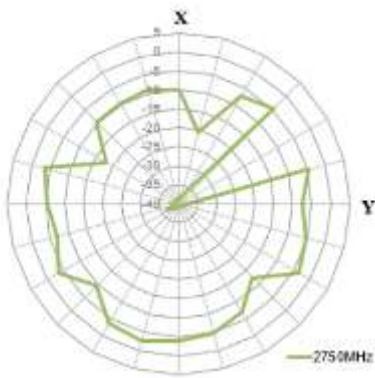

## 5. Mechanical Drawing (Units: mm)

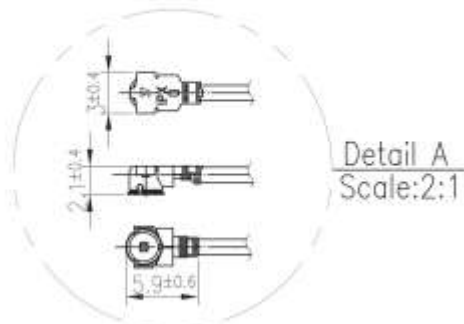
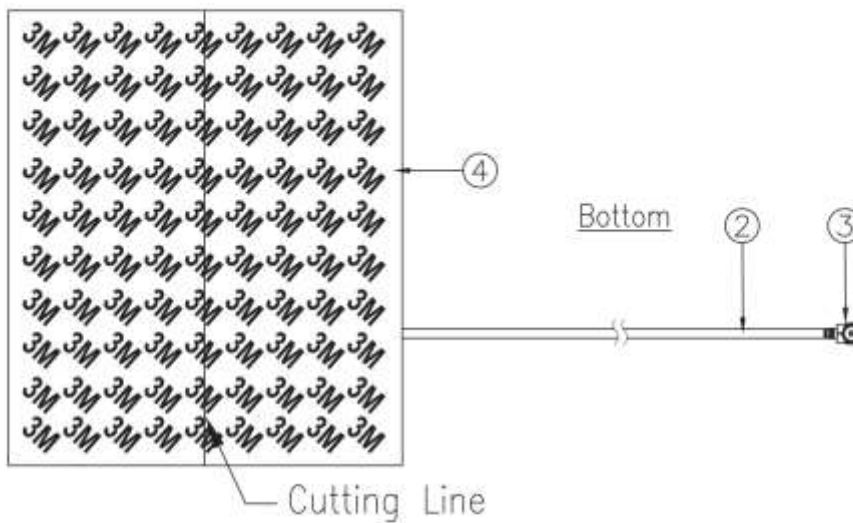
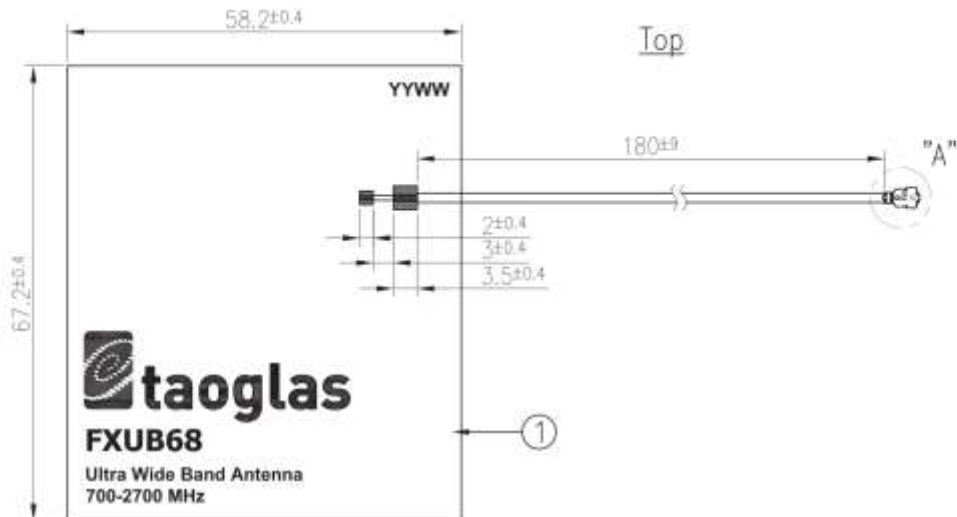

	Name	Material	Finish	QTY
1	FXUB68 FPCB	Polymer	Black	1
2	1.37 Coaxial Cable	FEP	Black	1
3	IPEX MHFHT	Brass	Gold	1
4	Double-Sided Adhesive	3M 467	Brown Liner	1

## 6. Packaging

100pcs FXUB68.07.0180C per PE Bag  
 Bag Dimensions - 300 x 160mm  
 Weight - 241g



1000pcs FXUB68.07.0180C per PE Large Bag  
 Bag Dimensions - 380 x 280mm  
 Weight - 2.6kg

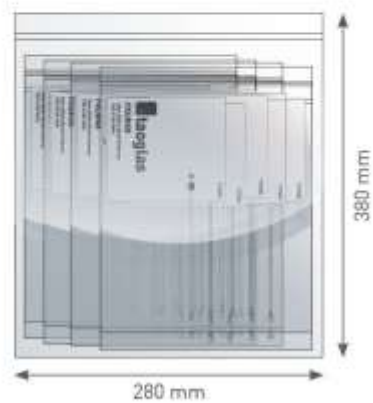

5,000 pcs FXUB68.07.0180C per carton  
 Carton - 320 x 250 x 230mm  
 Weight - 13.5Kg

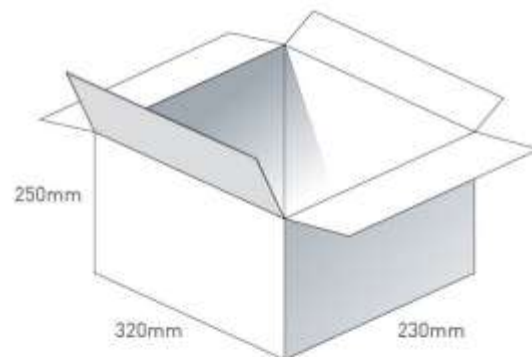

Pallet Dimensions 960 x 1000 x 1300mm  
 60 Cartons per Pallet  
 12 Cartons per layer  
 5 Layers

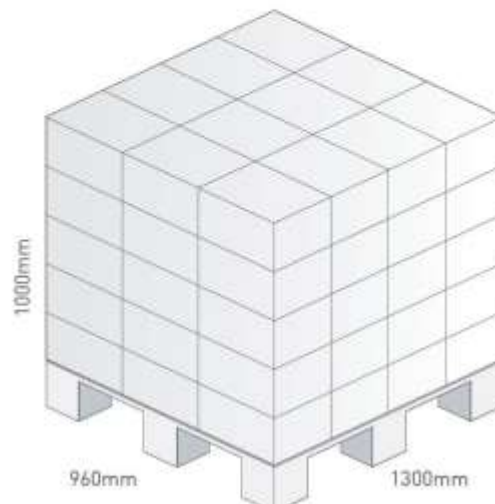

## 7. Application Note

Like all flex antennas, the FXUB65 Minima antenna performance is somewhat sensitive to the routing of the cable during integration. The preferred routing is a “full wrap” or “half wrap”, as shown below where the cable is routed around the long side of the device. Routing over the lower part of the device as shown will also work well. An integration where the cable runs straight off will work, but the performance in the 900MHz band may not be optimal. Avoid running the cable up along the short side or wrapping it around the short side, as these will not work. If a longer cable is needed to wrap around the long side and still reach the module, this is ok, and a longer cable can be easily built. Keep the antenna at least 20mm away from conductors in the end user device.

The FXUB65 can be integrated into assemblies over a small ground plane such as a PCB. The efficiency in these cases can sometimes be higher than the antenna alone.





Changelog for the datasheet

**SPE-16-8-023 – FXUB68.07.0180C**

**Revision: C (Current Version)**

Date:	15/02/21
Changes:	Update to new datasheet template.
Changes Made by:	Gary West

**Previous Revisions**

**Revision: B**

Date:	30/03/2017
Changes:	Updated Spec with LTE table
Changes Made by:	Andy Mahoney

**Revision: A (Original First Release)**

Date:	4/21/2016
Notes:	
Author:	Jack Conroy



[www.taoglas.com](http://www.taoglas.com)

