



# TAOGLAS®



# Datasheet

## Adhesive Antenna

**Part No:**  
GSA.8846.A.105111

### Description

IP67 Rated Wideband 5G/4G Adhesive Mount Antenna

### Features:

- 450-470MHz and 698-6000MHz Coverage
- Suitable for 5G/4G/Wi-Fi Applications
- Adhesive Mount Antenna
- IP67 Rated Enclosure
- Cable: 1m TGC-200
- Connector: SMA(M)
- Dimensions: 176mm \* 59mm \* 11.6mm
- RoHS & Reach Compliant

<b>1.</b>	<b>Introduction</b>	<b>2</b>
<b>2.</b>	<b>Specification</b>	<b>3</b>
<b>3.</b>	<b>Antenna Characteristics</b>	<b>6</b>
<b>4.</b>	<b>Radiation Patterns</b>	<b>9</b>
<b>5.</b>	<b>Mechanical Drawing</b>	<b>40</b>
<b>6.</b>	<b>Packaging</b>	<b>41</b>
<b>7.</b>	<b>Application Note</b>	<b>42</b>
<hr/>		
	Changelog	48

Taoglas makes no warranties based on the accuracy or completeness of the contents of this document and reserves the right to make changes to specifications and product descriptions at any time without notice. Taoglas reserves all rights to this document and the information contained herein. Reproduction, use or disclosure to third parties without express permission is strictly prohibited.



# 1. Introduction



The Taoglas GSA.8846 Wideband Dipole Antenna has been designed to cover all Cellular, ISM and Wi-Fi working frequencies in the 450-6000 MHz spectrum. It has the highest wide-band efficiency in its range of any I-Bar style antenna on the market today.

The GSA.8846 has been primarily designed for use with 4G LTE modules and devices that require the highest possible efficiency and peak gain to deliver best in class throughput on all major cellular (4G/3G/2G) bands worldwide, vital for applications such as high-speed video and real-time streaming, or high-capacity MIMO networks on public transportation.

It is supplied with a 1-meter coaxial cable and SMA (M) connector as standard but both can be customized upon request. The robust, low-profile enclosure is IP67 rated for use in the most demanding of applications. It is for mounting via high quality first tier automotive approved 3M adhesive foam.

The GSA.8846 exhibits high efficiency and is backward compatible with 3G and 2G cellular applications such as GSM, LTE, UMTS, and Wi-Fi.

It is an ideal solution for any device requiring high, reliable performance. It is also guaranteed to meet any type approval or carrier certification requirements from an efficiency standpoint. The antenna also makes an excellent reference antenna for test purposes. It has been designed as an omnidirectional antenna, as can be seen in the radiation patterns, which is stable across all bands.

Contact your regional customer support team for further information.

## 2. Specification

Electrical										
Band	Frequency (MHz)	Set-up	Efficiency (%)	Average Gain (dB)	Peak Gain (dBi)	Impedance	Polarization	Radiation Pattern	Input Power	
LTE 450	450-470	In free space	0.3M	54.59	-2.70	-0.03	50Ω	Linear	Omni	5W
			1M	52.14	-2.90	-0.23				
			2M	48.66	-3.20	-0.53				
			3M	46.47	-3.40	-0.73				
			5M	41.42	-3.90	-1.23				
		On 2mm ABS Base	0.3M	35.95	-4.54	-0.76				
			1M	34.34	-4.74	-0.96				
			2M	32.05	-5.04	-1.26				
			3M	30.61	-5.24	-1.46				
			5M	27.28	-5.74	-1.25				
		On Glass Base	0.3M	19.55	-7.63	-1.88				
			1M	18.67	-7.83	-2.08				
			2M	17.42	-8.13	-2.38				
			3M	16.64	-8.33	-2.58				
			5M	14.83	-8.83	-1.99				
LTE 700	698-806	In free space	0.3M	68.84	-1.78	2.76				
			1M	65.27	-2.02	2.56				
			2M	60.91	-2.32	2.26				
			3M	56.34	-2.65	1.86				
			5M	48.67	-3.28	1.26				
		On 2mm ABS Base	0.3M	68.97	-1.63	2.19				
			1M	65.24	-1.87	1.99				
			2M	60.88	-2.17	1.69				
			3M	56.40	-2.50	1.29				
			5M	48.74	-3.13	0.69				
		On Glass Base	0.3M	67.74	-1.70	1.73				
			1M	64.00	-1.95	1.53				
			2M	59.72	-2.25	1.23				
			3M	55.36	-2.58	0.83				
			5M	47.88	-3.21	0.23				
GSM 850	824-894	In free space	0.3M	76.00	-1.21	2.85				
			1M	72.56	-1.41	2.65				
			2M	66.66	-1.78	2.35				
			3M	61.76	-2.11	1.95				
			5M	52.57	-2.81	1.25				
		On 2mm ABS Base	0.3M	66.19	-1.80	2.42				
			1M	63.20	-2.00	2.22				
			2M	58.05	-2.37	1.92				
			3M	53.79	-2.70	1.52				
			5M	45.78	-3.40	0.82				
		On Glass Base	0.3M	62.39	-2.05	2.09				
			1M	59.59	-2.25	1.89				
			2M	54.72	-2.62	1.59				
			3M	50.72	-2.95	1.19				
			5M	43.17	-3.65	0.49				
GSM 900	880-960	In free space	0.3M	63.84	-1.96	2.13				
			1M	60.97	-2.16	1.93				
			2M	55.61	-2.56	1.53				
			3M	51.59	-2.89	1.23				
			5M	43.62	-3.62	0.53				
		On 2mm ABS Base	0.3M	56.81	-2.46	1.66				
			1M	54.25	-2.66	1.46				
			2M	49.48	-3.06	1.06				
			3M	45.90	-3.39	0.76				
			5M	38.81	-4.12	0.06				
		On Glass Base	0.3M	53.07	-2.82	1.78				
			1M	50.71	-3.02	1.58				
			2M	46.25	-3.42	1.18				
			3M	42.94	-3.75	0.88				
			5M	36.30	-4.47	0.18				
DCS	1710-1880	In free space	0.3M	71.41	-1.46	2.83				
			1M	65.15	-1.86	2.43				
			2M	58.06	-2.36	1.93				
			3M	51.62	-2.87	1.43				
			5M	40.68	-3.91	0.43				
		On 2mm ABS Base	0.3M	61.27	-2.13	2.24				
			1M	55.89	-2.53	1.84				
			2M	49.81	-3.03	1.34				
			3M	44.29	-3.54	0.84				
			5M	34.91	-4.58	-0.26				
		On Glass Base	0.3M	66.77	-1.76	4.94				
			1M	60.90	-2.16	4.54				
			2M	54.28	-2.66	4.04				
			3M	48.25	-3.17	3.44				
			5M	38.04	-4.20	2.44				

<b>PCS</b>	<b>1850-1990</b>	In free space	0.3M	60.60	-2.20	2.71
			1M	55.27	-2.60	2.31
			2M	48.66	-3.16	1.81
			3M	43.04	-3.69	1.31
			5M	33.74	-4.74	0.21
		On 2mm ABS Base	0.3M	56.23	-2.51	2.60
			1M	51.26	-2.91	2.20
			2M	45.13	-3.46	1.68
			3M	39.90	-4.00	1.10
			5M	31.30	-5.05	0.10
		On Glass Base	0.3M	66.14	-1.80	5.34
			1M	60.30	-2.20	4.94
			2M	53.08	-2.76	4.40
			3M	46.93	-3.29	3.84
			5M	36.82	-4.34	2.84
<b>UMTS1</b>	<b>1920-2170</b>	In free space	0.3M	66.79	-1.80	4.25
			1M	61.44	-2.17	3.85
			2M	53.84	-2.74	3.35
			3M	47.59	-3.27	2.75
			5M	37.06	-4.36	1.65
		On 2mm ABS Base	0.3M	59.11	-2.30	3.65
			1M	54.34	-2.66	3.34
			2M	47.62	-3.24	2.75
			3M	42.10	-3.77	2.15
			5M	32.80	-4.86	1.05
		On Glass Base	0.3M	67.56	-1.71	5.34
			1M	62.12	-2.07	4.94
			2M	54.43	-2.65	4.36
			3M	48.12	-3.18	3.84
			5M	37.50	-4.27	2.84
<b>LTE 2600</b>	<b>2300-2690</b>	In free space	0.3M	74.19	-1.32	3.95
			1M	67.65	-1.72	3.55
			2M	58.57	-2.34	2.95
			3M	50.96	-2.95	2.25
			5M	38.51	-4.17	1.05
		On 2mm ABS Base	0.3M	59.92	-2.25	2.95
			1M	54.64	-2.65	2.55
			2M	47.33	-3.27	1.95
			3M	41.20	-3.88	1.35
			5M	31.13	-5.10	0.15
		On Glass Base	0.3M	57.39	-2.47	4.51
			1M	52.35	-2.87	4.11
			2M	45.38	-3.50	3.41
			3M	39.52	-4.10	2.81
			5M	29.88	-5.32	1.51
<b>C-Band</b>	<b>3400-3800</b>	In free space	0.3M			
			1M	29.12	-4.96	0.59
			2M			
			3M			
			5M			
		On 2mm ABS Base	0.3M			
			1M	33.6	-4.84	1.76
			2M			
			3M			
			5M			
		On Glass Base	0.3M			
			1M	37.6	-4.28	3.22
			2M			
			3M			
			5M			
<b>WIFI 5G</b>	<b>4900-5850</b>	In free space	0.3M	62.65	-2.10	6.02
			1M	53.79	-2.76	5.32
			2M	43.57	-3.67	4.42
			3M	35.29	-4.58	3.52
			5M	23.13	-6.41	1.72
		On 2mm ABS Base	0.3M	59.13	-2.31	5.63
			1M	50.80	-2.97	4.93
			2M	41.16	-3.88	4.03
			3M	33.36	-4.79	3.13
			5M	21.88	-6.62	1.33
		On Glass Base	0.3M	49.94	-3.04	4.94
			1M	42.92	-3.69	4.24
			2M	34.76	-4.61	3.34
			3M	28.18	-5.52	2.44
			5M	18.48	-7.35	0.64

<b>Mechanical</b>	
<b>Casing</b>	ABS
<b>Coaxial Cable</b>	TGC-200 Low Loss Cable
<b>Cable Length</b>	1 Meter Standard, Fully Customizable
<b>Connector</b>	SMA Male Standard, Fully Customizable
<b>Adhesive</b>	3M9448+CR4305 Double Sided Adhesive
<b>Weight</b>	127g

<b>Environmental</b>	
<b>Ingress Protection</b>	IP67
<b>Operation Temperature Range</b>	-40°C to 85°C
<b>Storage Temperature Range</b>	-40°C to 85°C
<b>Humidity</b>	Non-condensing 65°C 95% RH

### 3. Antenna Characteristics

#### 3.1 Return Loss

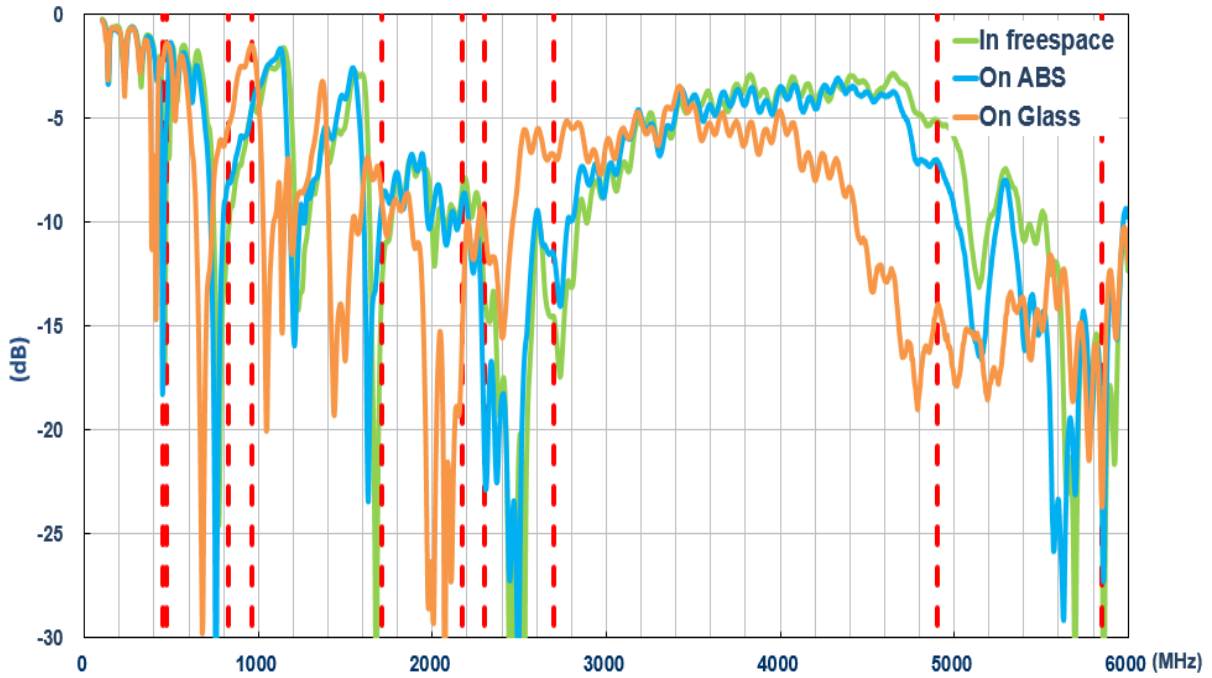

#### 3.2 Efficiency

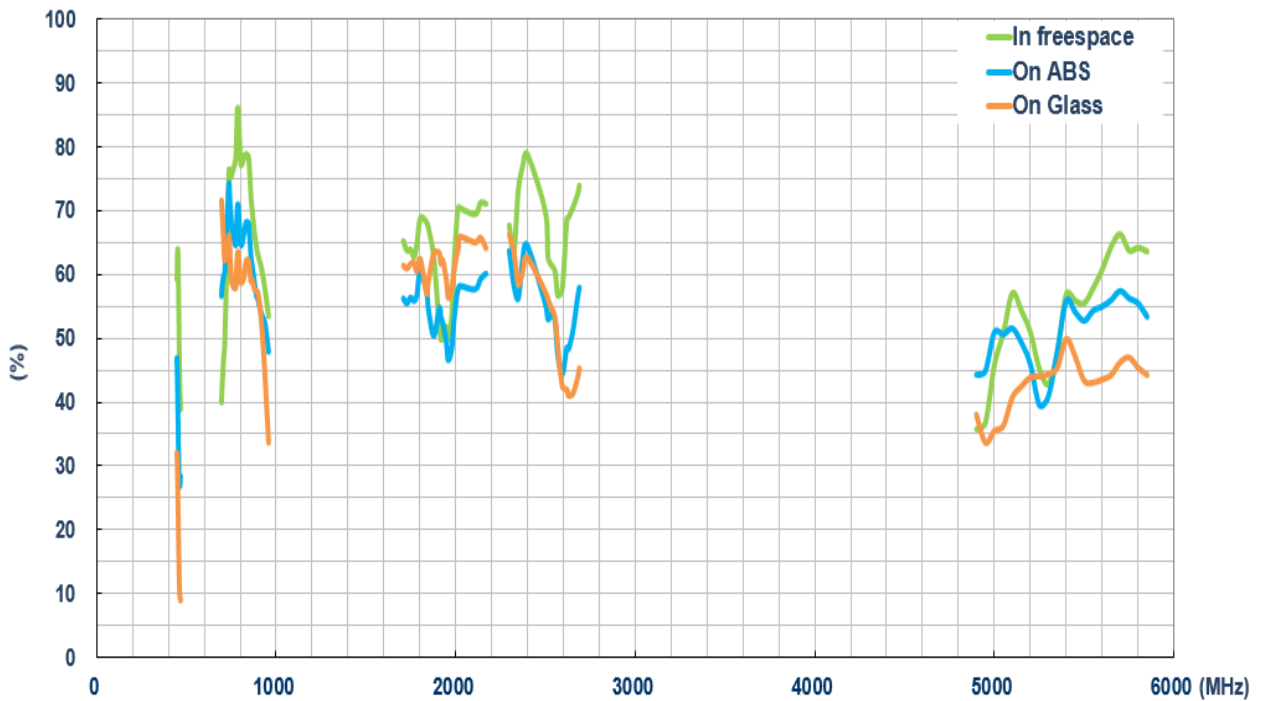

### 3.3 Average Gain

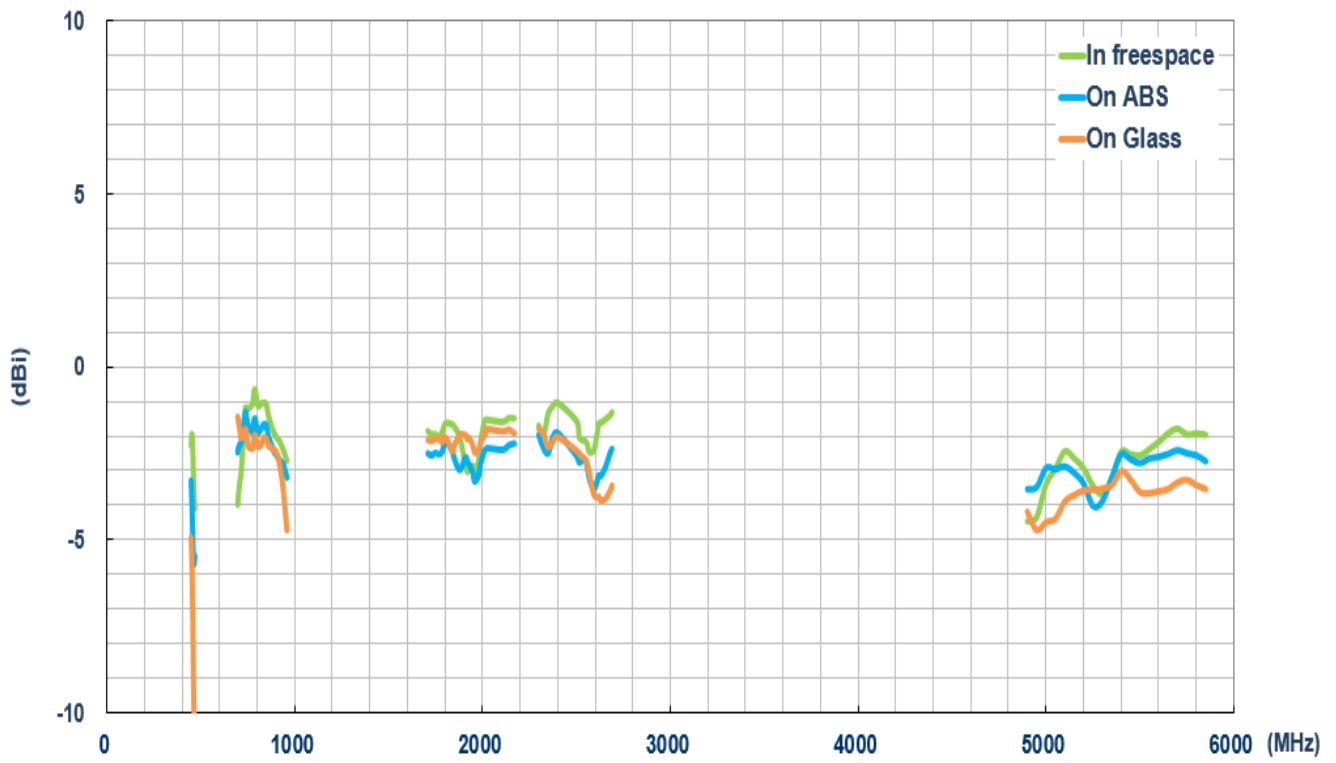

### 3.4 Peak Gain

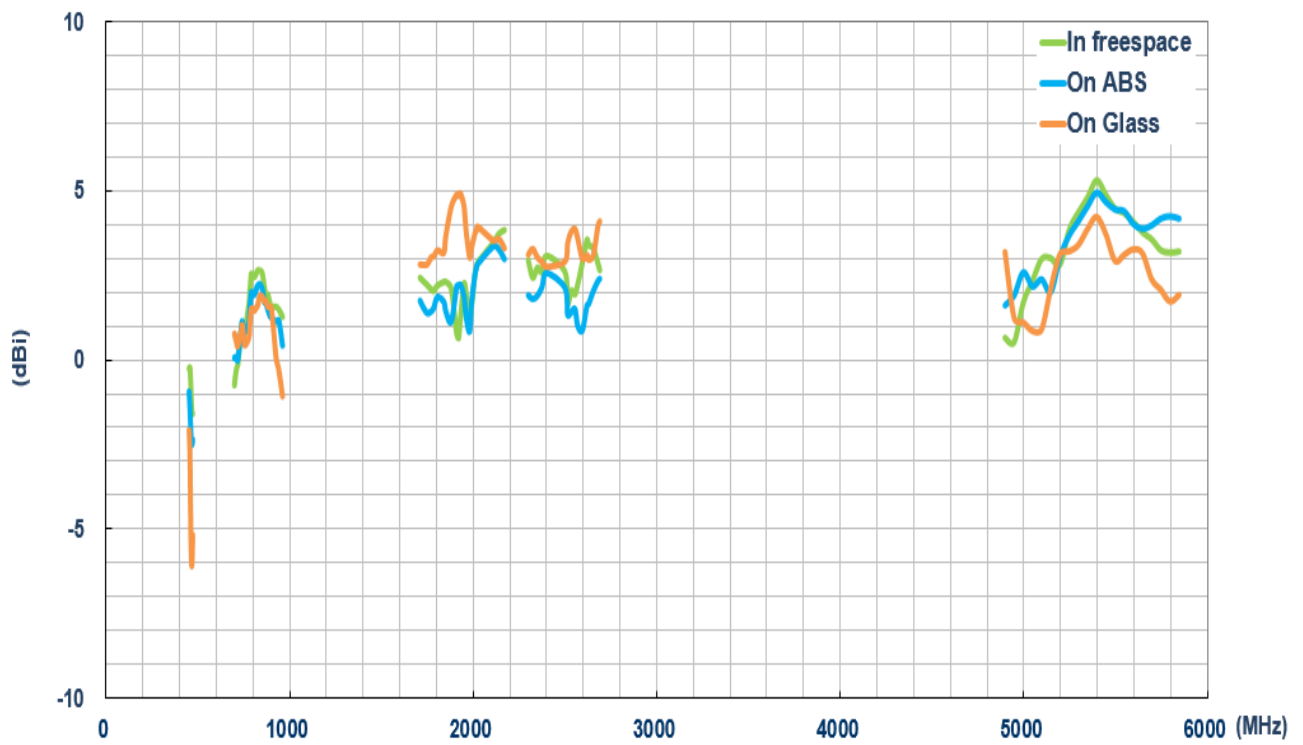



### 3.5 Average Gain (3000-5000MHz)

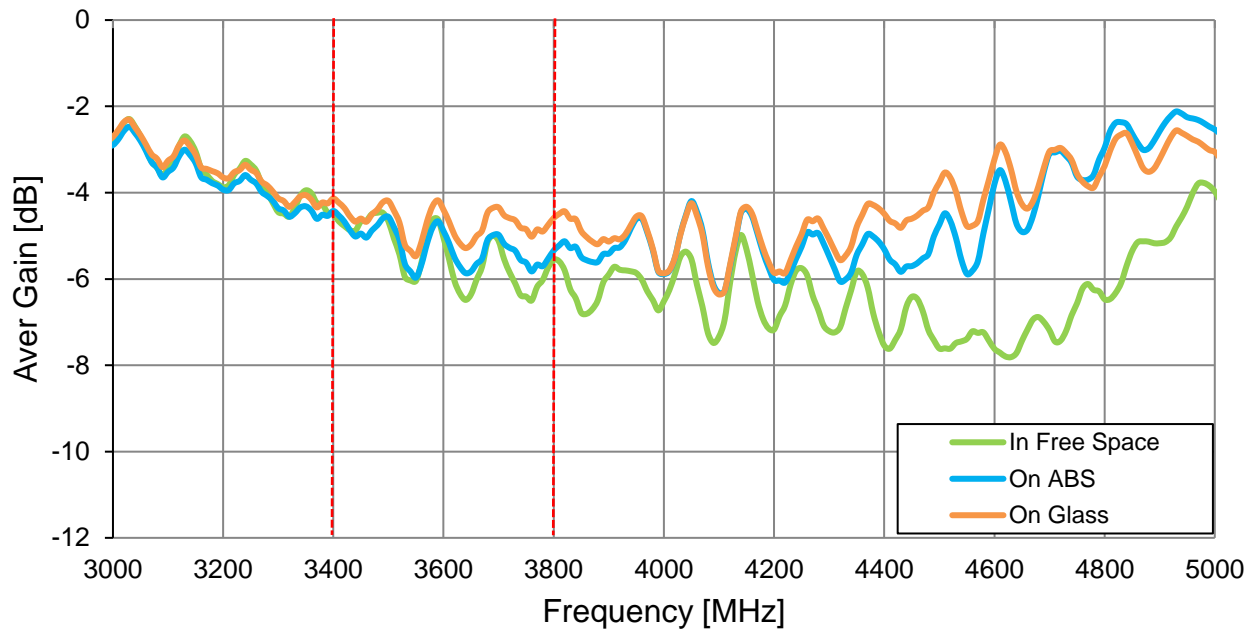

### 3.6 Peak Gain (3000-5000MHz)

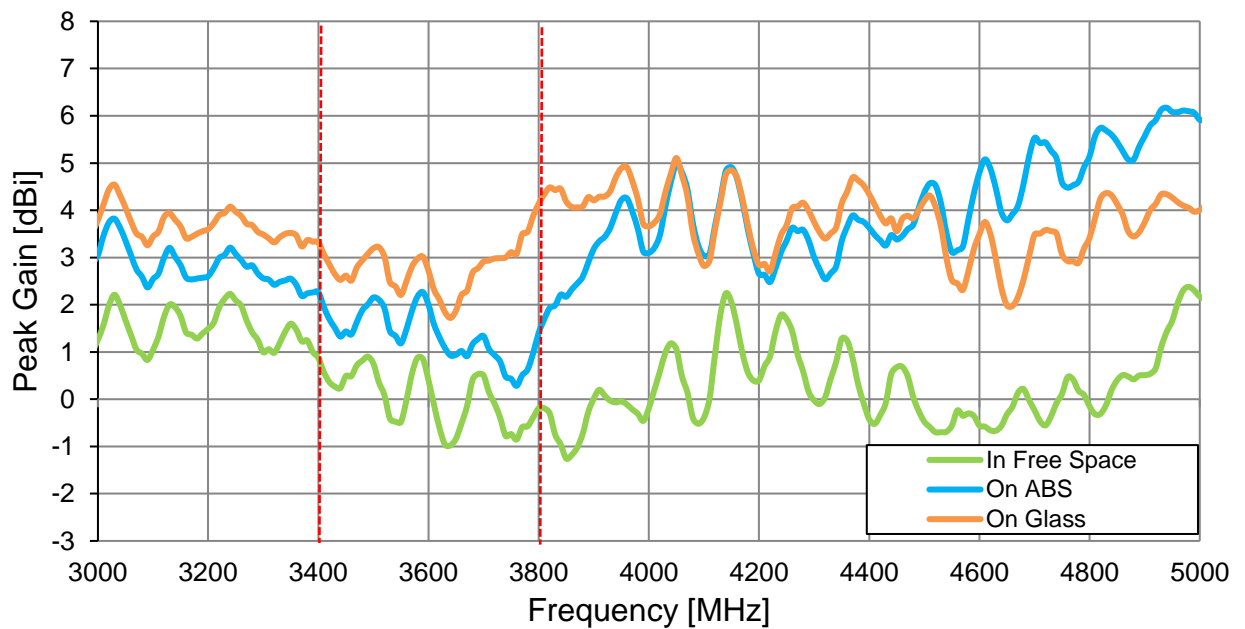

# 4. Radiation Patterns

## 4.1 Test Setup

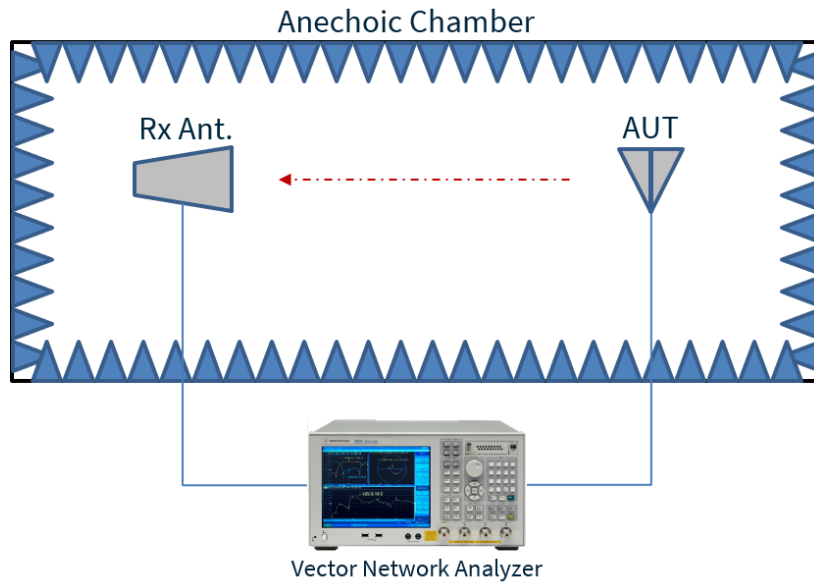

In Free space



On 2mm ABS



On Glass

4.2 Free space (1m Cable) Patterns at 450 MHz

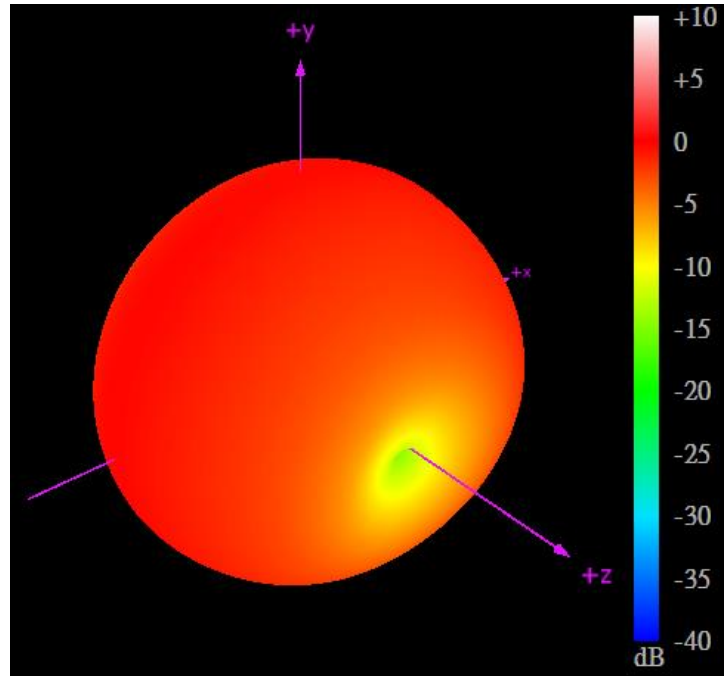

XZ Plane                      YZ Plane                      XY Plane

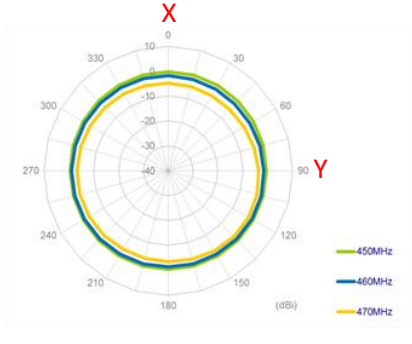
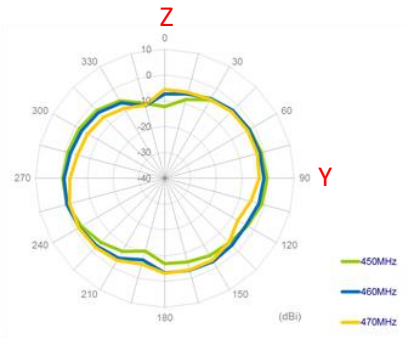
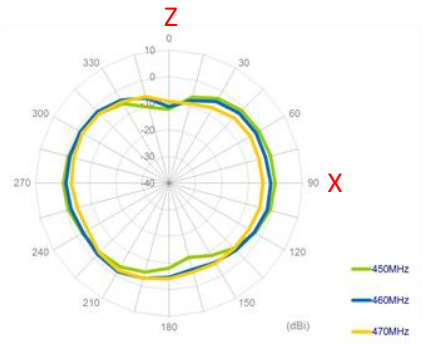

4.3 Free space (1m Cable) Patterns at 470 MHz

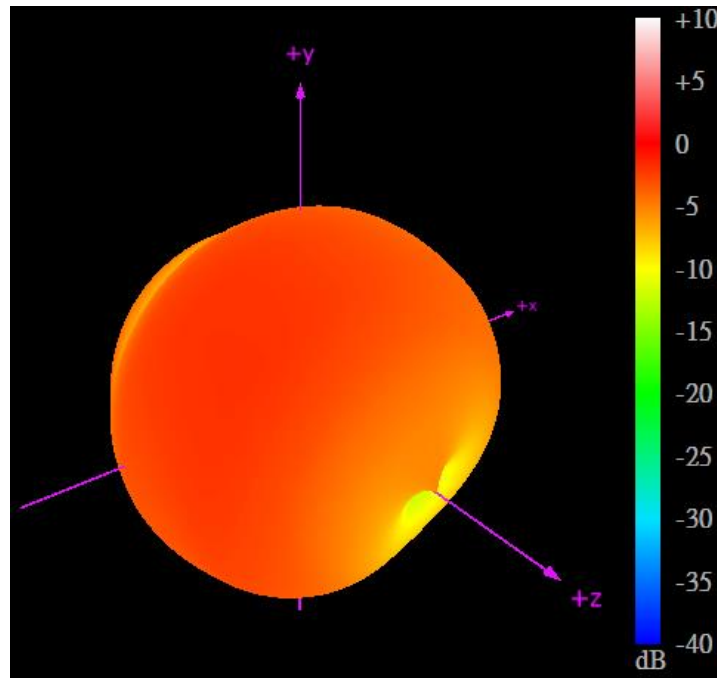

XZ Plane                      YZ Plane                      XY Plane

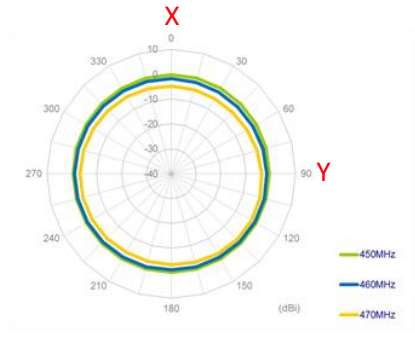
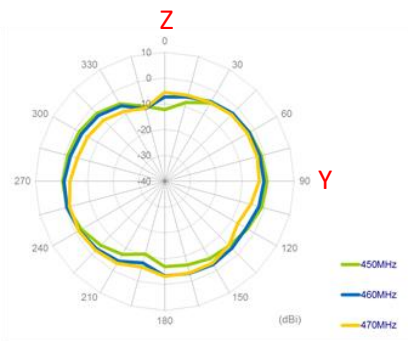
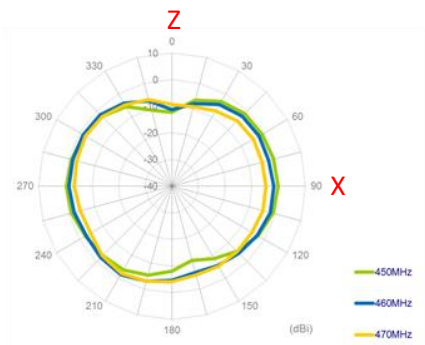

4.4 Free space (1m Cable) Patterns at 704MHz

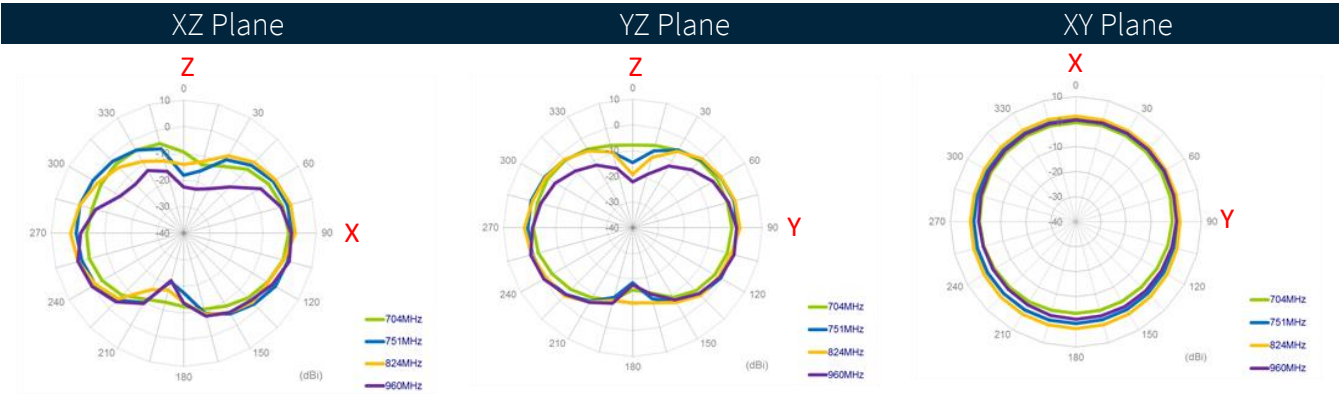
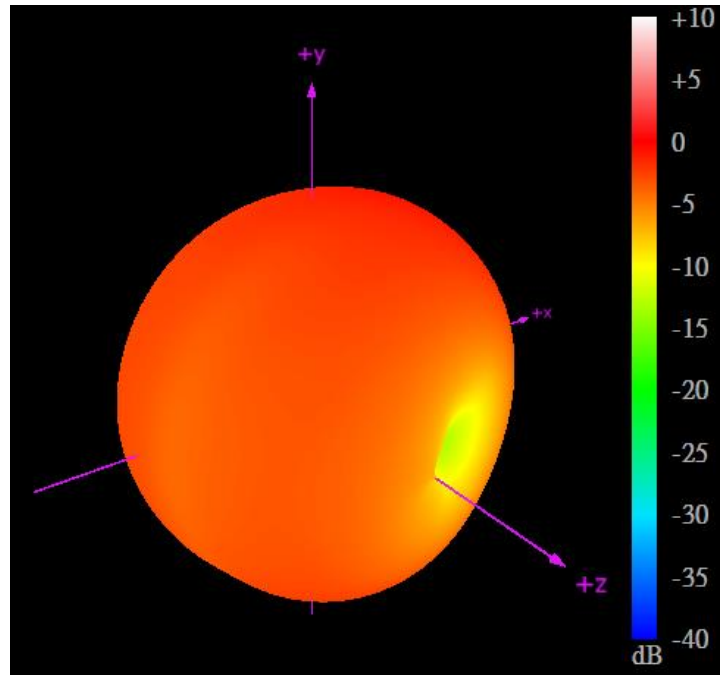

## 4.5 Free space (1m Cable) Patterns at 960MHz

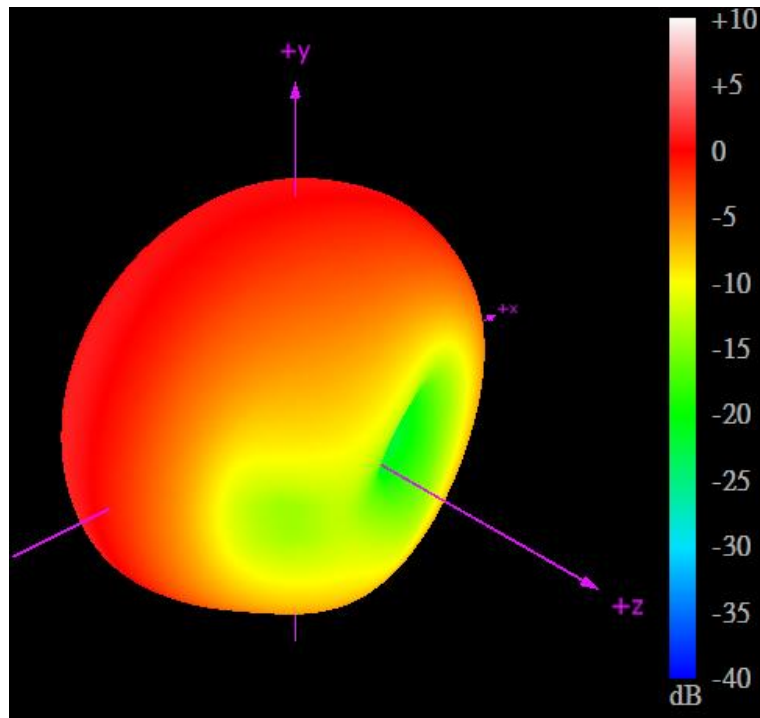

XZ Plane                      YZ Plane                      XY Plane

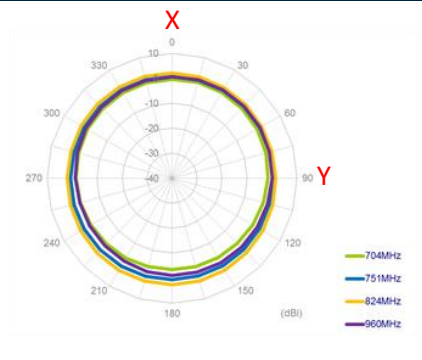
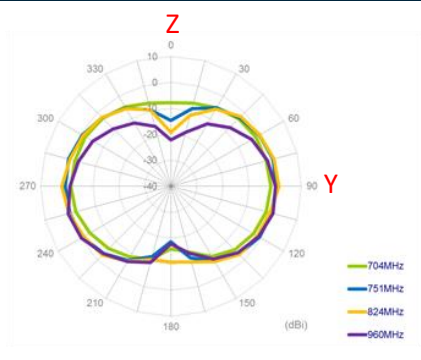
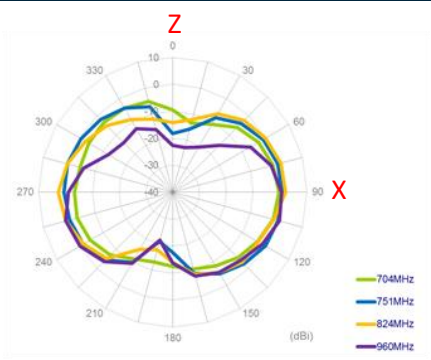

4.6 Free space (1m Cable) Patterns at 1710MHz

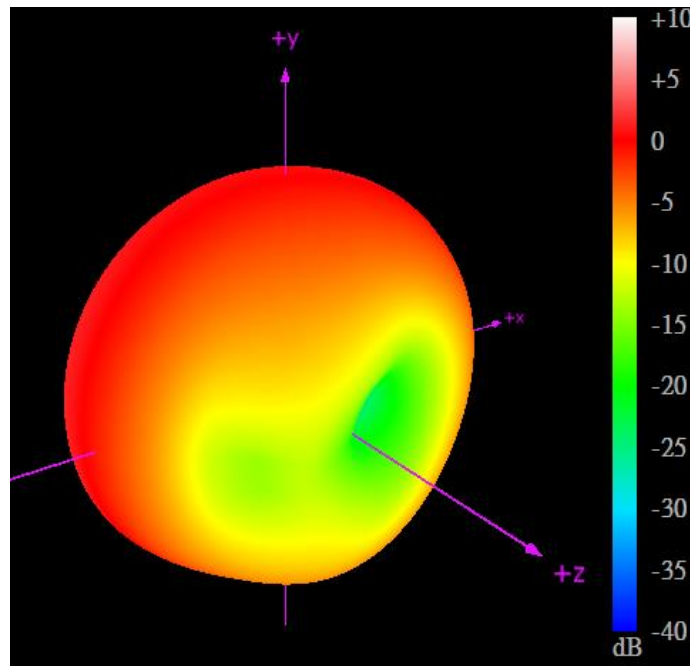

XZ Plane      YZ Plane      XY Plane

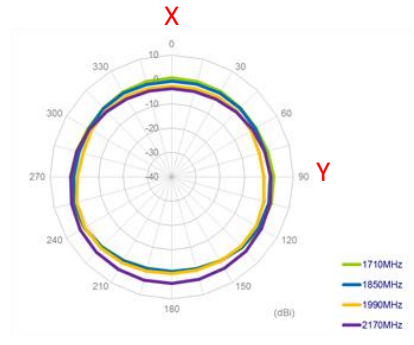
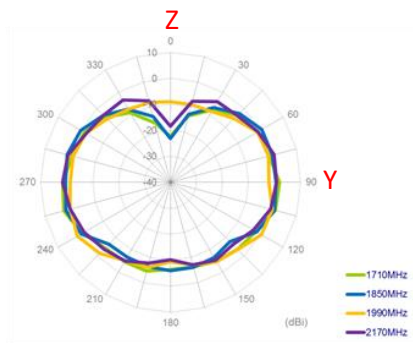
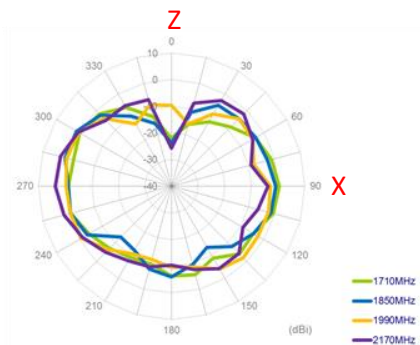

4.7 Free space (1m Cable) Patterns at 2170MHz

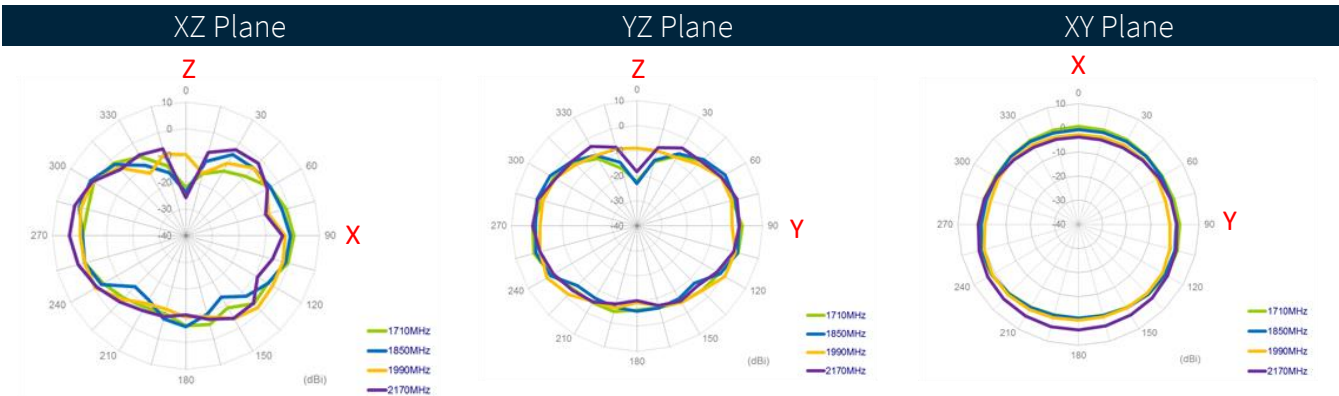
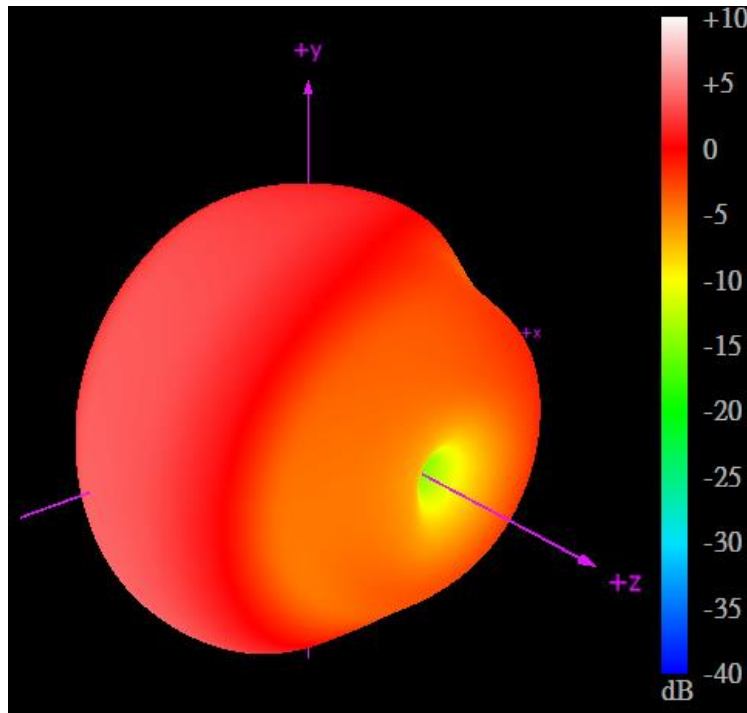



4.8 Free space (1m Cable) Patterns at 2500MHz

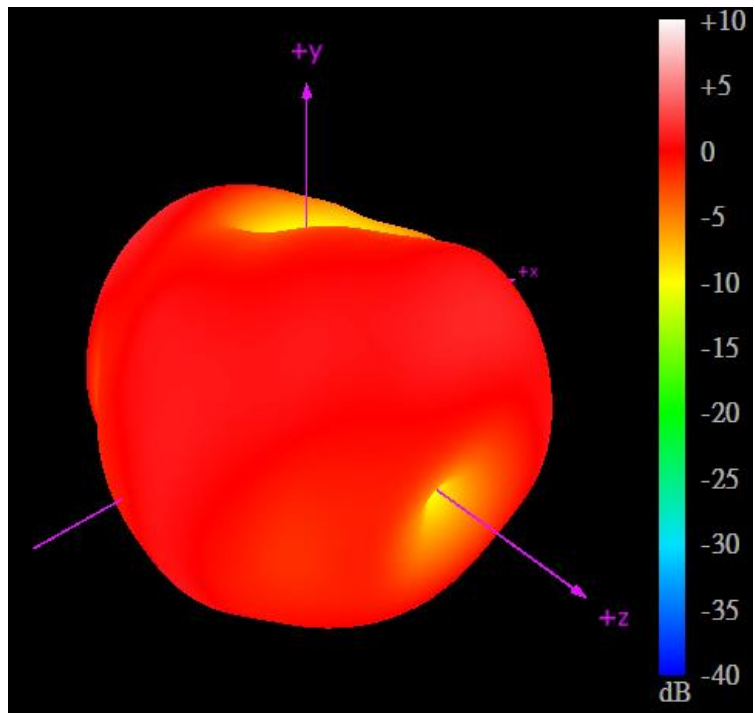

XZ Plane      YZ Plane      XY Plane

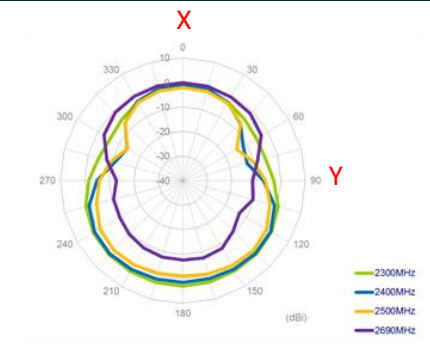
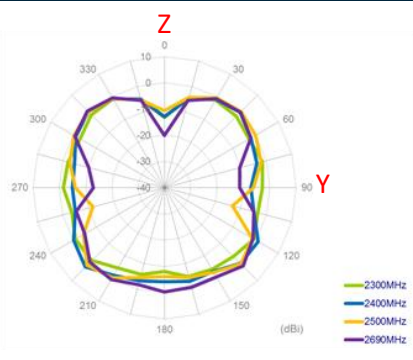

4.9 Free space (1m Cable) Patterns at 2690MHz

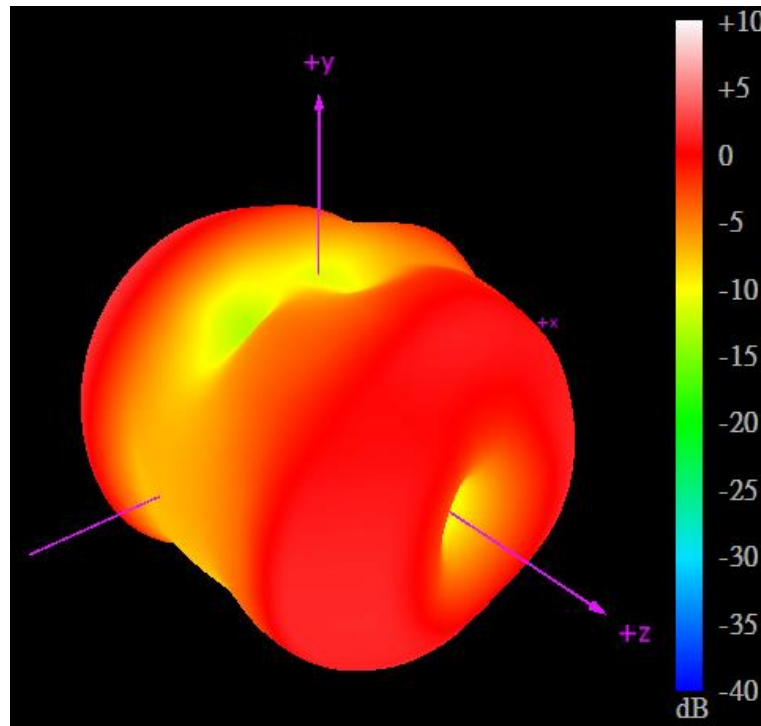

XZ Plane      YZ Plane      XY Plane

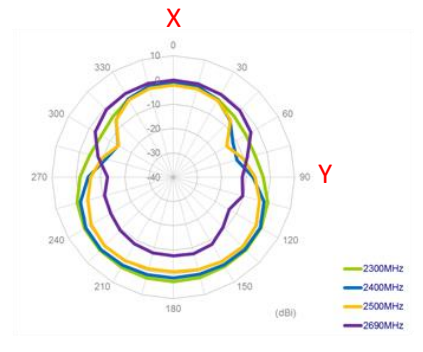
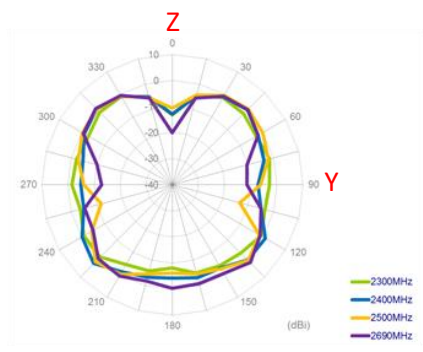
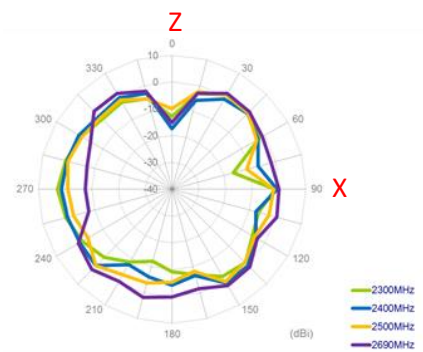

4.10 Free space (1m Cable) Patterns at 5150MHz

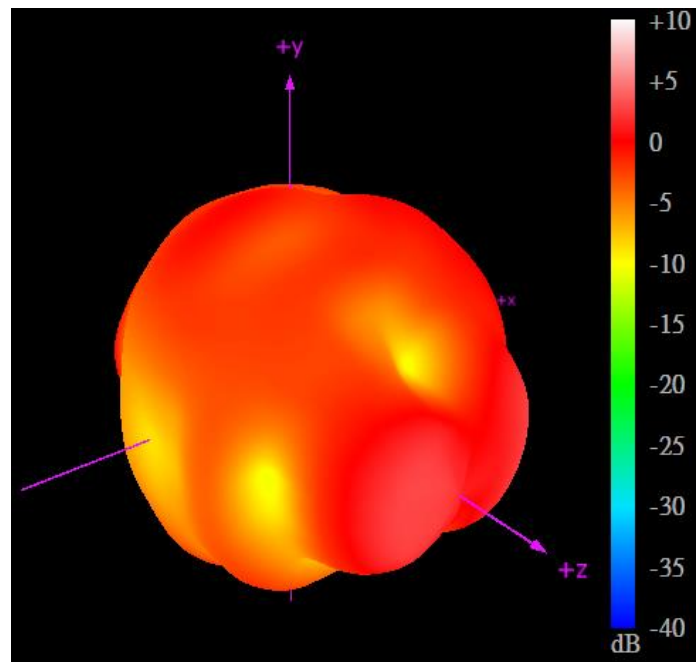

XZ Plane      YZ Plane      XY Plane

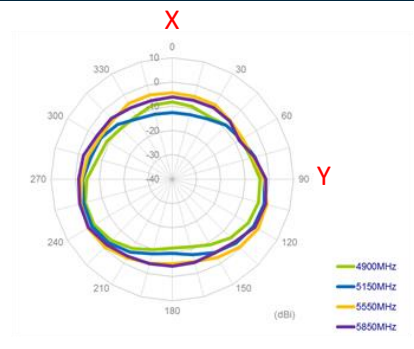
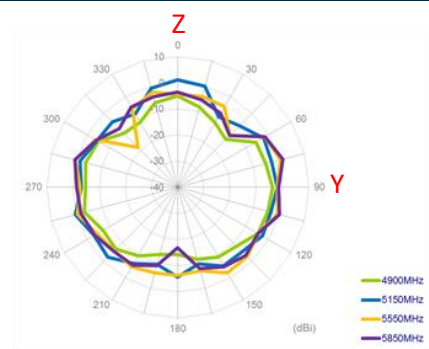
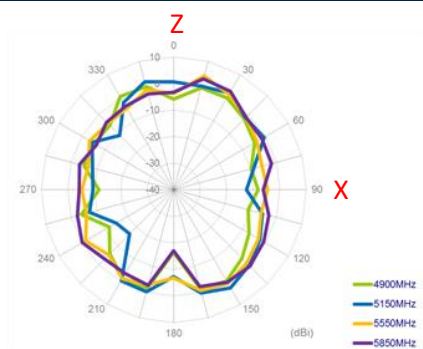

4.11 Free space (1m Cable) Patterns at 5850MHz

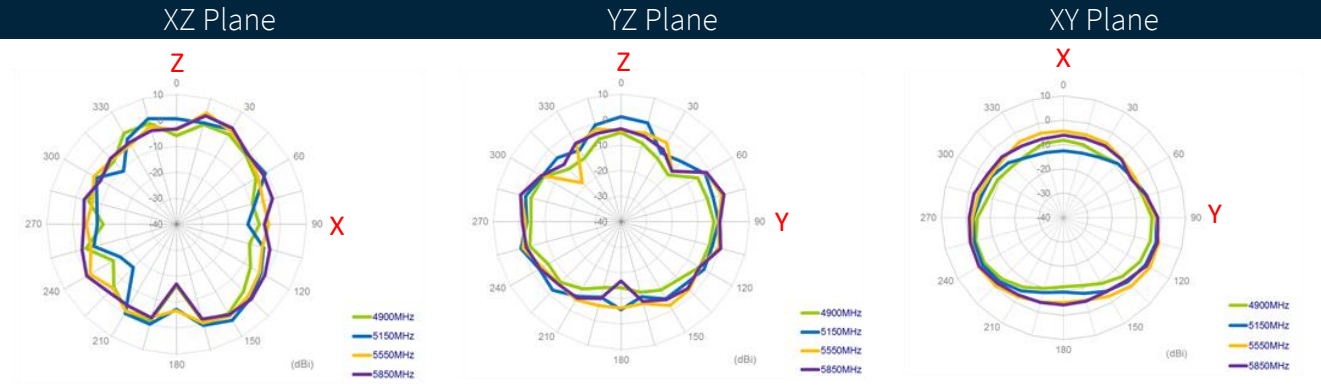
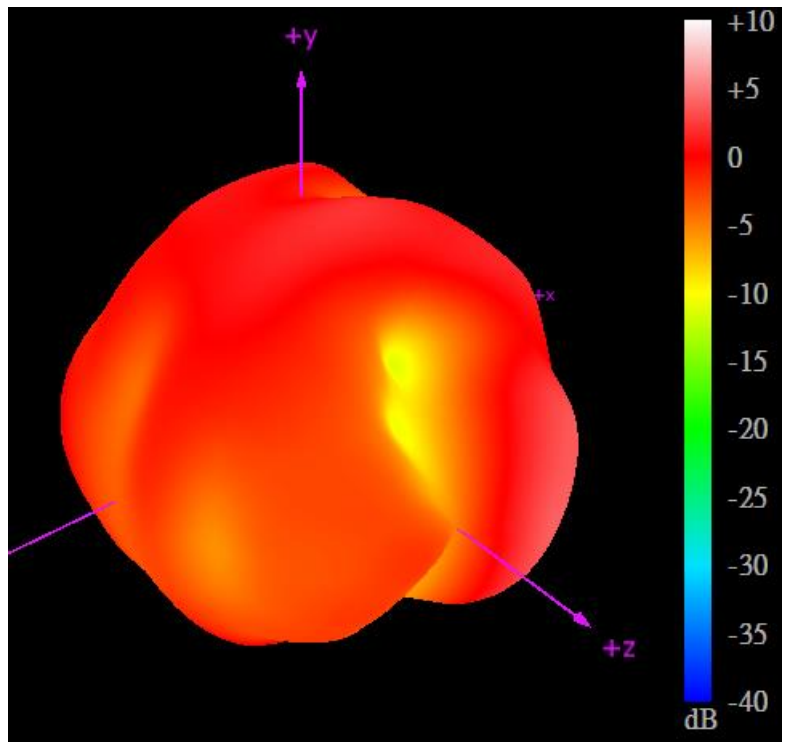

4.12 2mm ABS (1m Cable) Patterns at 450 MHz

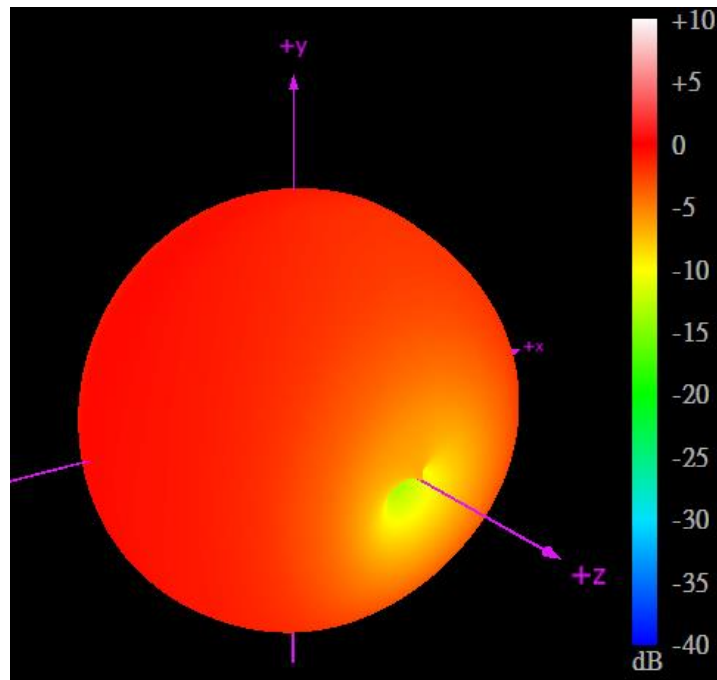

XZ Plane      YZ Plane      XY Plane

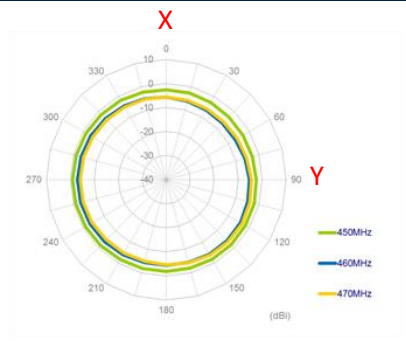
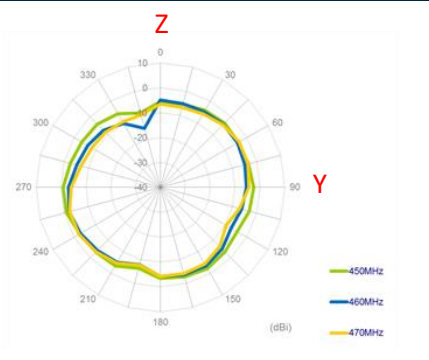
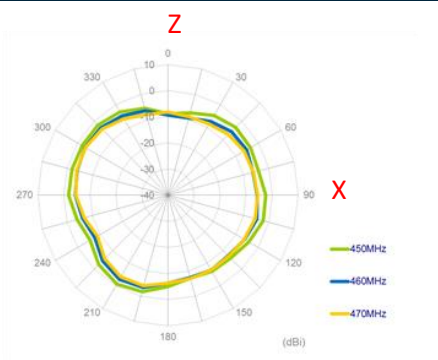

4.13 2mm ABS (1m Cable) Patterns at 470 MHz

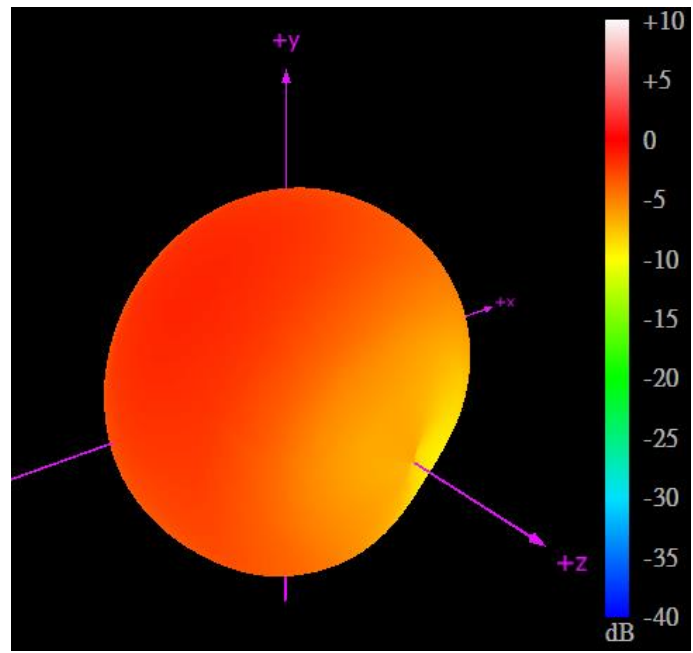

XZ Plane YZ Plane XY Plane

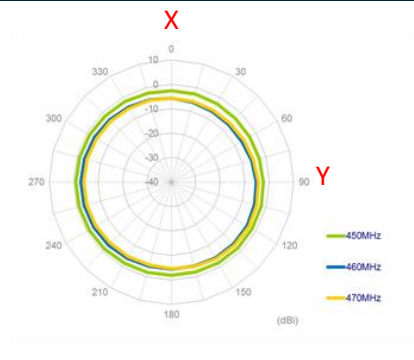
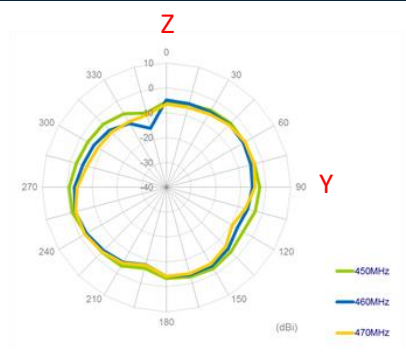
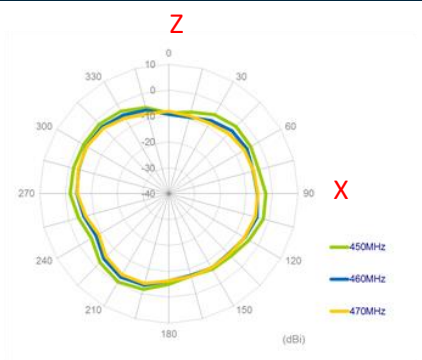

4.14 2mm ABS (1m Cable) Patterns at 704MHz

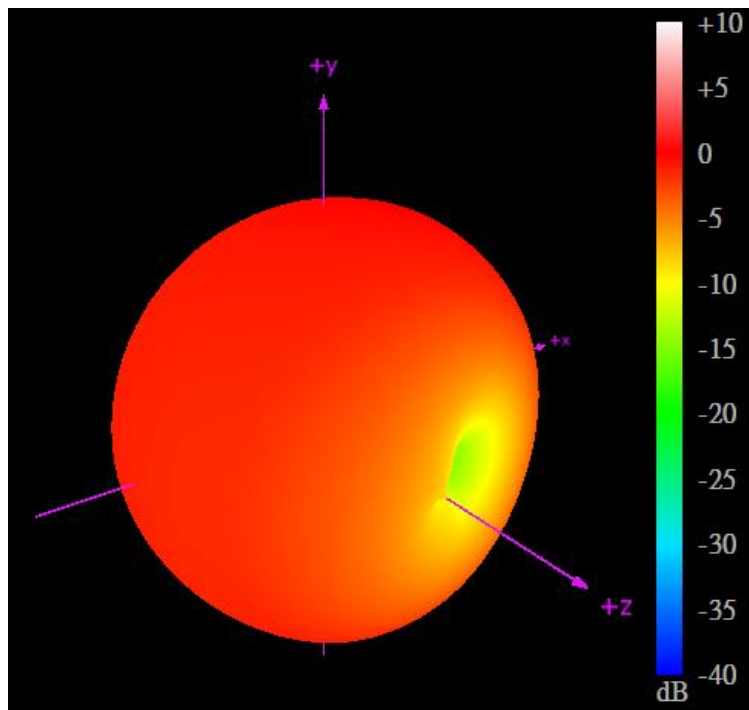

XZ Plane      YZ Plane      XY Plane

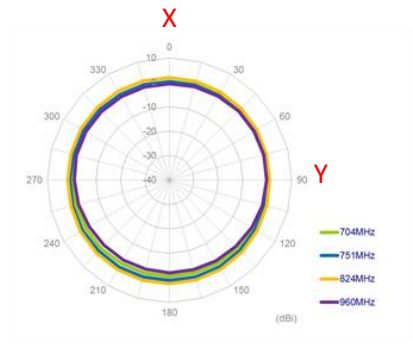
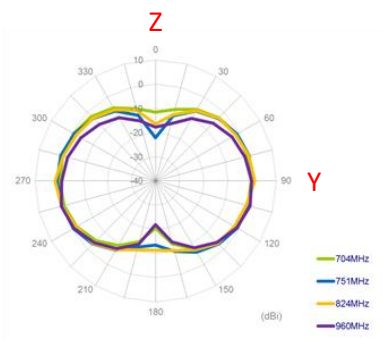
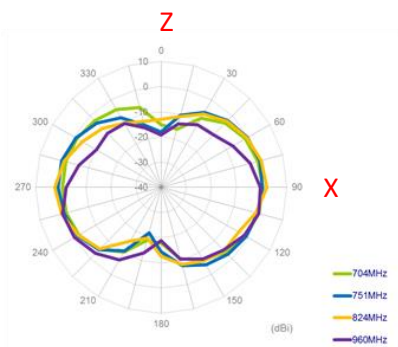

4.15 2mm ABS (1m Cable) Patterns at 960MHz

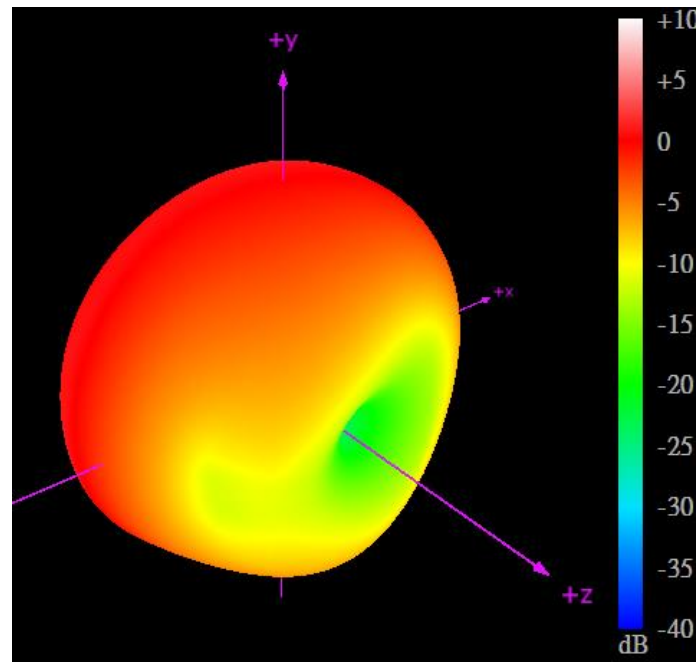

XZ Plane      YZ Plane      XY Plane

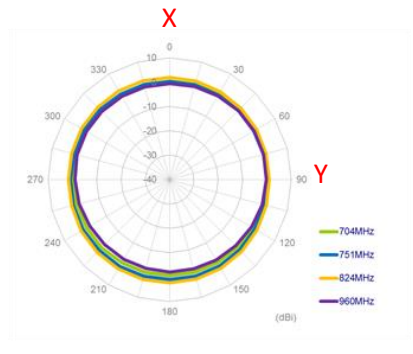
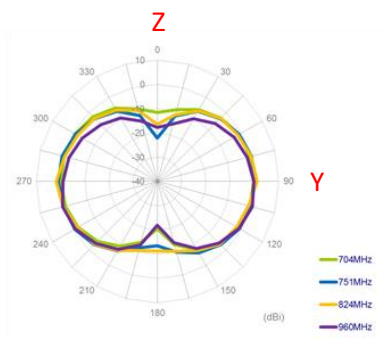
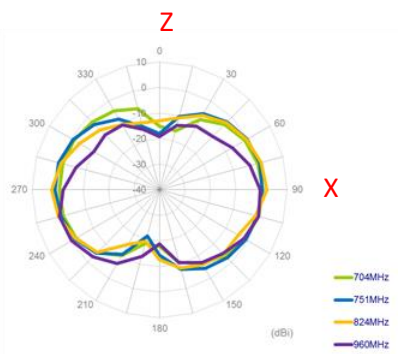



4.16 2mm ABS (1m Cable) Patterns at 1710MHz

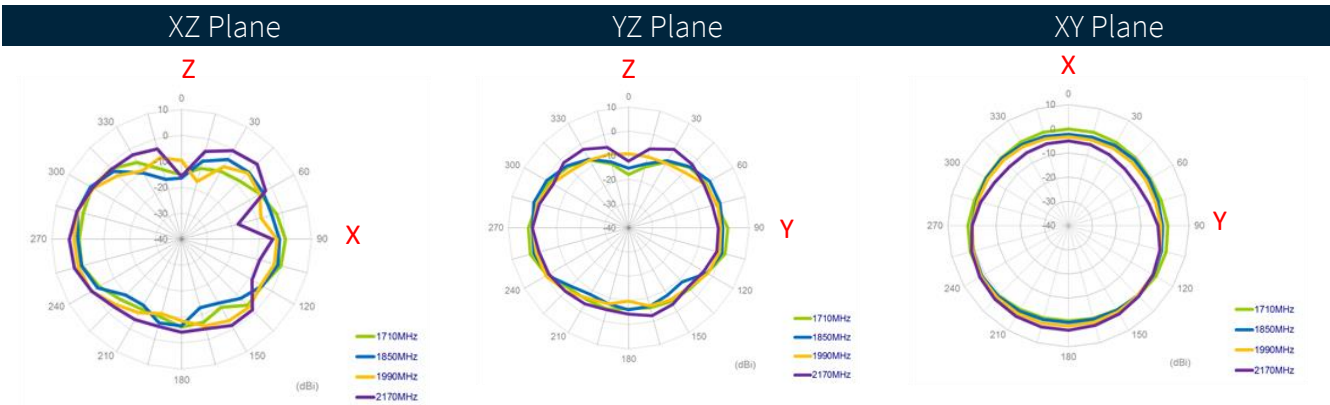
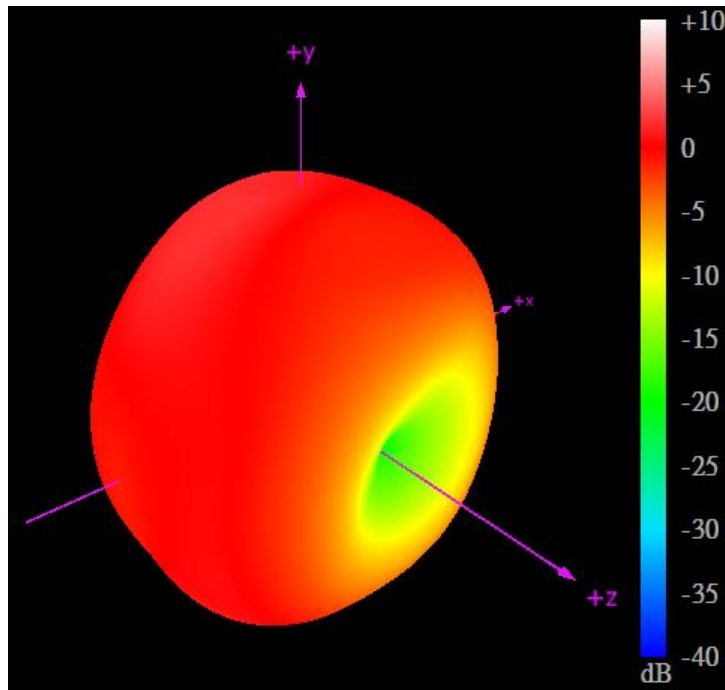

4.17 2mm ABS (1m Cable) Patterns at 2170MHz

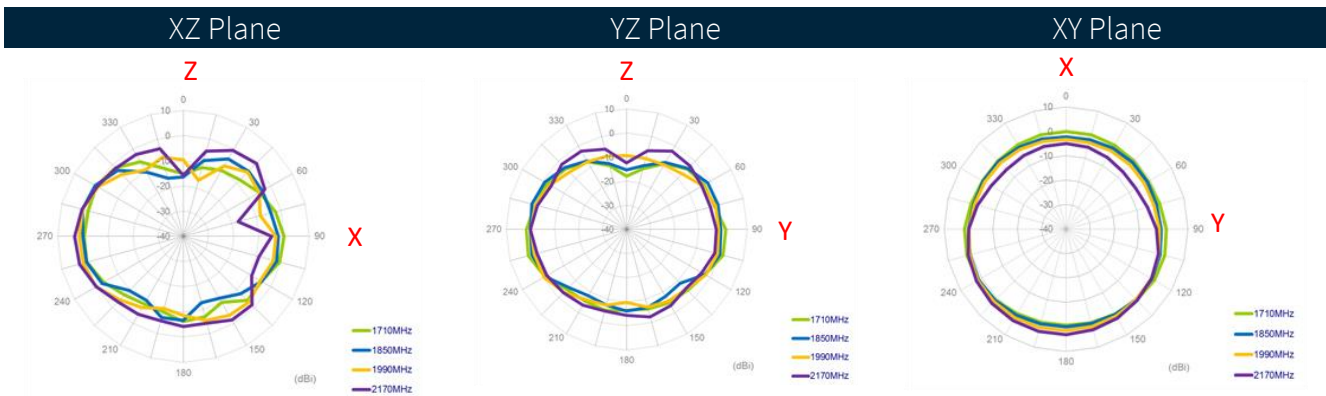
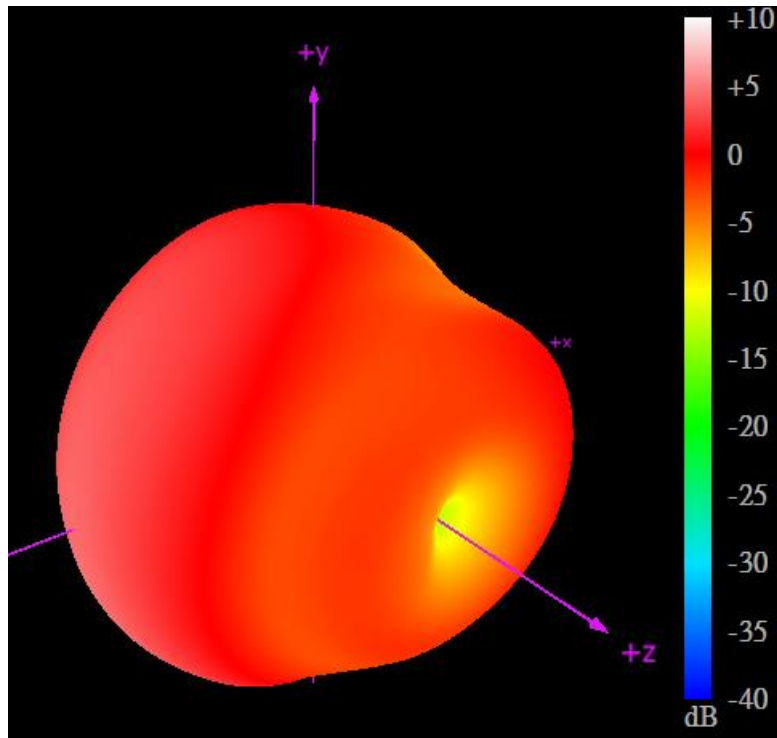

4.18 2mm ABS (1m Cable) Patterns at 2500MHz

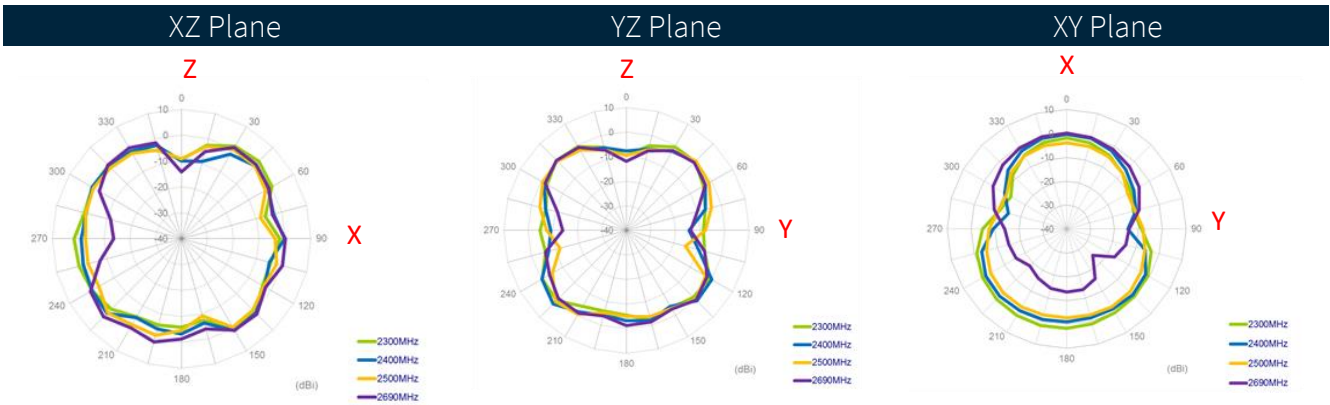
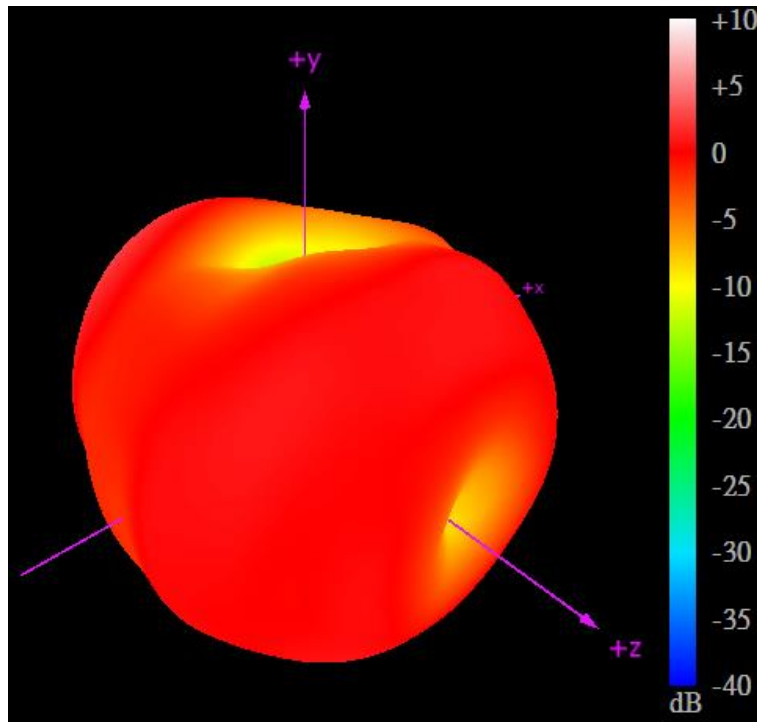

4.19 2mm ABS (1m Cable) Patterns at 2690MHz

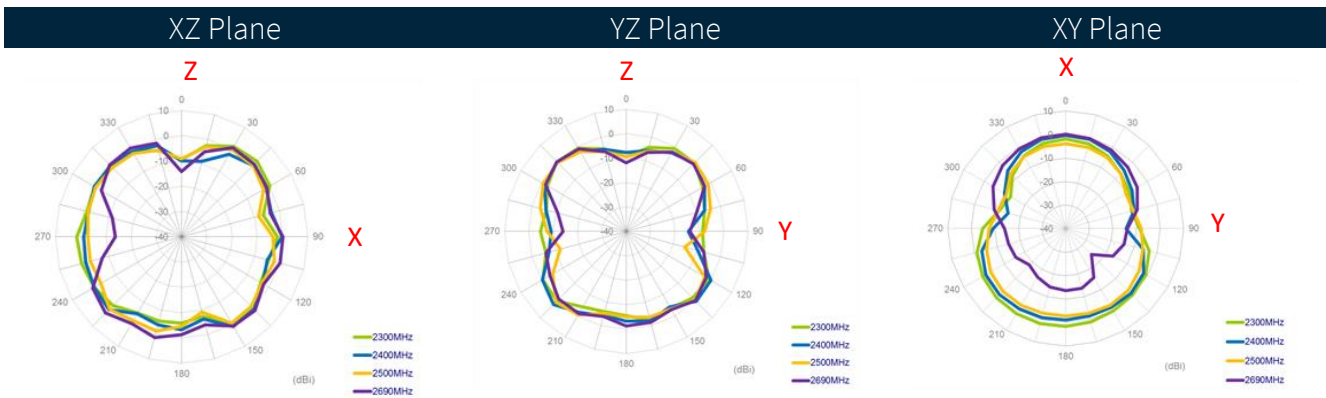
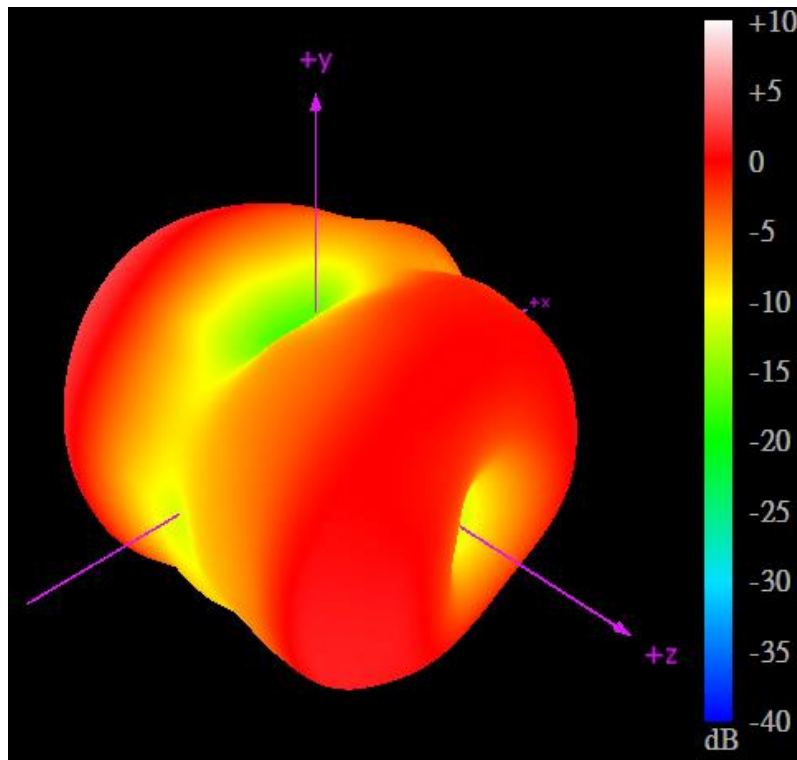

4.20 2mm ABS (1m Cable) Patterns at 5150MHz

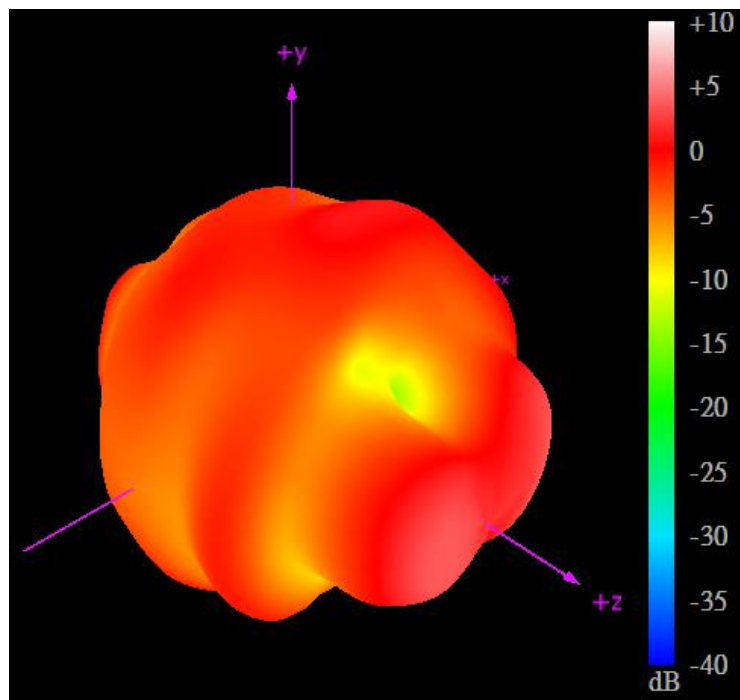

XZ Plane YZ Plane XY Plane

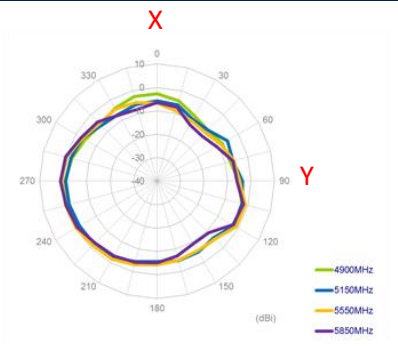
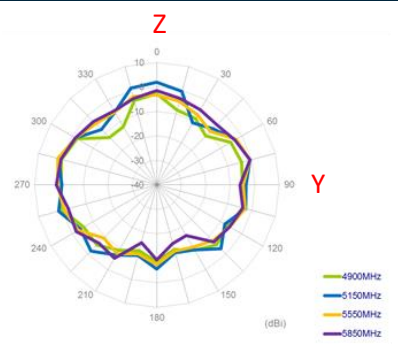
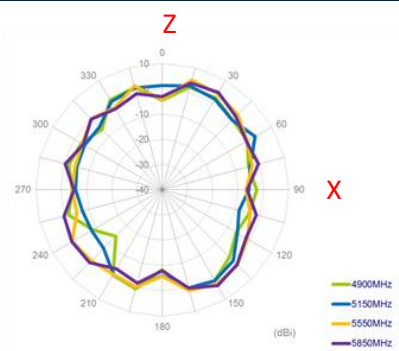

4.21 Free space (1m Cable) Patterns at 5850MHz

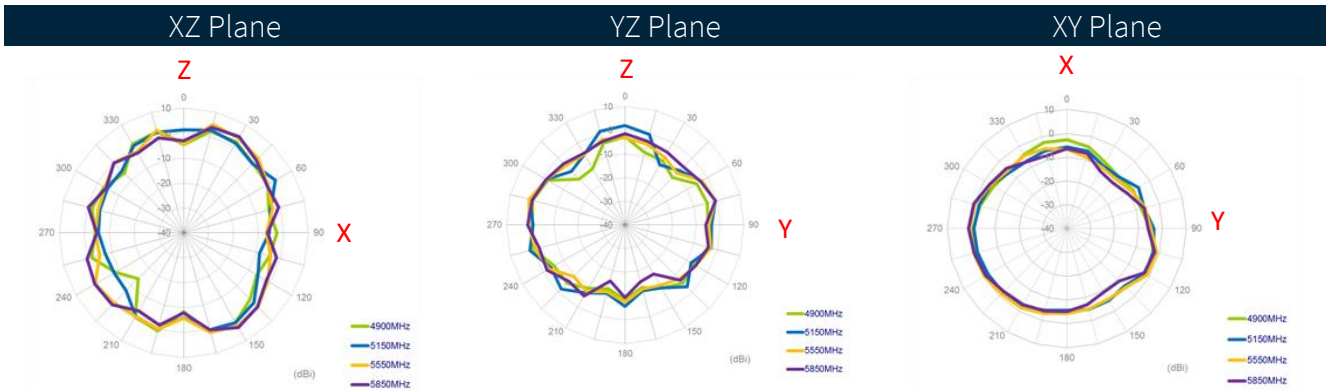
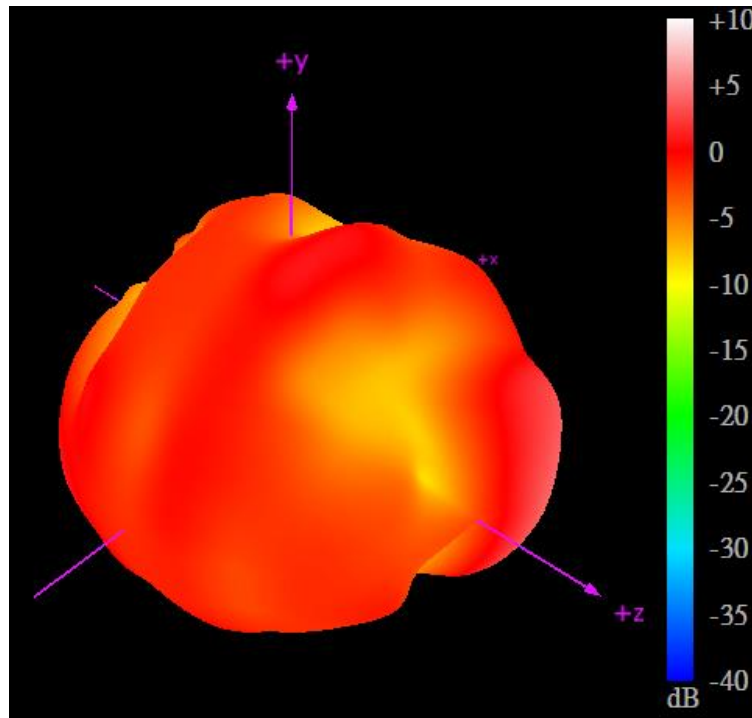

4.22 On Glass (1m Cable) Patterns at 450 MHz

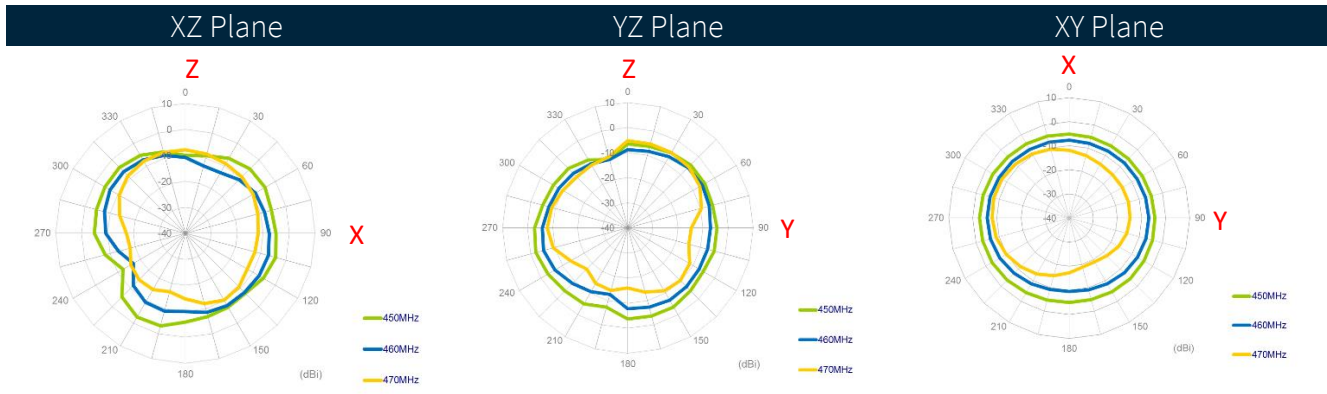
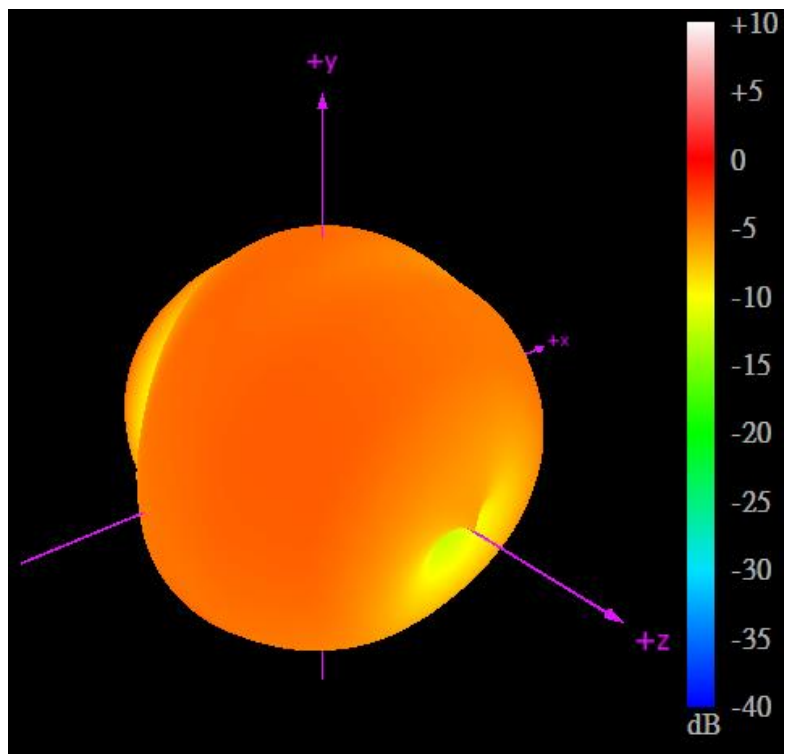

4.23 On Glass (1m Cable) Patterns at 470 MHz

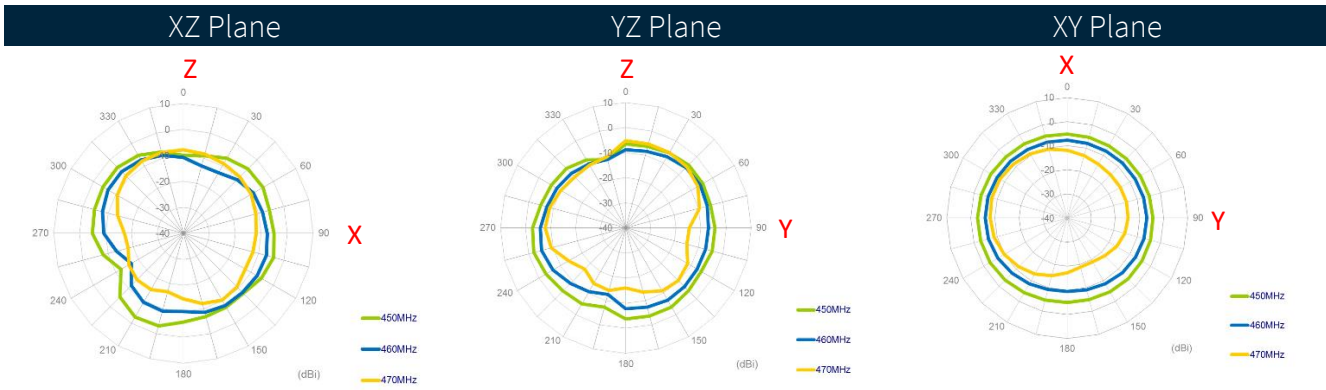
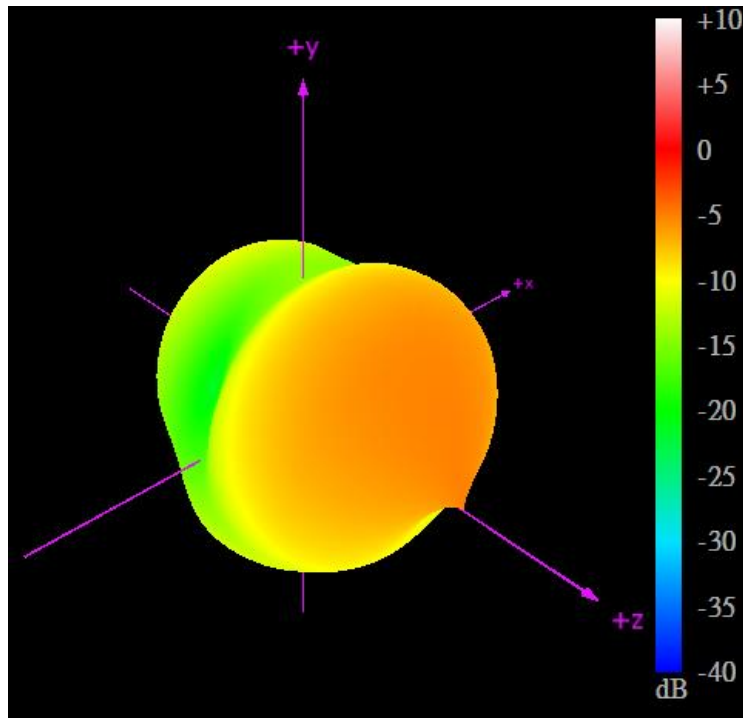



4.24 On Glass (1m Cable) Patterns at 704MHz

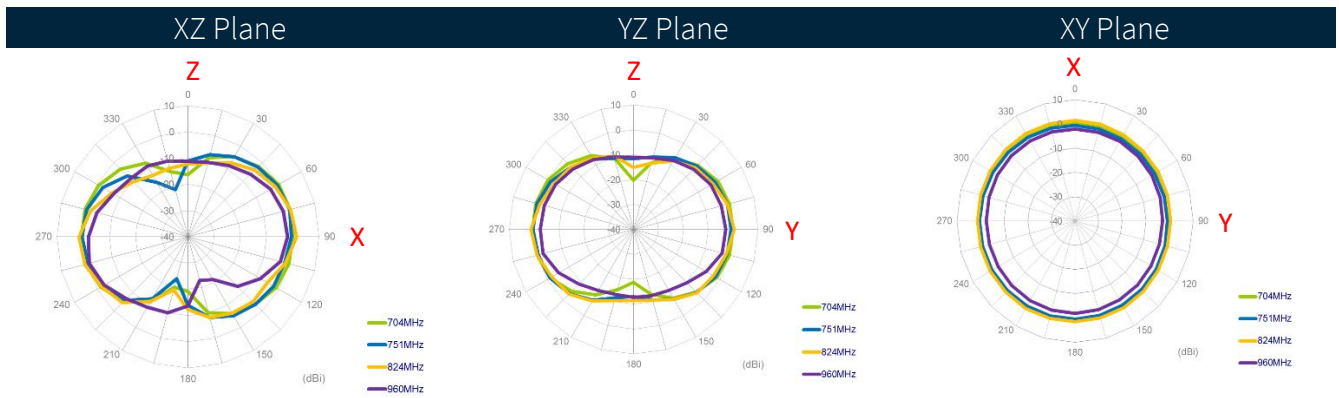
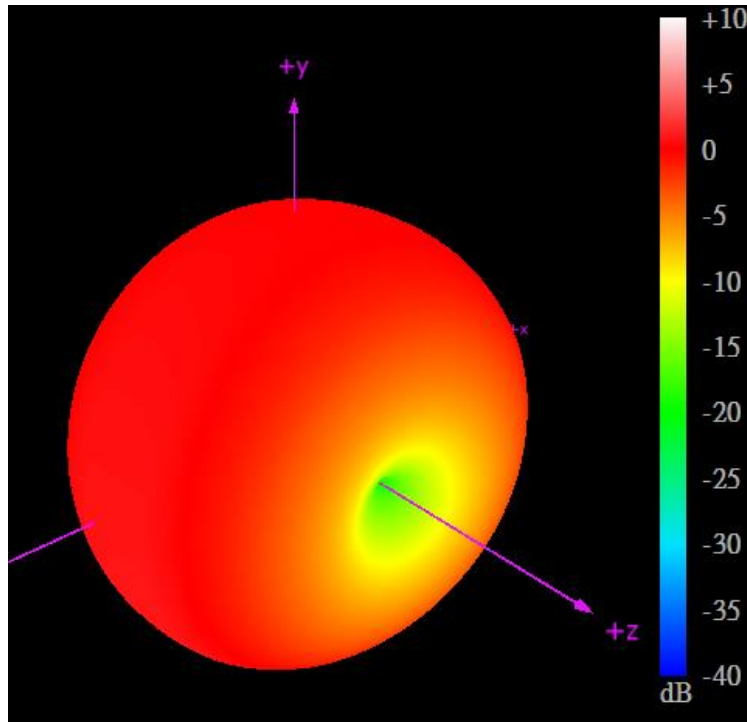

4.25 On Glass (1m Cable) Patterns at 960MHz

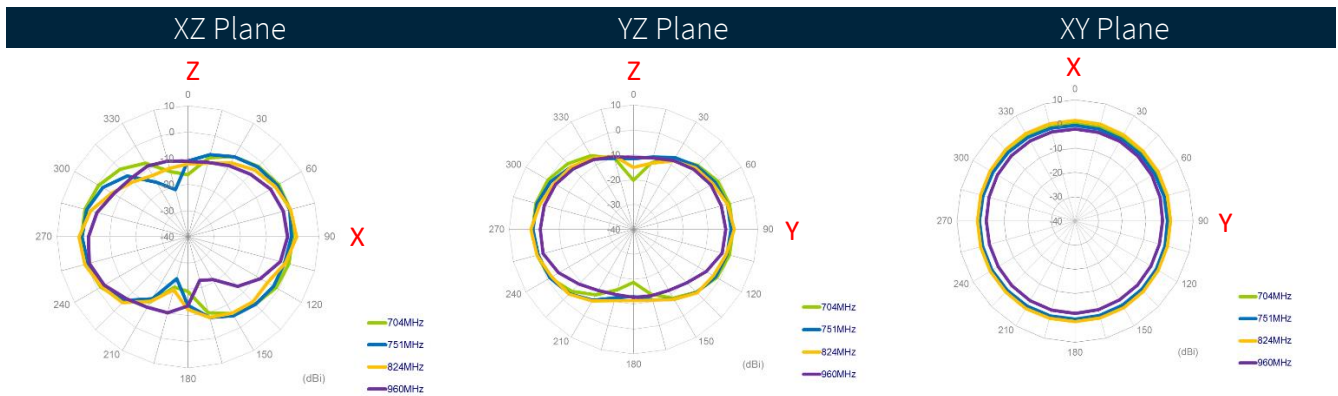
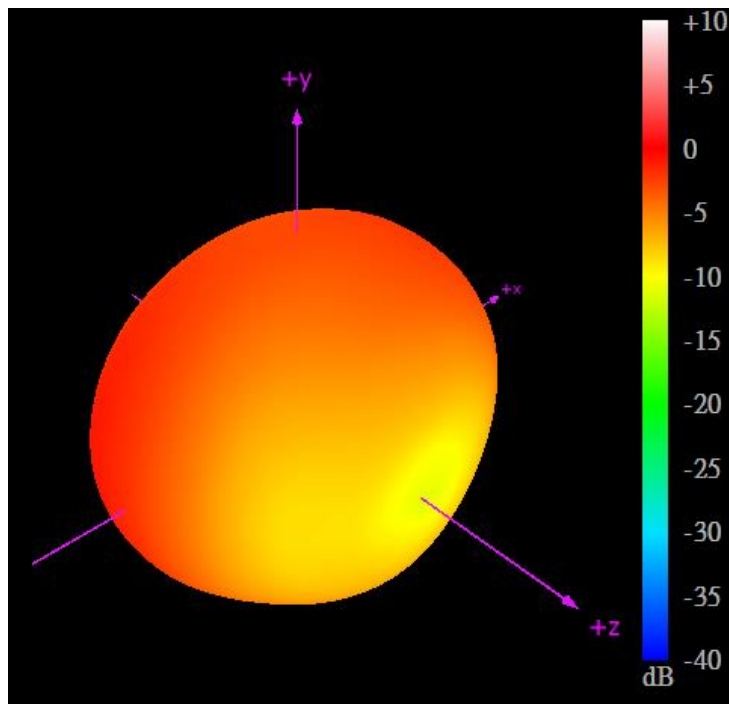

4.26 On Glass (1m Cable) Patterns at 1710MHz

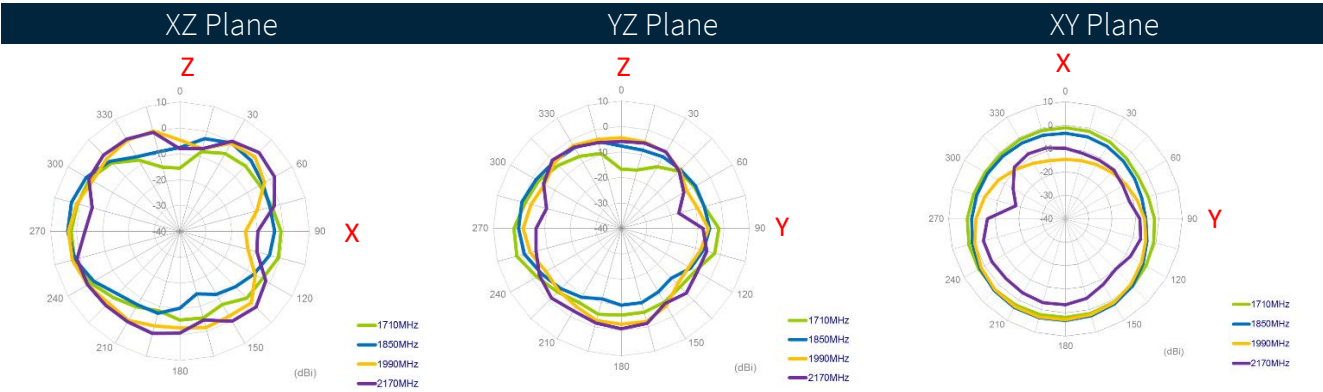
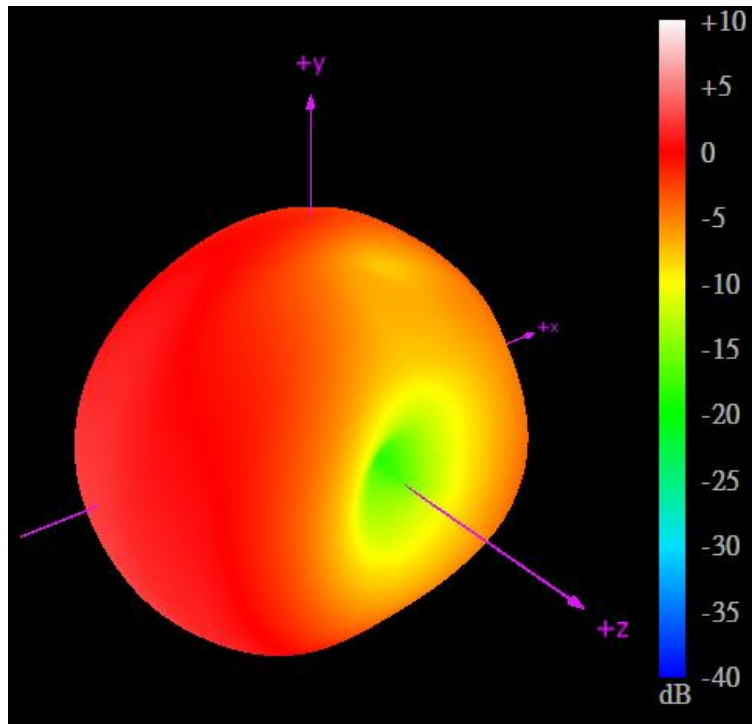

4.27 On Glass (1m Cable) Patterns at 2170MHz

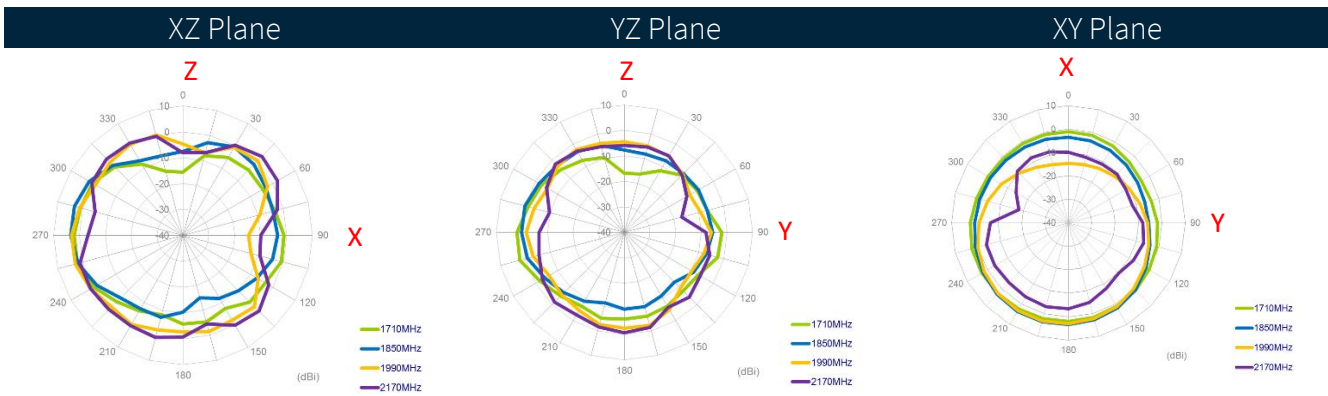
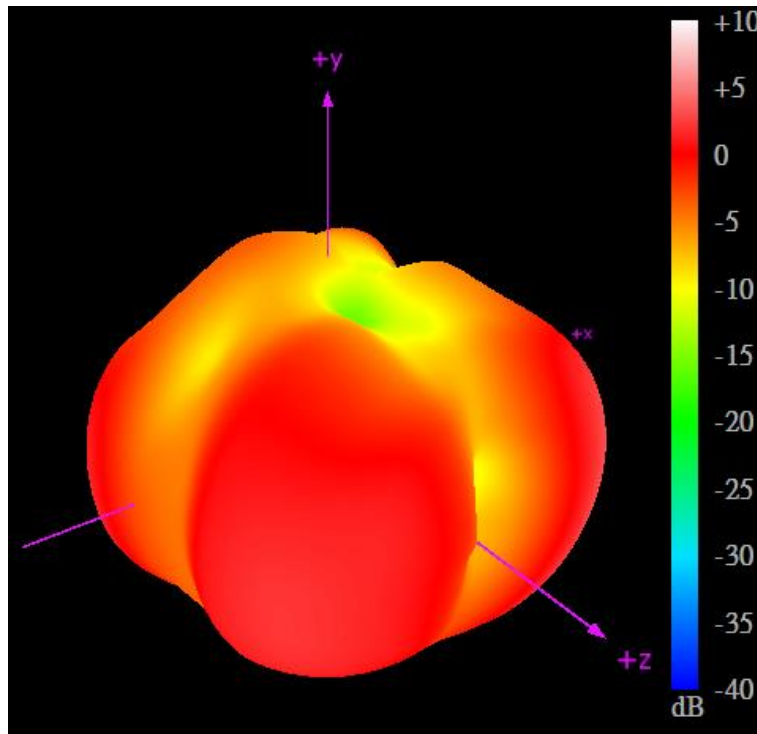

4.28 On Glass (1m Cable) Patterns at 2500MHz

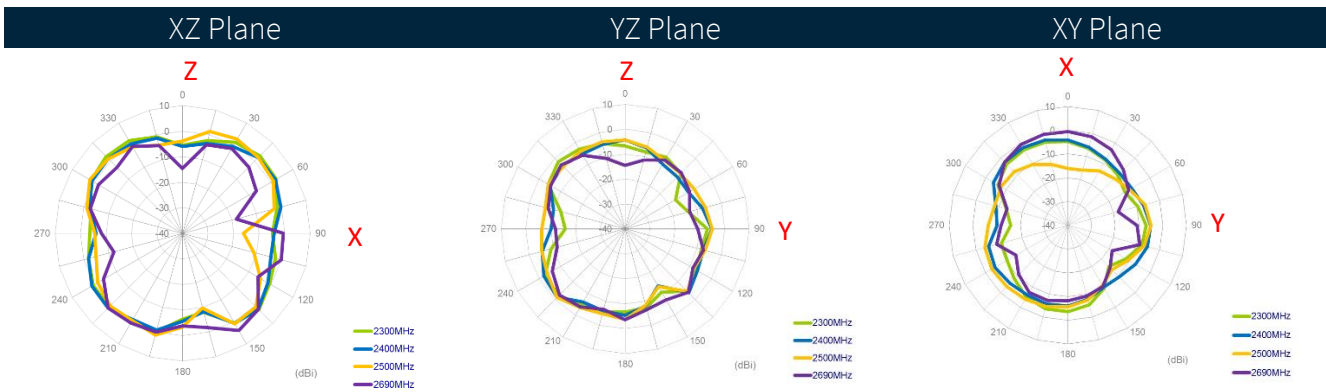
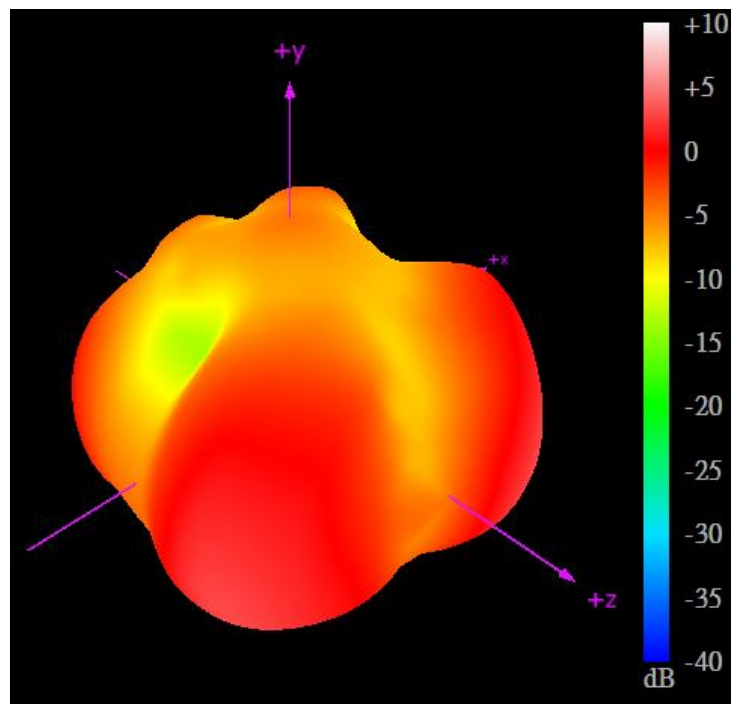

4.29 On Glass (1m Cable) Patterns at 2690MHz

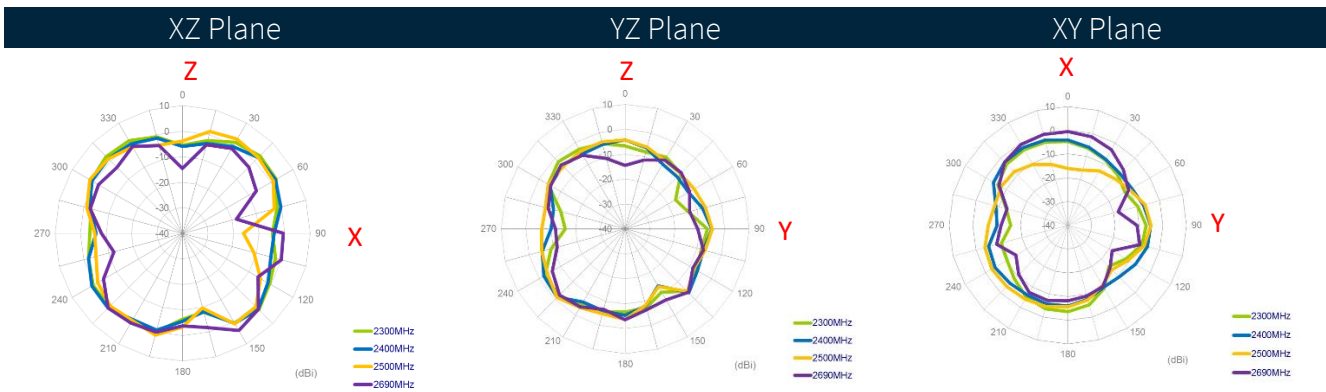
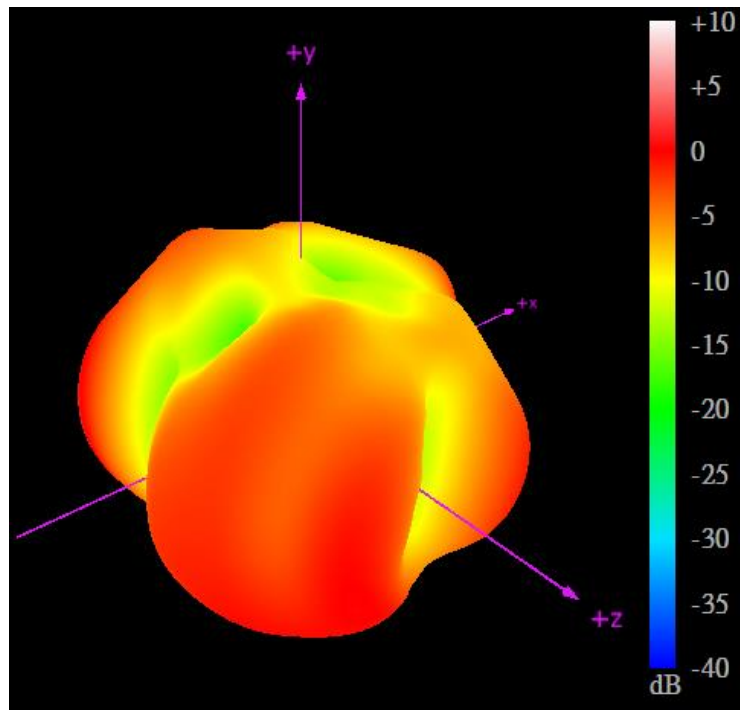

4.30 On Glass (1m Cable) Patterns at 5150MHz

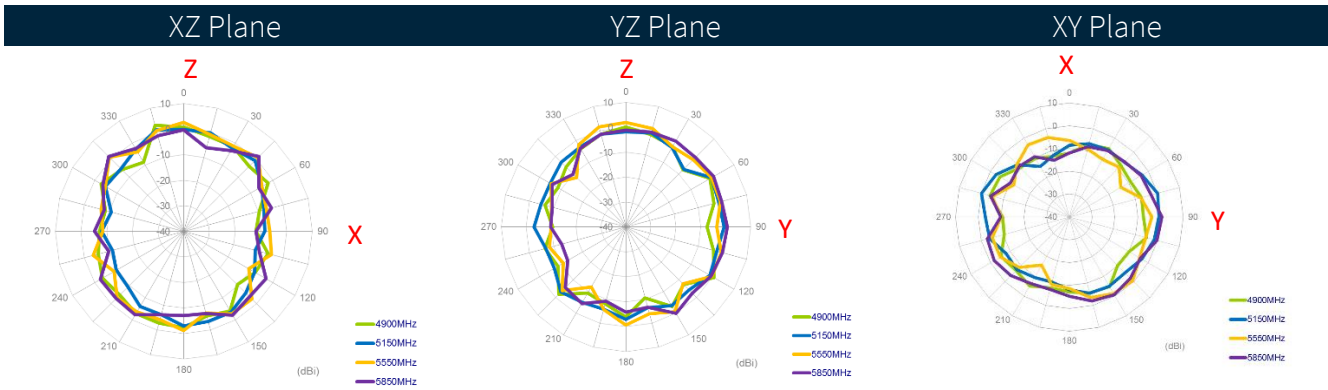
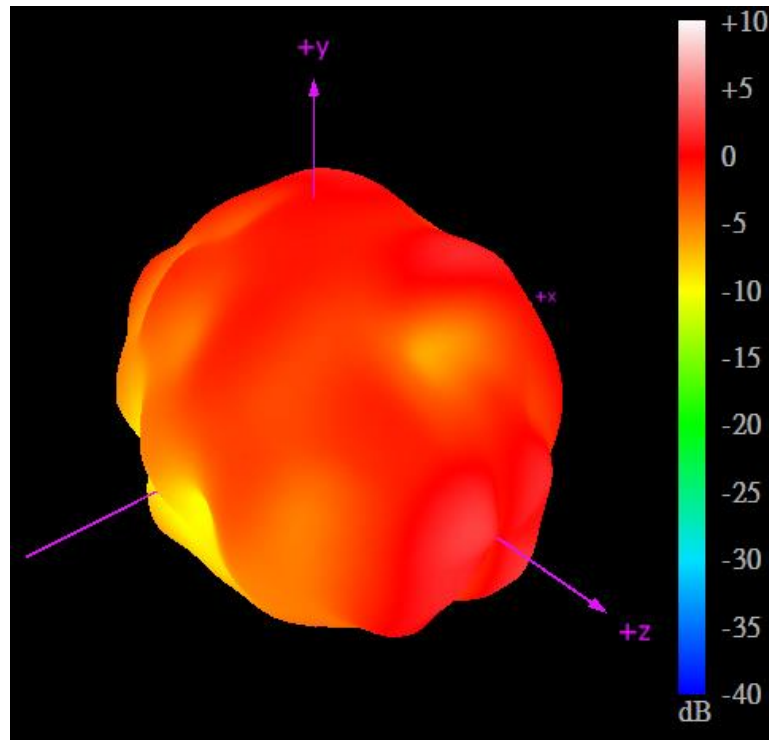

### 4.31 On Glass (1m Cable) Patterns at 5850MHz

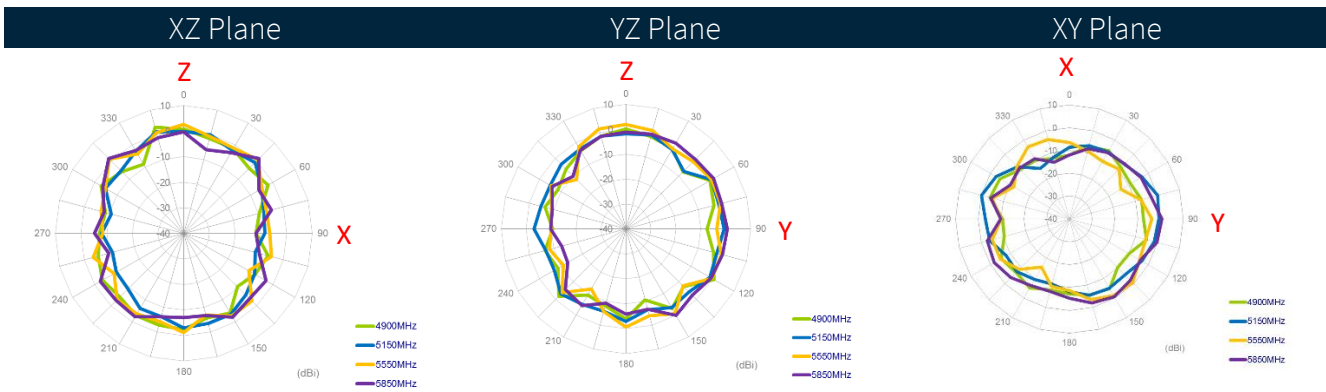
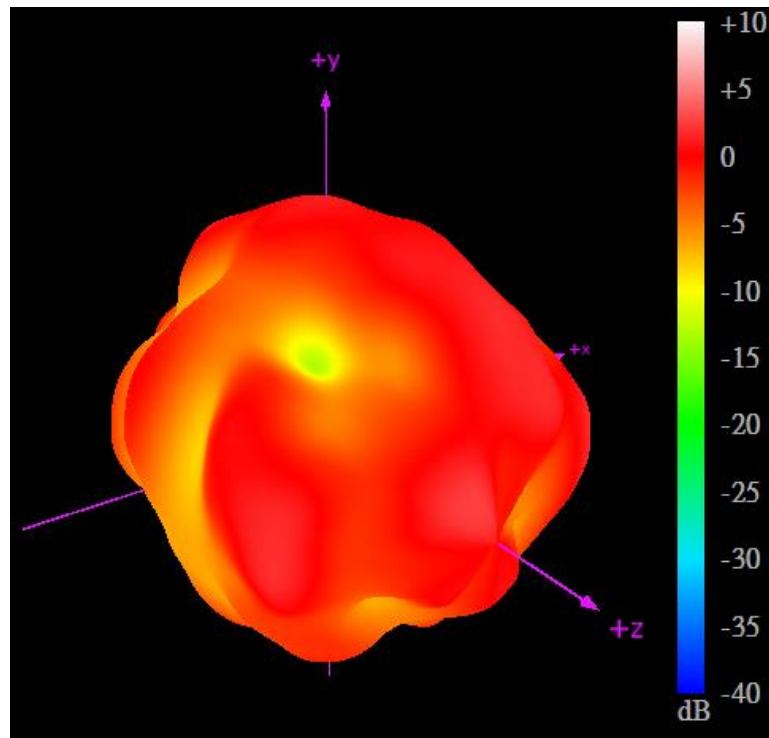



## 5. Mechanical Drawing

Top View

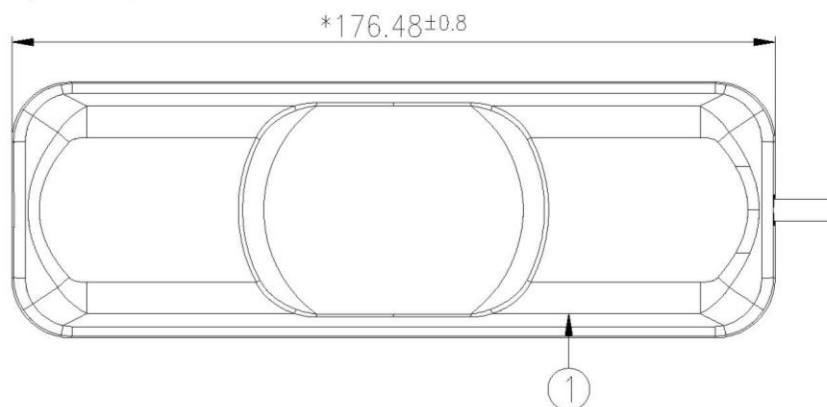

Side View

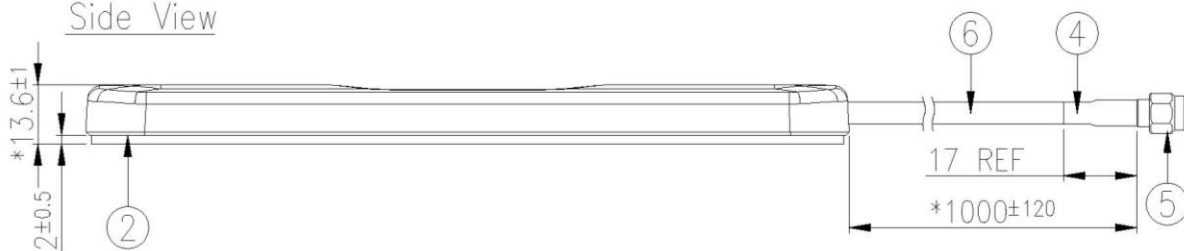

Bottom View



	Name	P/N	Material	Finish	QTY
1	Housing Top GSA8841	000113J020066A	ABS	Black	1
2	Housing Bottom GSA8841	000113J030066A	ABS	Black	1
3	Double Sided Adhesive With Foam(Black Foam)	001014C020039A	3M9448HK+CR4305	White Liner	1
4	Heat Shrink Tube	001315C030000A	PE	Black	1
5	SMA(M) ST	200216F020013A	Brass	Au Plated	1
6	TGC200 Coaxial Cable	306718E000000A	PE	Black	1

## 6. Packaging

1pc GSA.8846.A.105111 per PE bag  
 Bag Dimensions – 290\*160mm  
 Weight – 124g

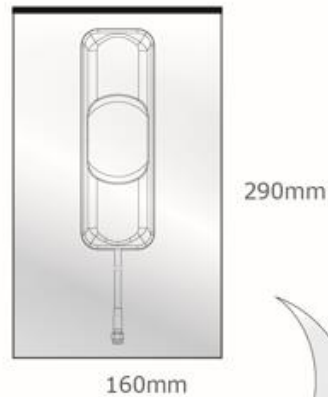

40pcs GSA.8846.A.105111 per carton  
 Carton Dimensions – 370\*370\*300mm  
 Weight – 6.4Kg

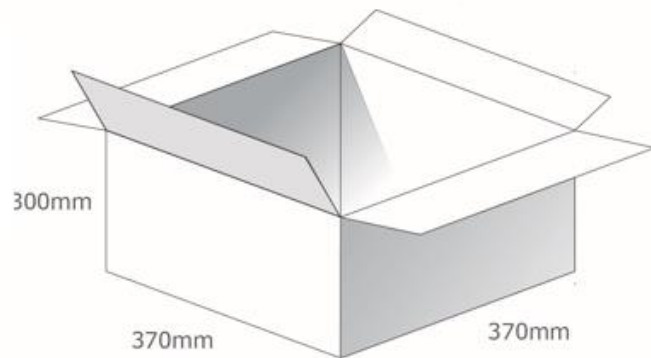

Pallet Dimensions – 1200\*1000\*1400mm  
 24 Cartons per pallet  
 6 Cartons per layer  
 4 Layers

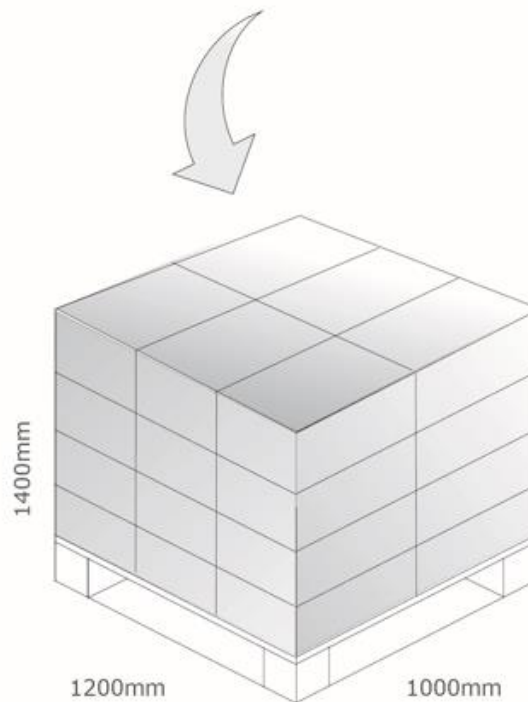

## 7. Application Note

The GSA.8845 antenna performance with different cable lengths and different mounting environments is shown below.

### 7.1 Return Loss – Free space

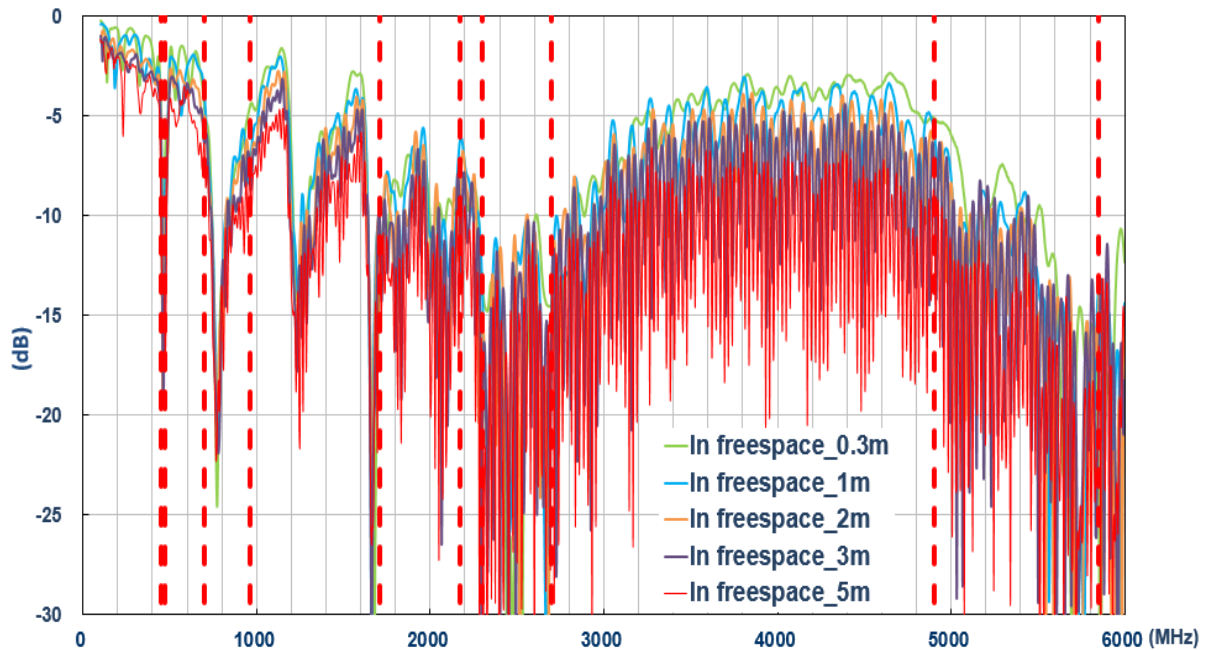

### 7.2 Efficiency – Free space



### 7.3 Average Gain – Free space

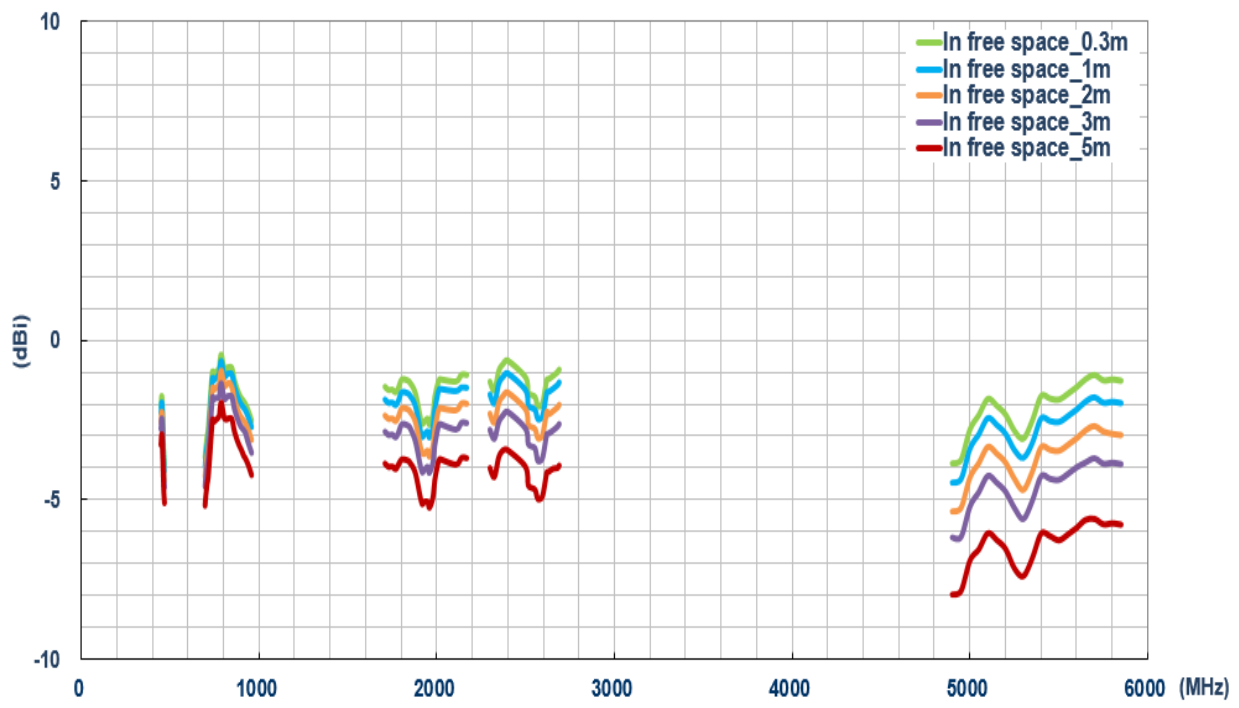

### 7.4 Peak Gain – Free space

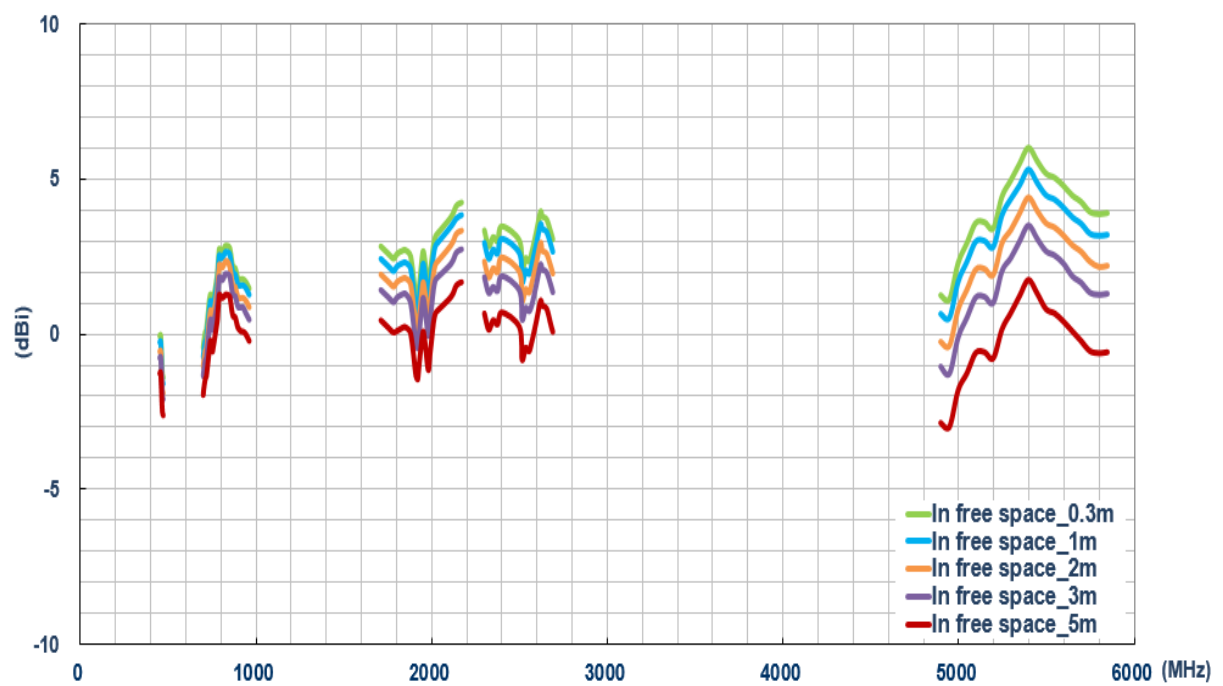

## 7.5 Return Loss – 2mm ABS

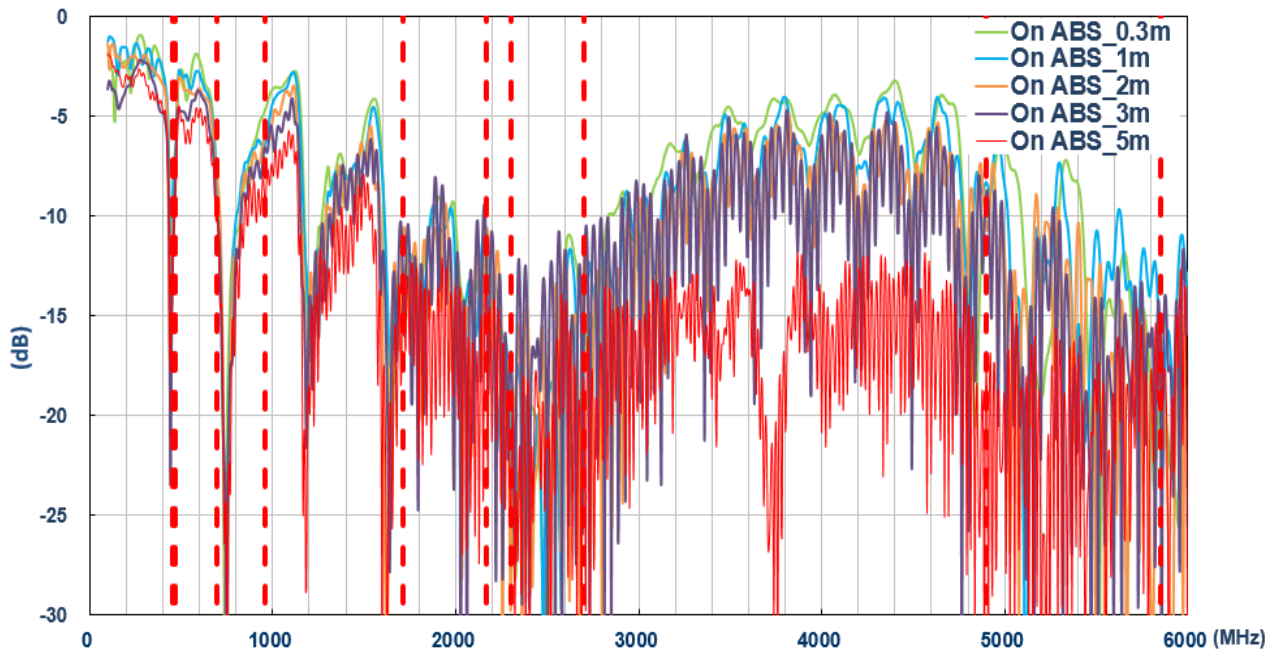

## 7.6 Efficiency – 2mm ABS

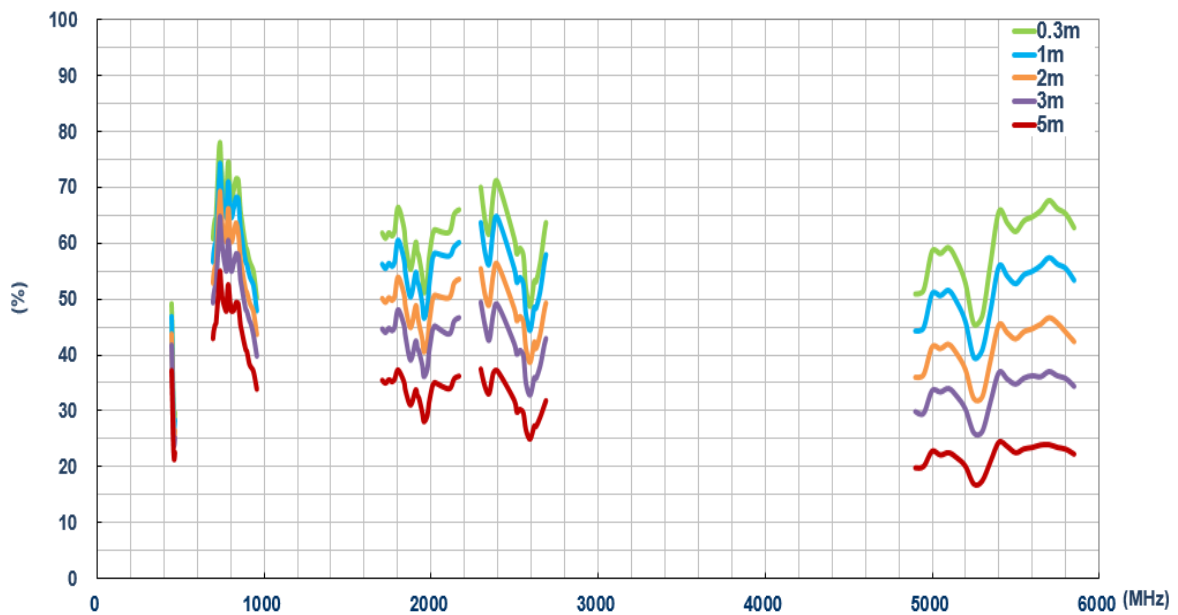

### 7.7 Average Gain – 2mm ABS

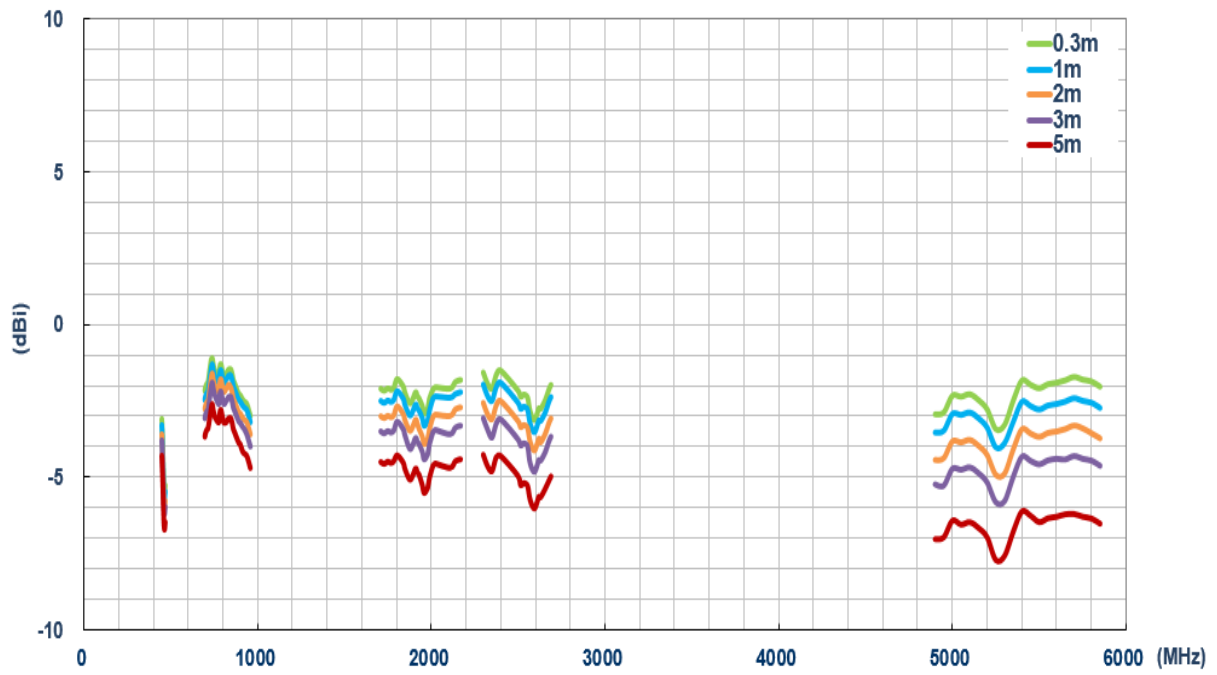

### 7.8 Peak Gain – 2mm ABS

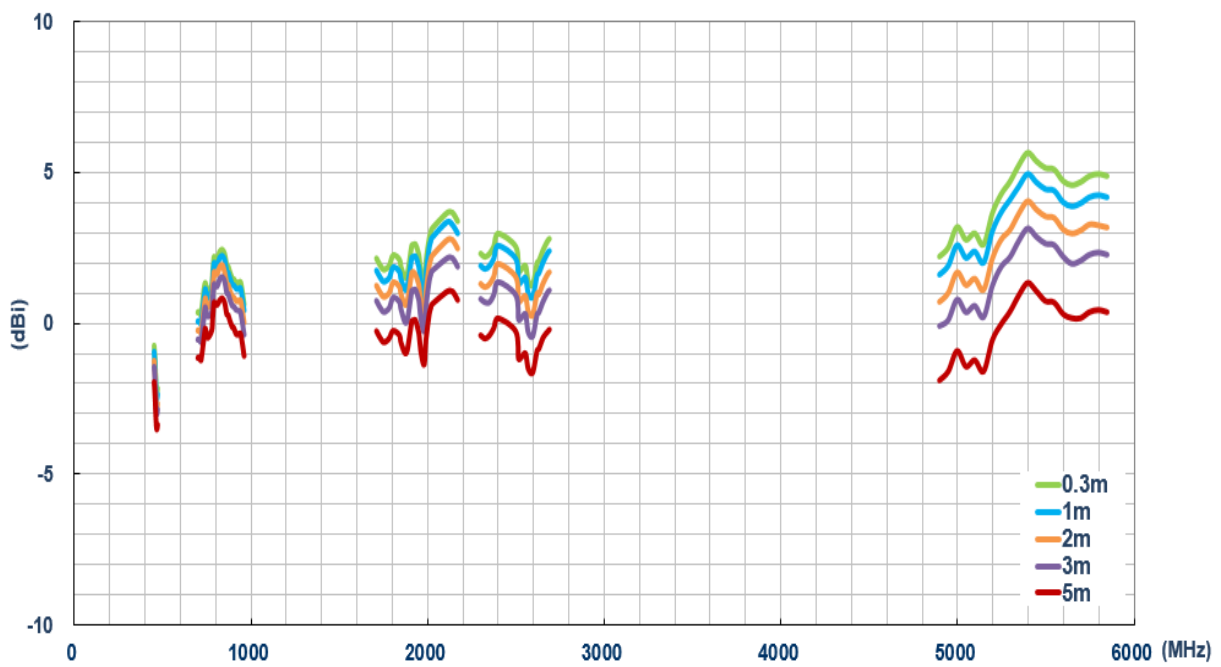

## 7.9 Return Loss – On Glass

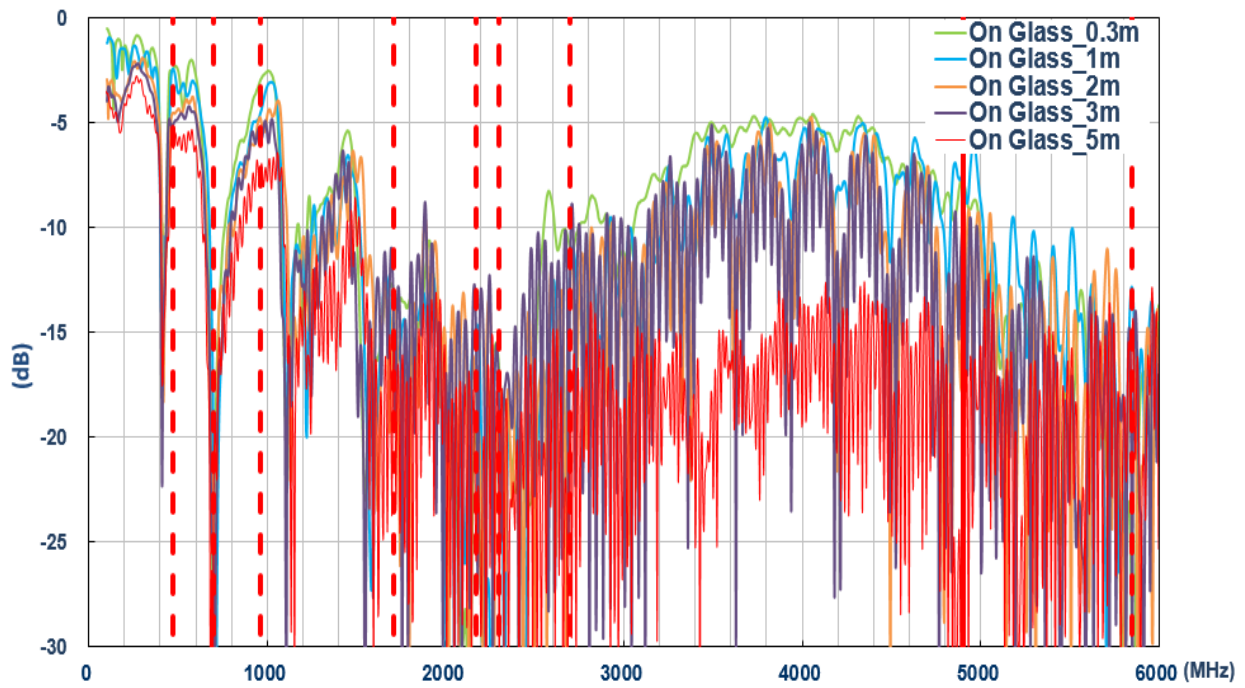

## 7.10 Efficiency – On Glass

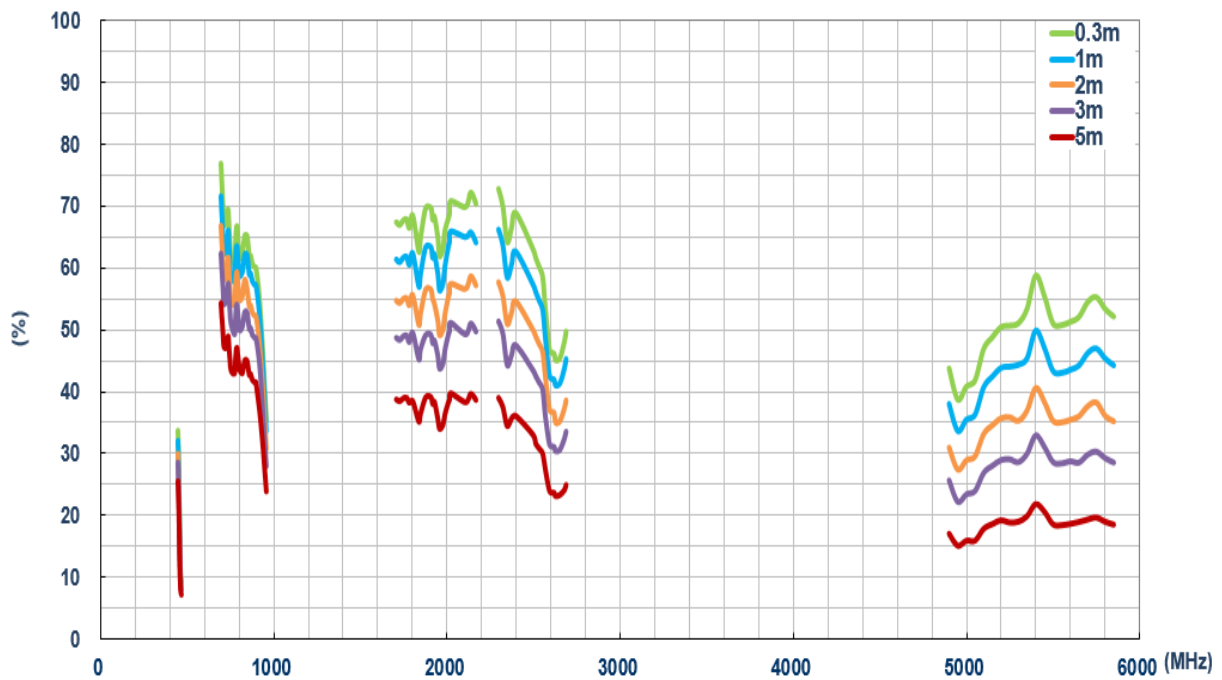

### 7.11 Average Gain – On Glass

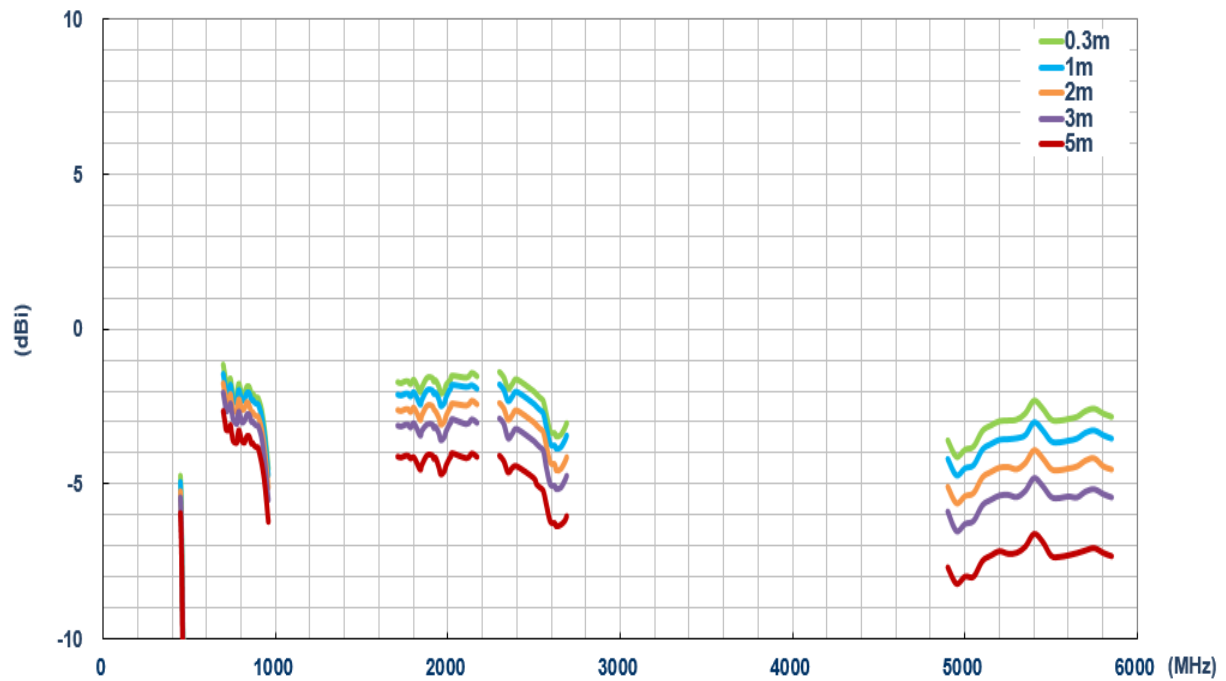

### 7.12 Peak Gain – On Glass

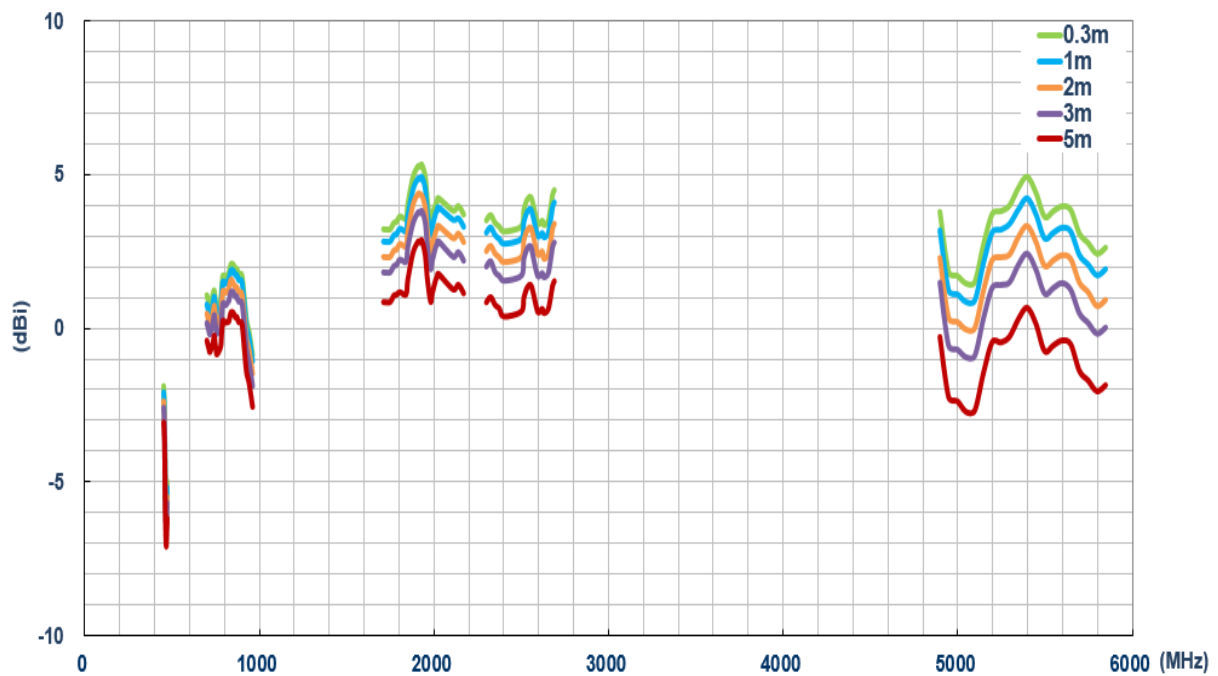



Changelog for the datasheet

SPE-24-8-003 – GSA.8846.A.105111

**Revision: A (Original First Release)**

Date:	2024-01-05
Notes:	Initial Release
Author:	Gary West

**Previous Revisions**



[www.taoglas.com](http://www.taoglas.com)

