



TAOGLAS®



Datasheet

MA114 2-in-1 Permanent Mount

Part No:
MA114.A.LB.001

Description:

2-in-1 GNSS and 4G Low Profile, Permanent Mount Combination Antenna with 0.3m cable and SMA(M) Connectors

Features:

2-in-1 low profile, Permanent mount combination antenna

1* GNSS GPS/GLONASS/BeiDou/Galileo

1* 4G/LTE 600-3000MHz

Ideal for mounting on enclosed metal devices

Cables: 0.3m RG-174 GNSS, 0.3m TGC-1.5DS 4G/LTE

Connectors: SMA(M)ST

Dimensions: Ø57*35mm

RoHS & Reach Compliant

1. Introduction	3
2. Specifications	4
3. Active Antenna Characteristics	8
4. 4G Antenna Characteristics	13
5. Radiation Patterns	15
6. Mechanical Drawing	21
7. Installation Instructions	22
8. Packaging	24
<hr/>	
Changelog	25

Taoglas makes no warranties based on the accuracy or completeness of the contents of this document and reserves the right to make changes to specifications and product descriptions at any time without notice. Taoglas reserves all rights to this document and the information contained herein. Reproduction, use or disclosure to third parties without express permission is strictly prohibited.



1. Introduction



The Taoglas MA114, is a small form factor 2-in-1 permanent mount combination antenna for use cases requiring worldwide 4G LTE coverage, from 600-3000MHz and GPS/GLONASS/BeiDou/Galileo for positioning. The MA114 has been designed to be mounted directly onto metal with no performance degradation. The MA114 covers fallback to 3G/2G bands where 4G coverage is not available and can also be used to cover Cat M1/LTE-M & NB-IoT bands.

Typical Applications include:

- Remote Monitoring
- Smart Metering
- Transportation

The IP67 waterproof PC / ABS enclosure measures just 35mm high and 57mm in diameter making it a superb choice for areas where space and heights constraints are present. The 4G LTE coaxial cable is low loss TGC-1.5DS with SMA(M) connectors and the GPS/GLONASS/BeiDou/Galileo cable is RG-174 and includes an SMA(M) connector.

The MA114 has been designed to be mounted on an enclosed metal box with no performance degradation and is perfect for metering and monitoring applications. The low profile robust enclosure makes it the ideal design and any industrial sector applications.

Customized cables and connector versions are also available. Contact your regional Taoglas customer support team for further information.

2. Specifications

GNSS Frequency Bands Covered							
GPS/QZSS	L1 1575.42MHz	L2 1227.6MHz	L5 1176.45MHz	L6 1278.75MHz			
	■	□	□	□			
GLONASS	L5R 1176.45MHz	L3PT 1201.5MHz	L2PT 1246MHz	L1CR 1575.42MHz	L1PT 1602MHz		
	□	□	□	■	■		
Galileo	E5a 1176.45MHz	E5b 1201.5MHz	E4 1215MHz	E3 1256MHz	E6 1278.75MHz	E2 1561MHz	L1 1575.42MHz
	□	□	□	□	□	■	■
BeiDou	B1 1561MHz	B2 1207.14MHz	B3 1268.52MHz				
	■	□	□				
Compass	E5B(B2)/ E6(B3) 1268.56MHz	E2(B1) 1561MHz					
	□	■					
SBAS	Omnistar 1542.5MHz	WAAS/EGN OS 1575.42MHz					
	□	■					

GNSS Electrical			
Frequency (MHz)	1561	1575.42	1602
VSWR (max.)	3.0:1	2.0:1	2.0:1
Passive Antenna Efficiency (%)	42.6	56.89	61.9
Passive Antenna Gain at Zenith (dBic)	1.08	2.11	2.08
Axial Ratio (dB)	13	9	3
Polarization	RHCP		
Impedance	50Ω		
Cable	300mm RG-174		
Connector	SMA(M)		

LNA and Filter Electrical Properties			
Frequency (MHz)	1561	1575.42	1602
VSWR (max.)	2.0:1	2.0:1	2.0:1
Gain@1.8V (Typ.)	28.8	28.8	28.0
Gain@3.0V (Typ.)	29.1	29.0	28.3
Gain@5.5V (Typ.)	29.6	29.3	28.7
Noise@1.8V (Typ.)	2.7	2.2	2.7
Noise@3.0V (Typ.)	2.7	2.2	2.6
Noise@5.5V (Typ.)	2.8	2.2	2.7
Power consumption@1.8V (Typ.)	8.6		
Power consumption@3.0V (Typ.)	8.9		
Power consumption@5.5V (Typ.)	10.5		
Total Specification (Through Antenna, SAW Filter and LNA)			
Frequency (MHz)	1561	1575.42	1602
Gain@3V (dBi)	28	28	28
Noise@3V (dB)	3	3	3
Output Impedance	50 Ω		

4G LTE Electrical

Band	Frequency (MHz)	Efficiency (%)	Average Gain (dB)	Peak Gain (dBi)
4G/3G Band 12,13,14,17,28,29	698~806	37	-4.3	0.7
4G/3G/NB-IoT/Cat M Band 5,8,18,19,20,26,27	824~960	19	-7.4	-2.2
4G/3G Band 1,2,3,4,9,23,25,35,39,66	1710~2200	62	-2.1	4.1
4G/3G Band 7,38,41	2490~2690	51	-2.9	4.2

Mechanical

Height	35mm
Planner Dimension	Ø57mm
Casing	PC+ABS
Cable	0.3m RG174 for LTE – Fully Customizable 0.3m RG174 for GNSS – Fully Customizable
Connector	LTE: SMA-Plug – Fully Customizable GNSS: SMA-Plug – Fully Customizable
Weight	90g (Not Including Packaging)
Environmental	
Temperature Range	-40°C to 85°C
Humidity	Non-condensing 65°C 95% RH
Cable Pull Force	RG174 - 4 Kgf

5G/4G Bands			
Band Number	5G NR / FR1 / LTE / LTE-Advanced / WCDMA / HSPA / HSPA+ / TD-SCDMA / Cat M / NB-IoT		
	Uplink	Downlink	Covered
1	UL: 1920 to 1980	DL: 2110 to 2170	✓
2	UL: 1850 to 1910	DL: 1930 to 1990	✓
3	UL: 1710 to 1785	DL: 1805 to 1880	✓
4	UL: 1710 to 1755	DL: 2110 to 2155	✓
5	UL: 824 to 849	DL: 869 to 894	✓
7	UL: 2500 to 2570	DL: 2620 to 2690	✓
8	UL: 880 to 915	DL: 925 to 960	✓
9	UL: 1749.9 to 1784.9	DL: 1844.9 to 1879.9	✓
11	UL: 1427.9 to 1447.9	DL: 1475.9 to 1495.9	✗
12	UL: 699 to 716	DL: 729 to 746	✓
13	UL: 777 to 787	DL: 746 to 756	✓
14	UL: 788 to 798	DL: 758 to 768	✓
17	UL: 704 to 716	DL: 734 to 746	✓
18	UL: 815 to 830	DL: 860 to 875	✓
19	UL: 830 to 845	DL: 875 to 890	✓
20	UL: 832 to 862	DL: 791 to 821	✓
21	UL: 1447.9 to 1462.9	DL: 1495.9 to 1510.9	✓
22	UL: 3410 to 3490	DL: 3510 to 3590	✗
23	UL: 2000 to 2020	DL: 2180 to 2200	✓
24	UL: 1625.5 to 1660.5	DL: 1525 to 1559	✓
25	UL: 1850 to 1915	DL: 1930 to 1995	✓
26	UL: 814 to 849	DL: 859 to 894	✓
27	UL: 807 to 824	DL: 852 to 869	✓
28	UL: 703 to 748	DL: 758 to 803	✓
29	UL: -	DL: 717 to 728	✓
30	UL: 2305 to 2315	DL: 2350 to 2360	✓
31	UL: 452.5 to 457.5	DL: 462.5 to 467.5	✗
32	UL: -	DL: 1452 - 1496	✓
35		1850 to 1910	✓
38		2570 to 2620	✓
39		1880 to 1920	✓
40		2300 to 2400	✓
41		2496 to 2690	✓
42		3400 to 3600	✗
43		3600 to 3800	✗
48		3550 to 3700	✗
66	UL: 1710-1780	DL: 2110-2200	✓
71		617 to 698	✓
74/75/76		1427 to 1518	✓
77		3300 to 4200	✗
78		3300 to 3800	✗
79		4400 to 5000	✗

3. Active Antenna Characteristics

3.1 Block Diagram

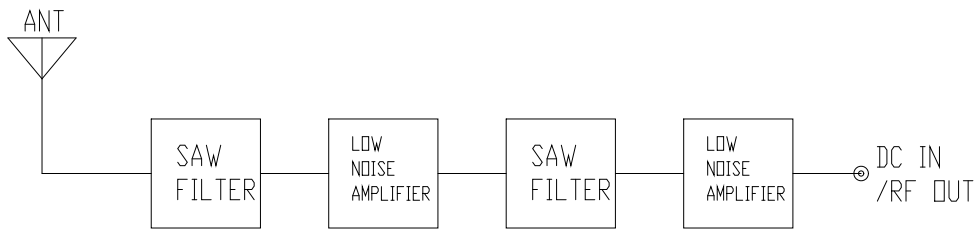

3.2 Passive Antenna Return Loss

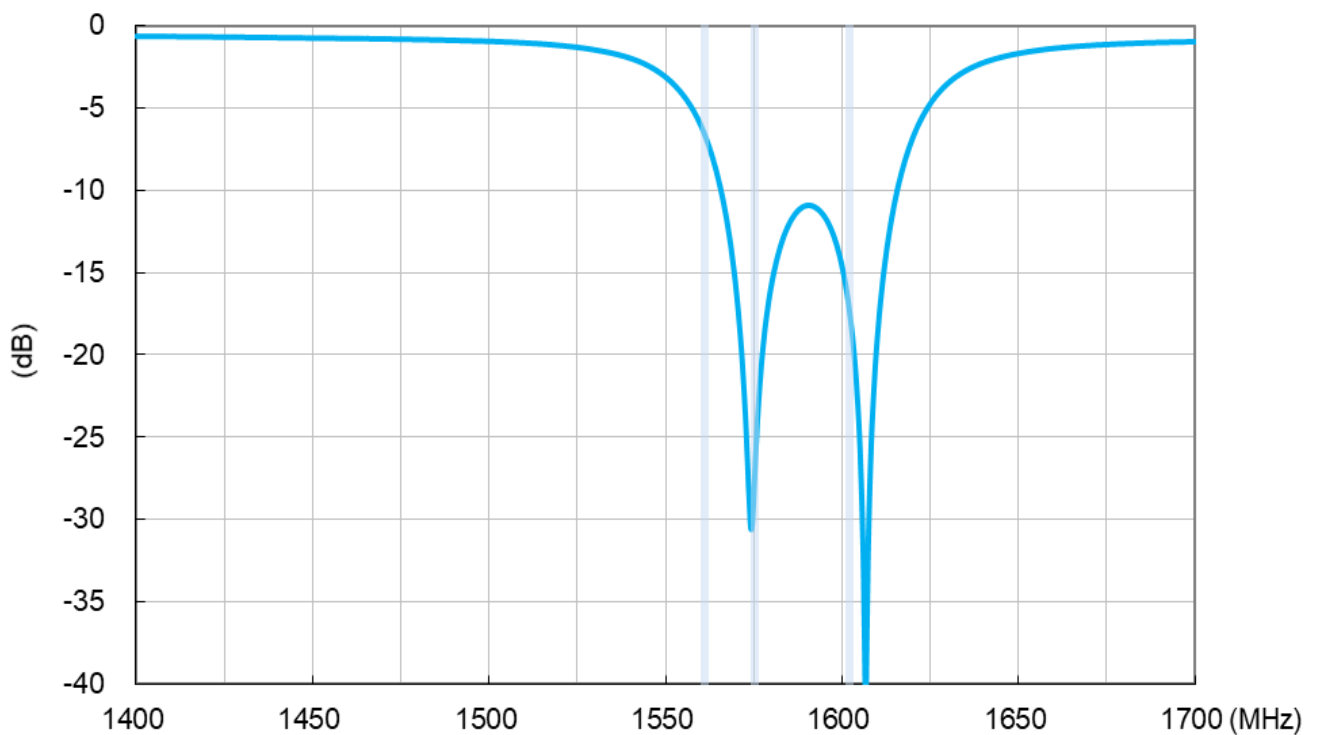

3.3 Passive Antenna Efficiency

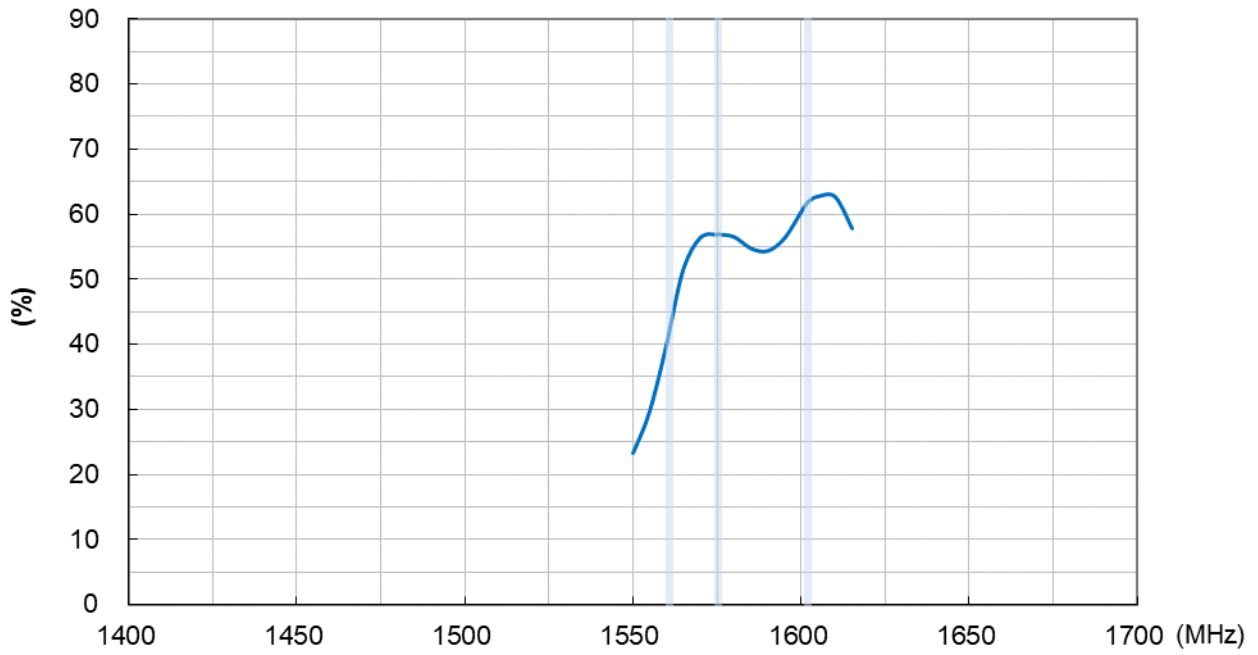

3.4 Passive Antenna Average Gain

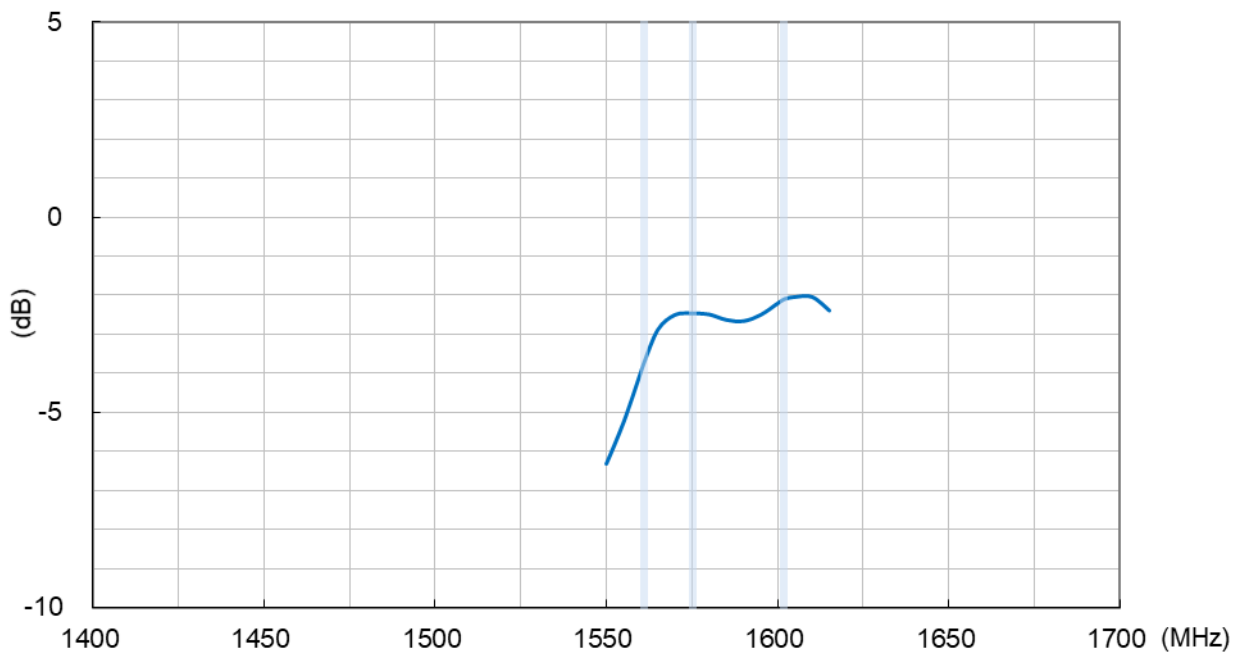

3.5 Passive Antenna Peak Gain

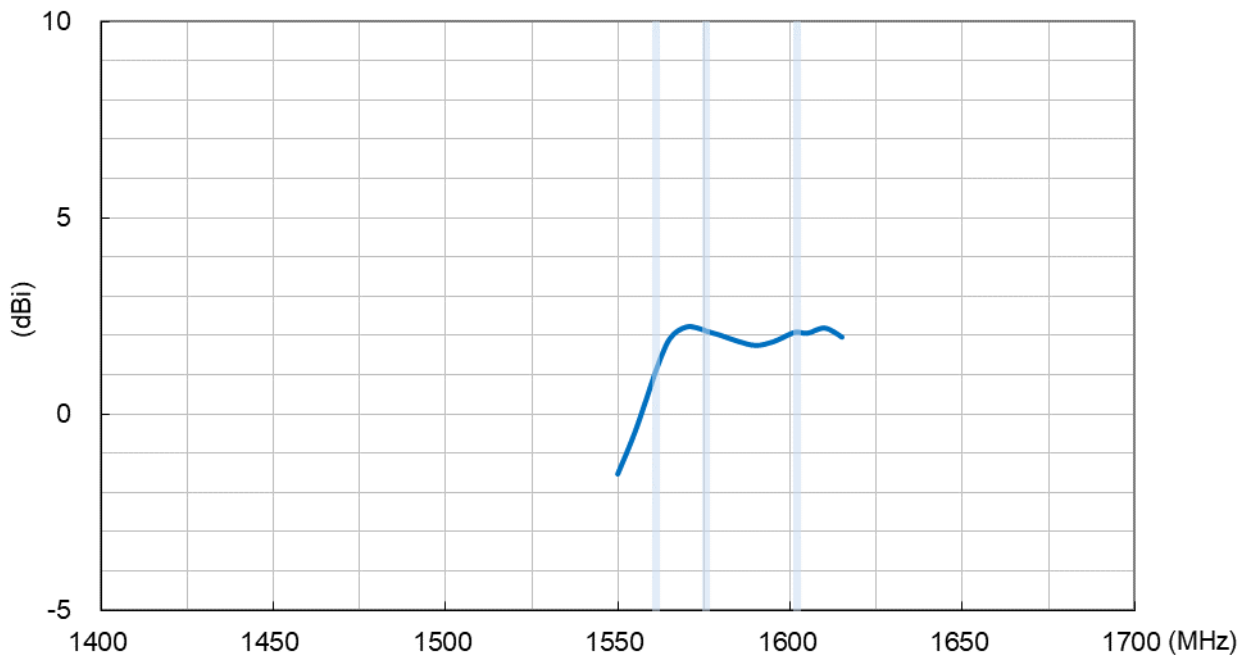

3.6 Passive Antenna Axial Ratio (Zenith is at 0°)

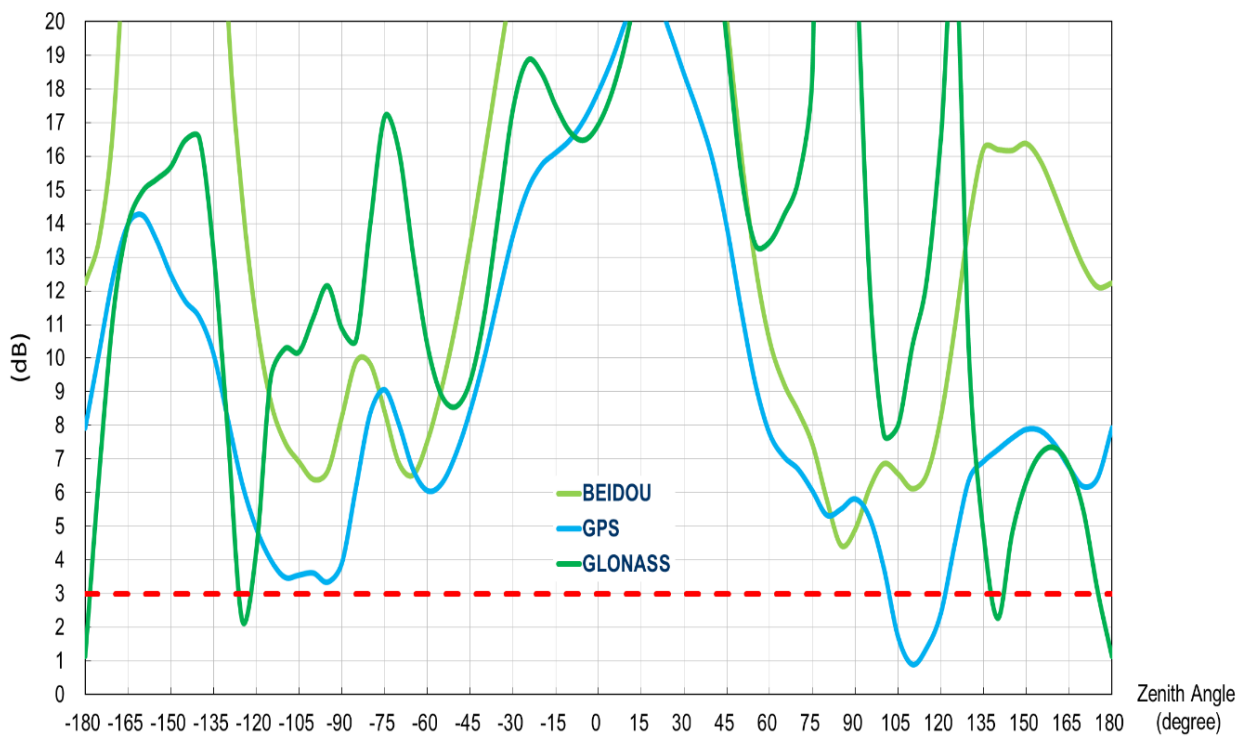

3.7 Active Measurements

LNA Gain @3.0V

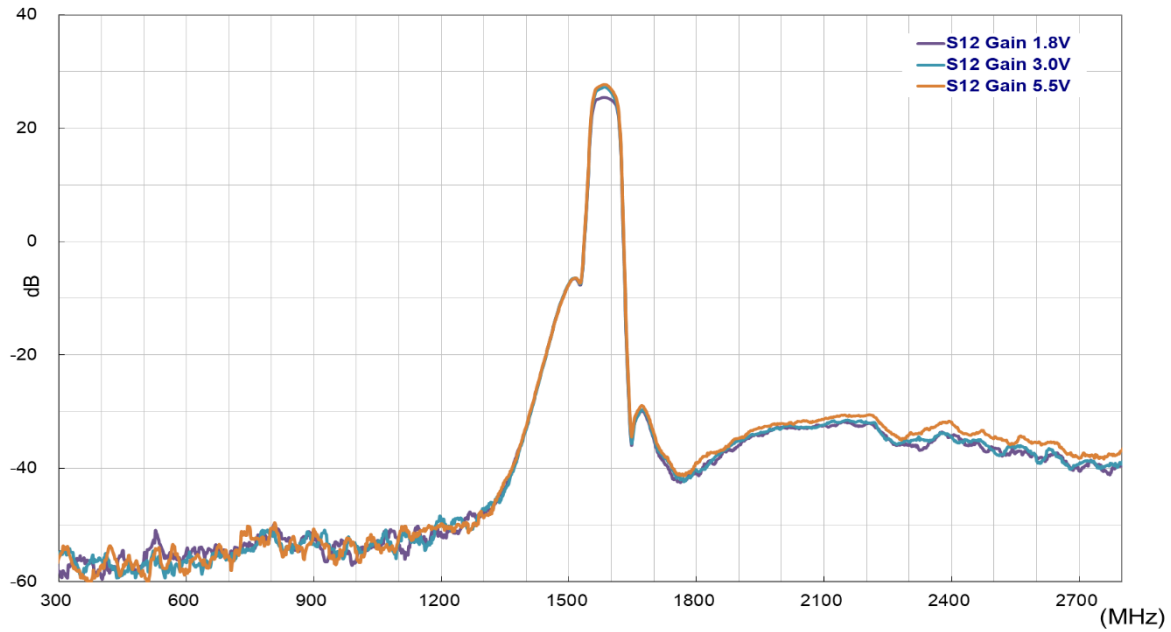

3.8 Passive Antenna Axial Ratio (Zenith is at 0°)

Noise Figure @ 3.0V

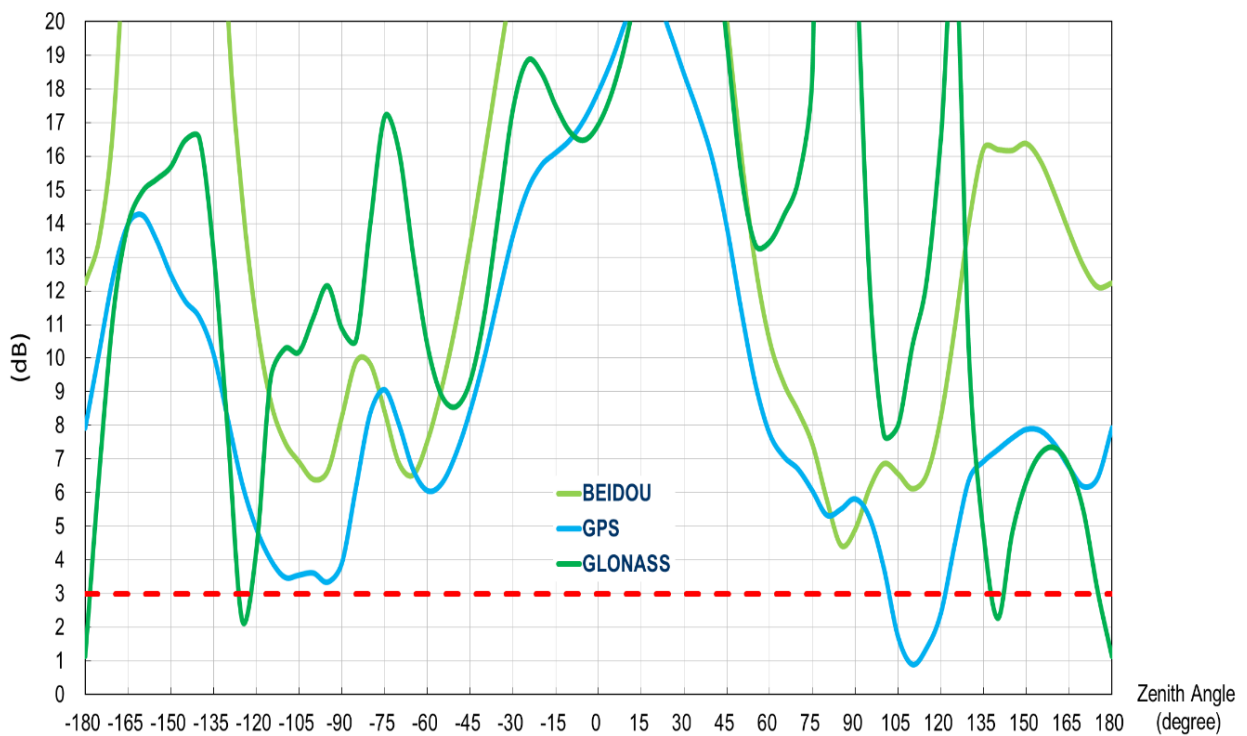

3.9 GNSS 3D and 2D Radiation Patterns

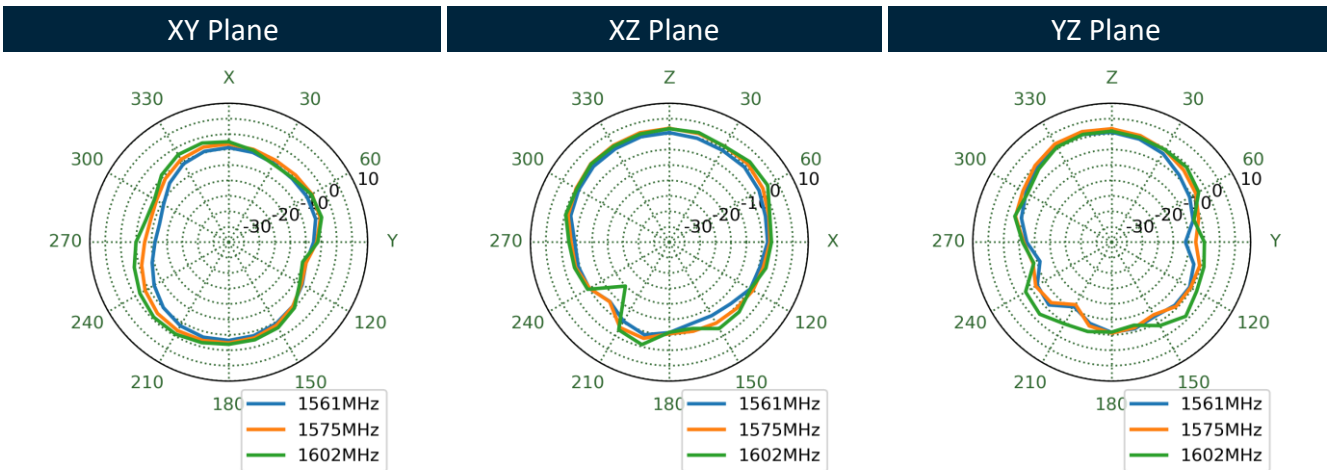
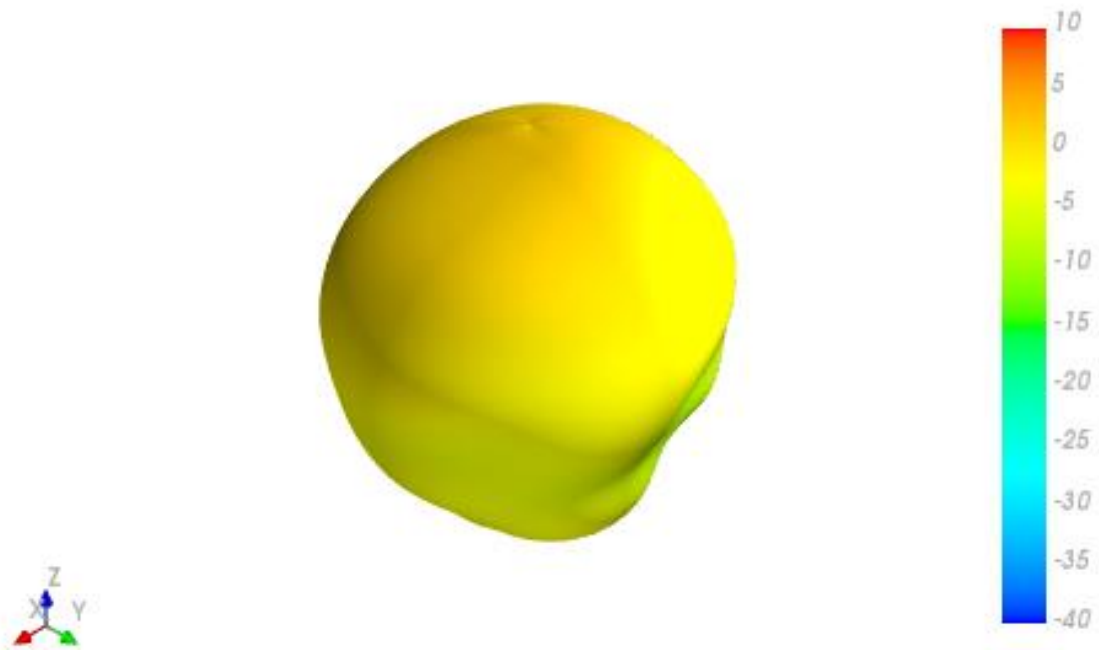

4. 4G Antenna Characteristics

4.1 Return Loss

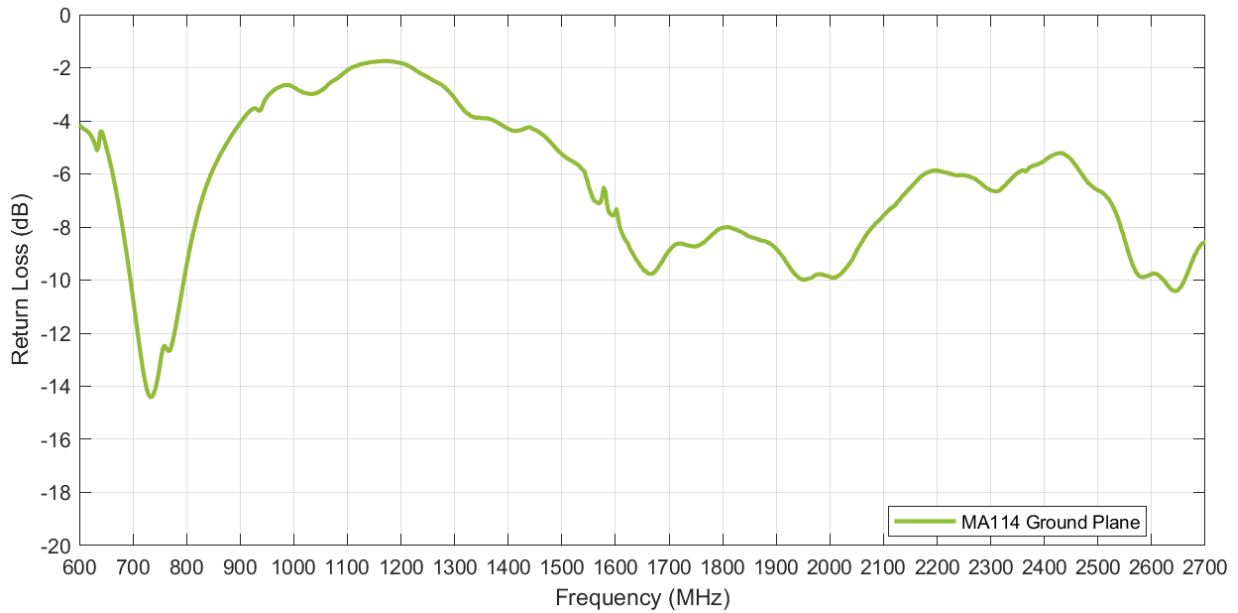

4.3 Efficiency

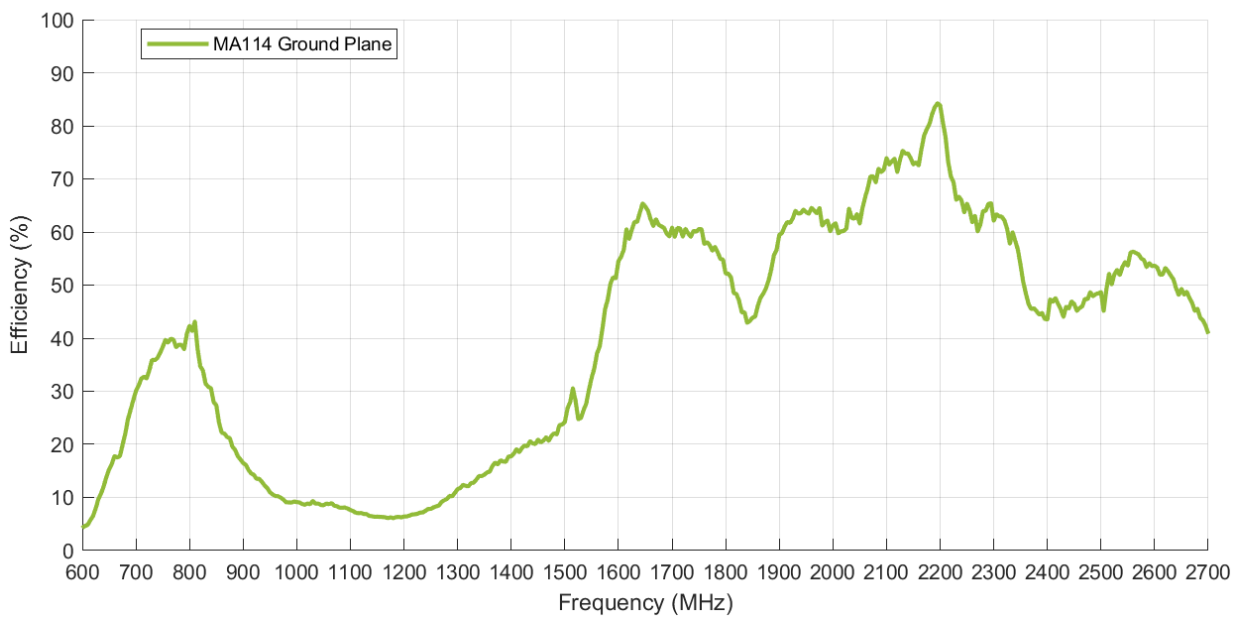

4.4 Average Gain

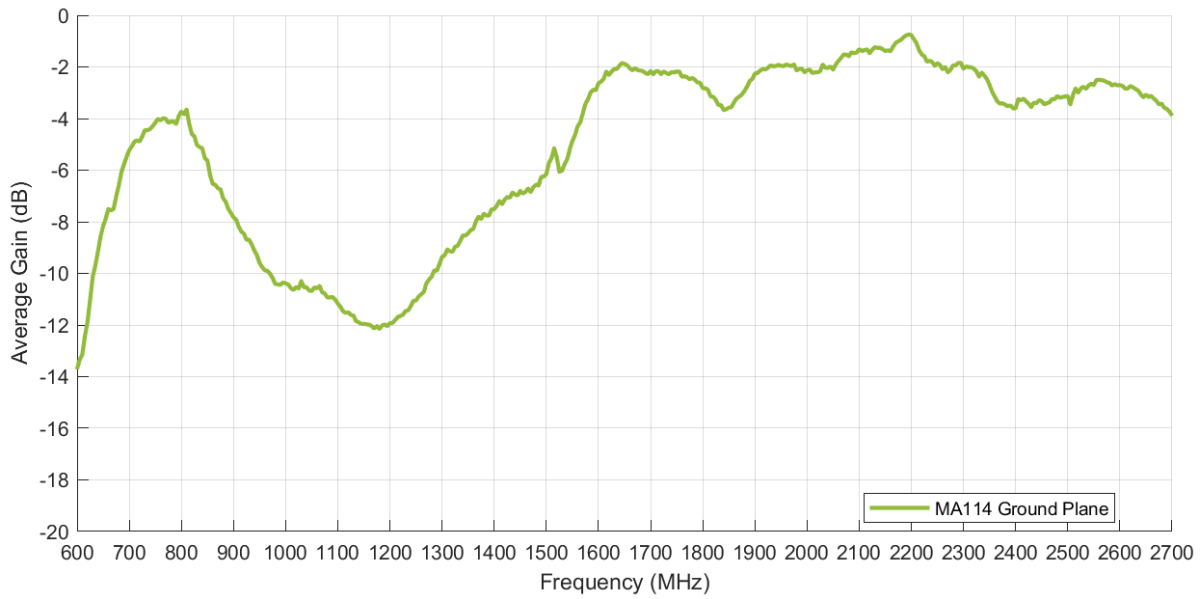

4.5 Peak Gain

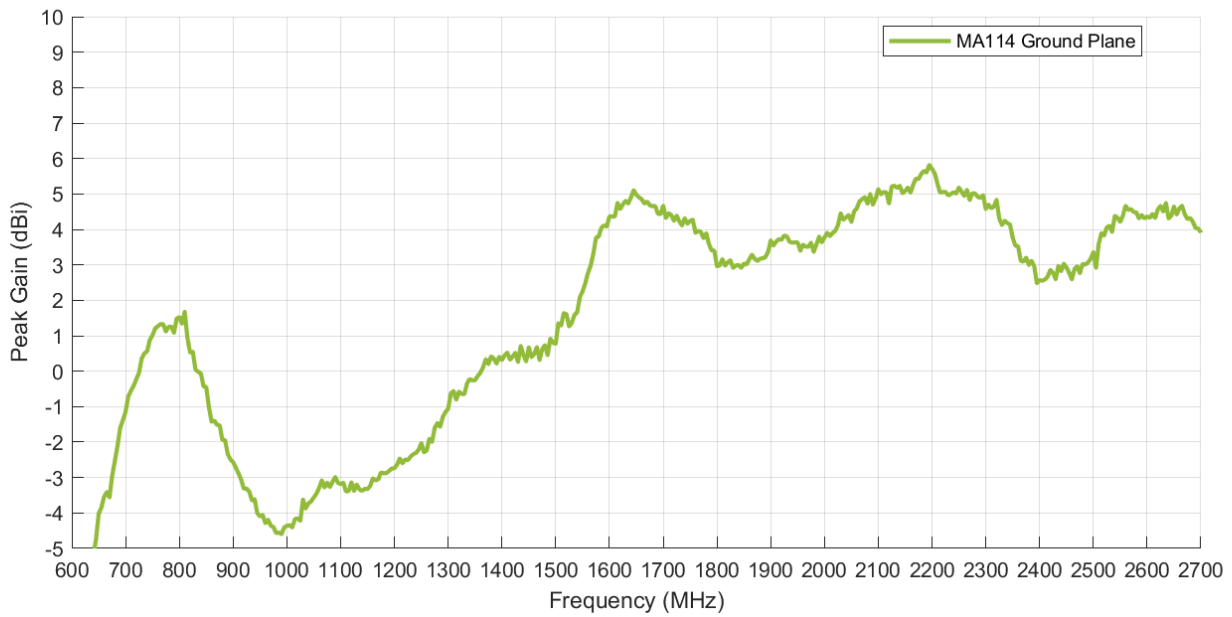

5. Radiation Patterns

5.1 4G - 3D and 2D Radiation Patterns

750MHz

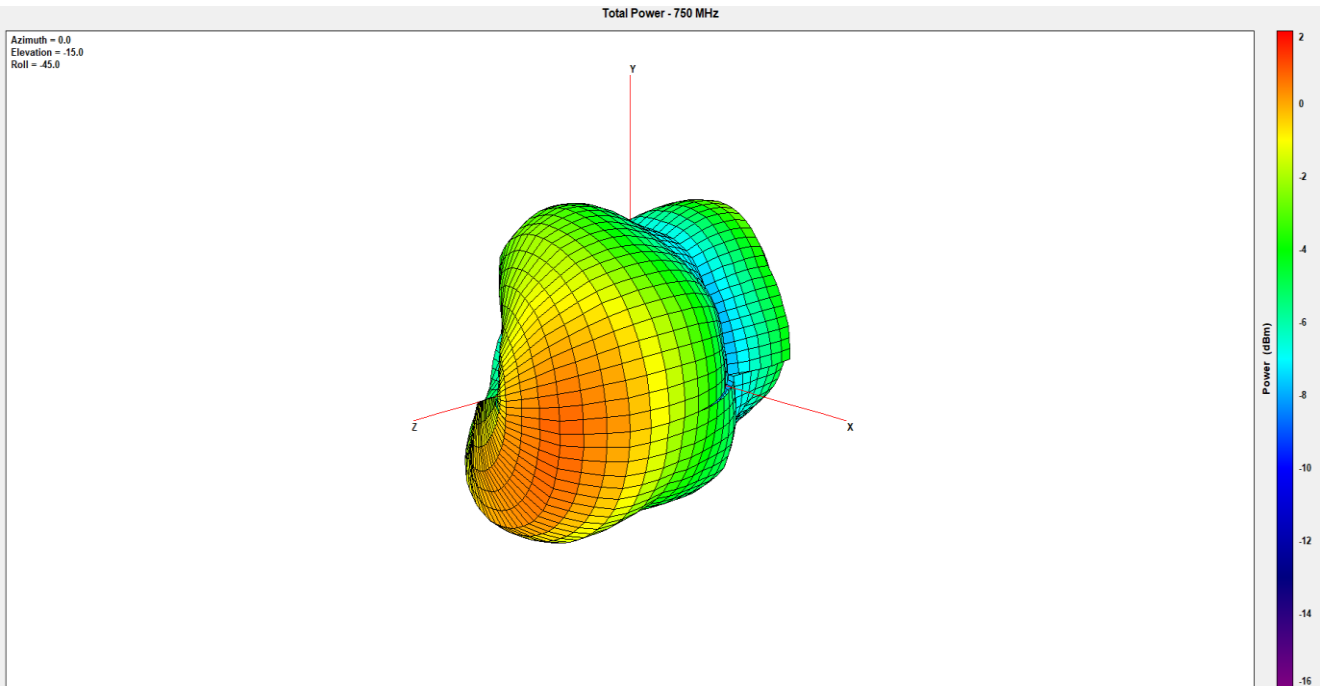

XY Plane

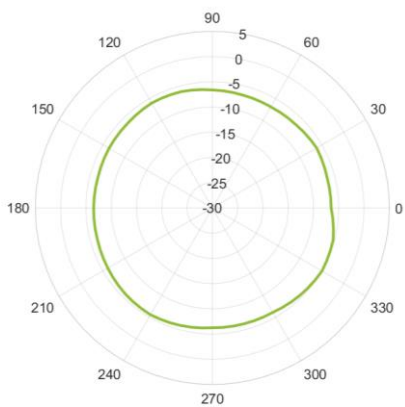

XZ Plane

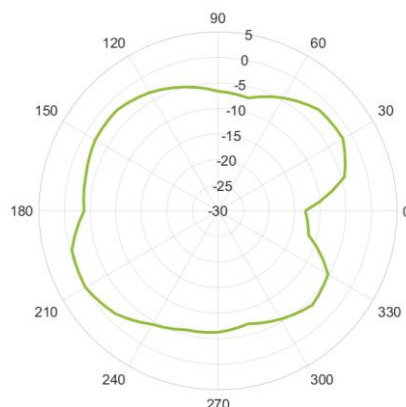

YZ Plane

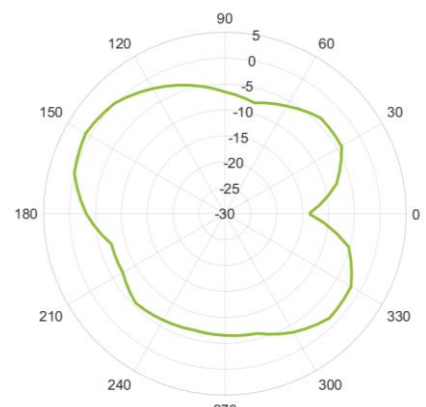

865MHz

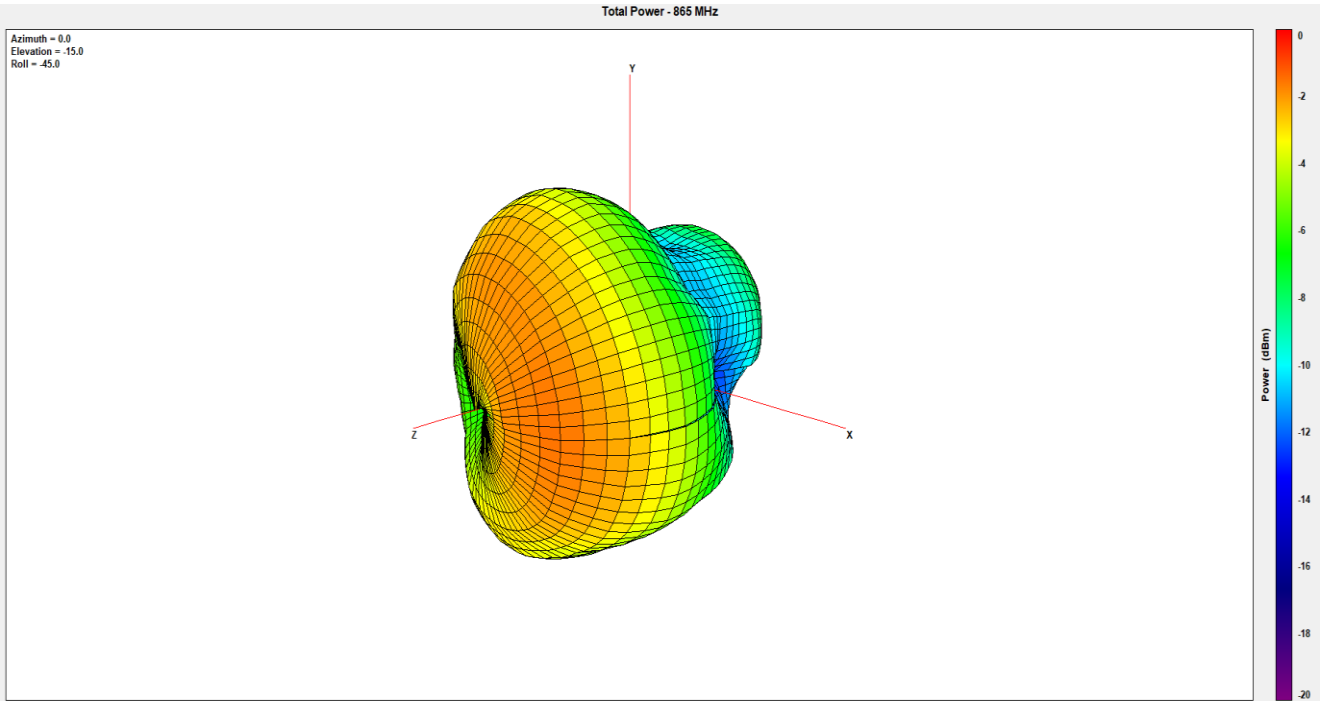

XY Plane

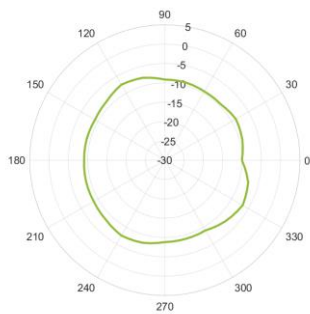

XZ Plane

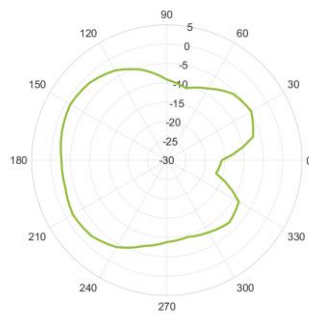

YZ Plane

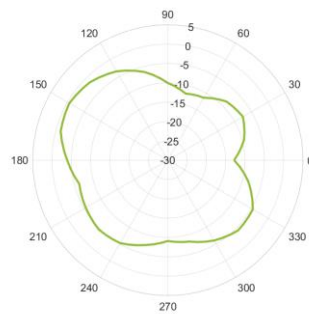

1745MHz

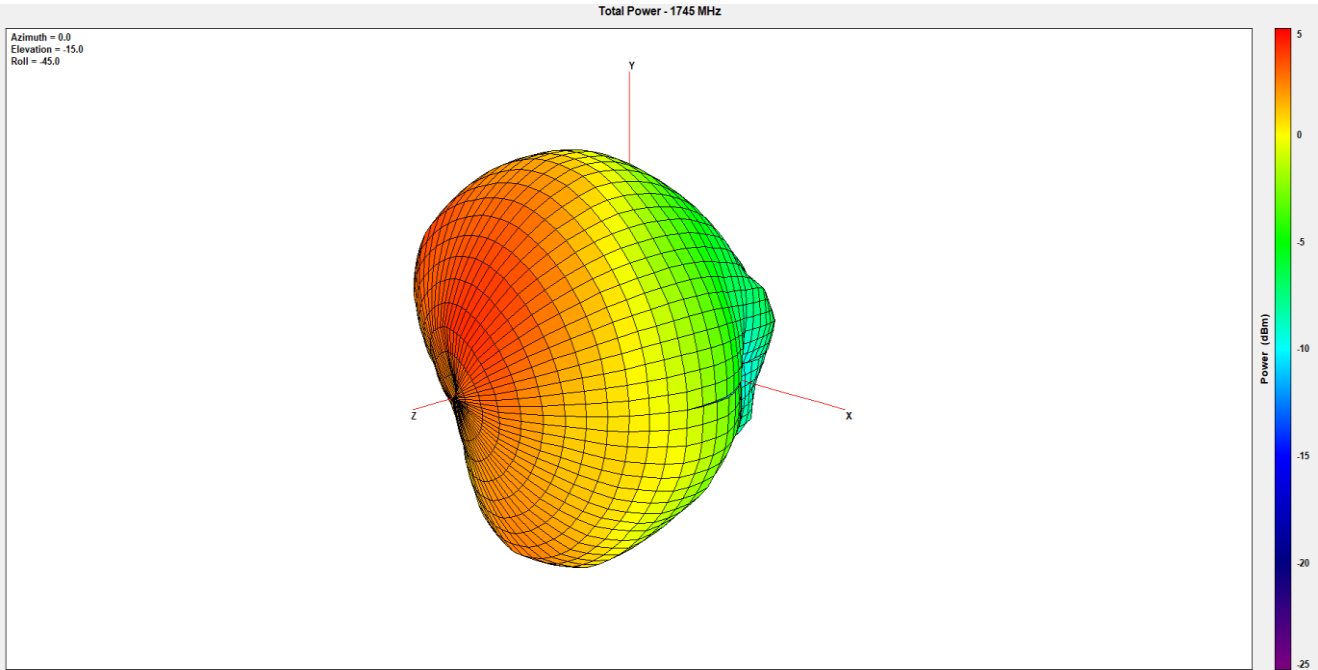

XY Plane

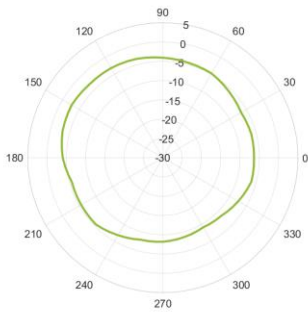

XZ Plane

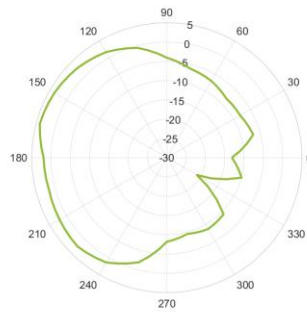

YZ Plane

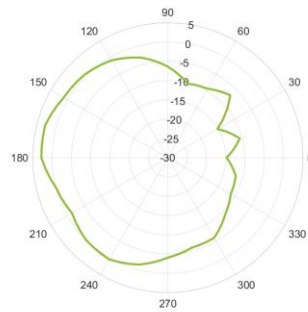

1935MHz

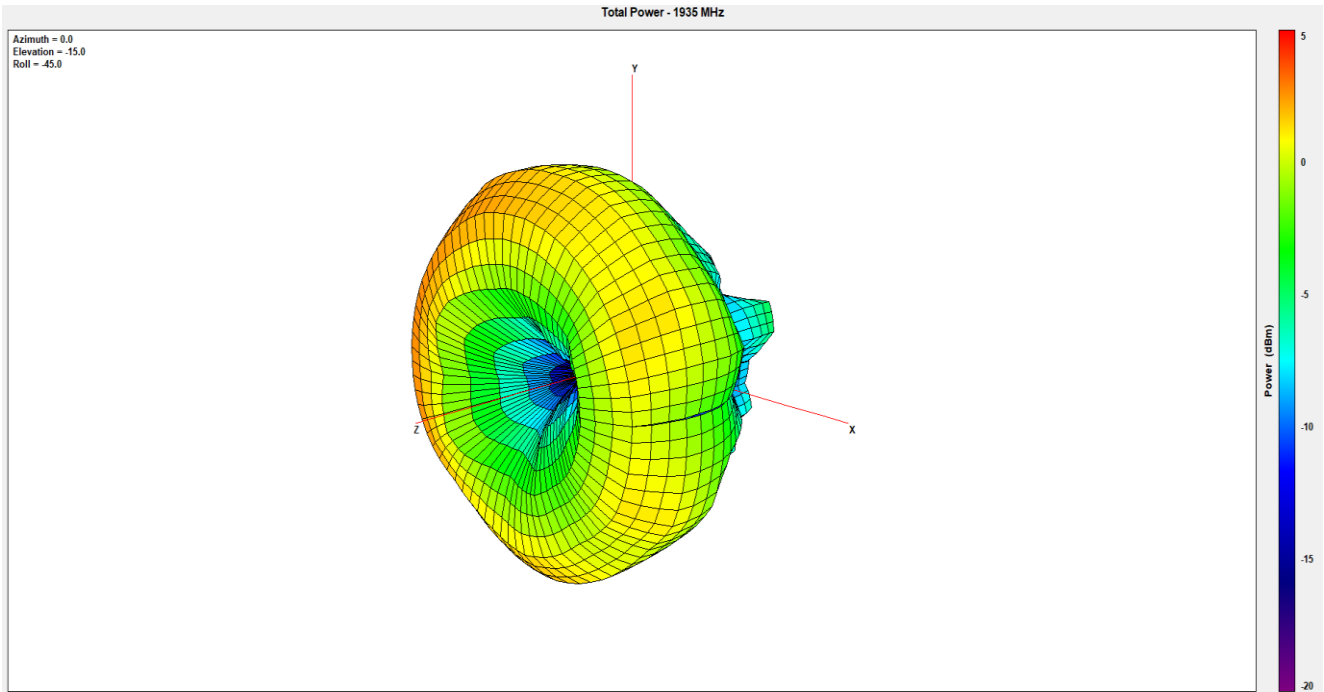

XY Plane

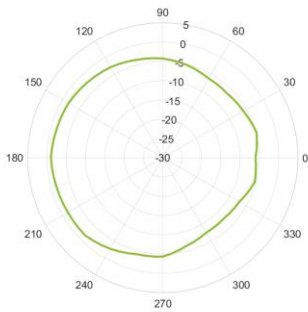

XZ Plane

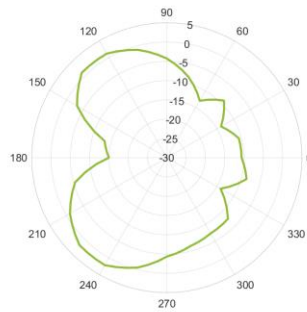

YZ Plane

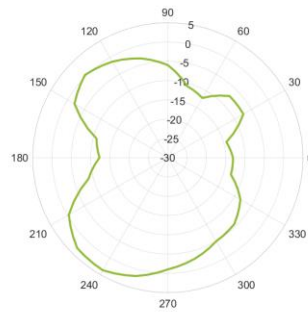

2140MHz

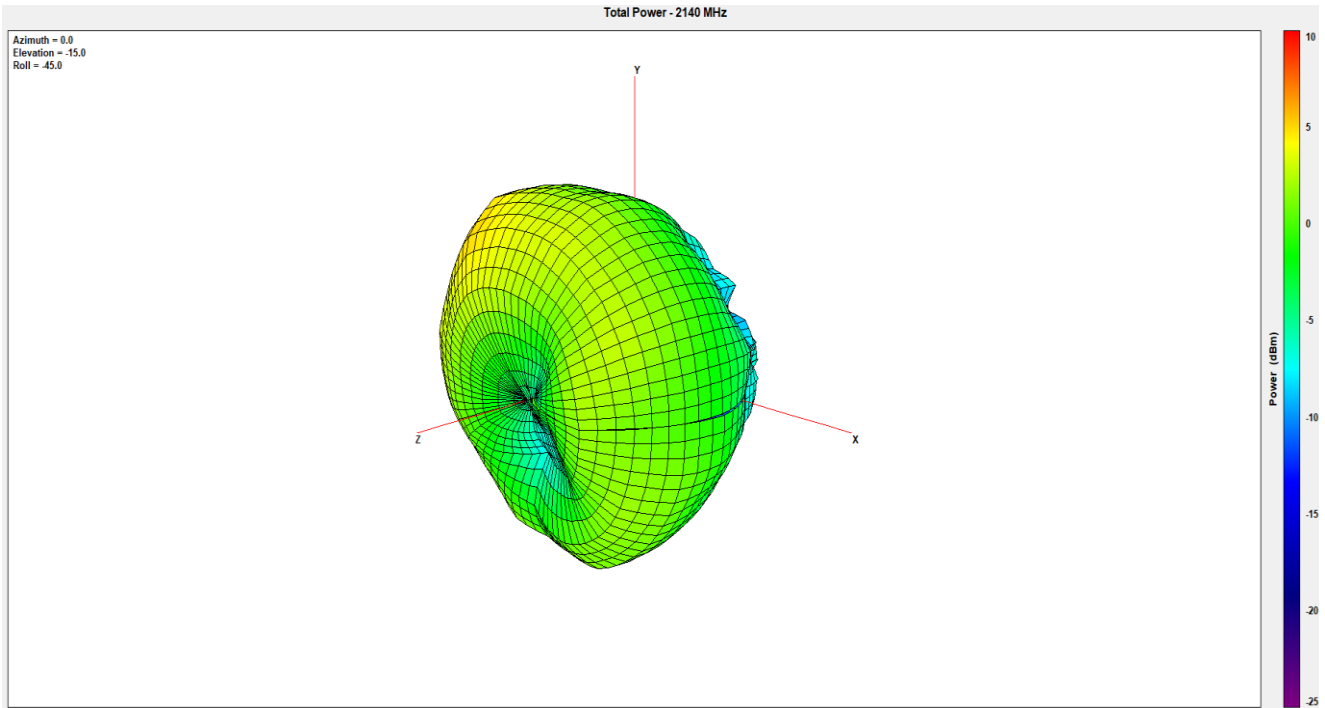

XY Plane

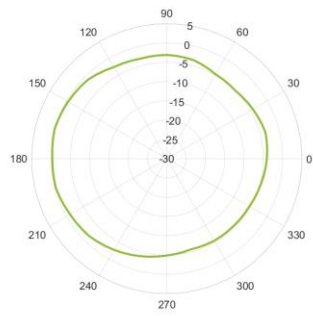

XZ Plane

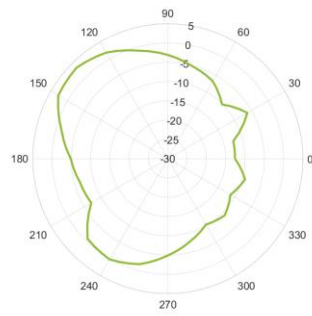

YZ Plane

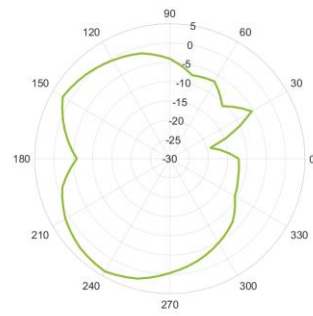

2580MHz

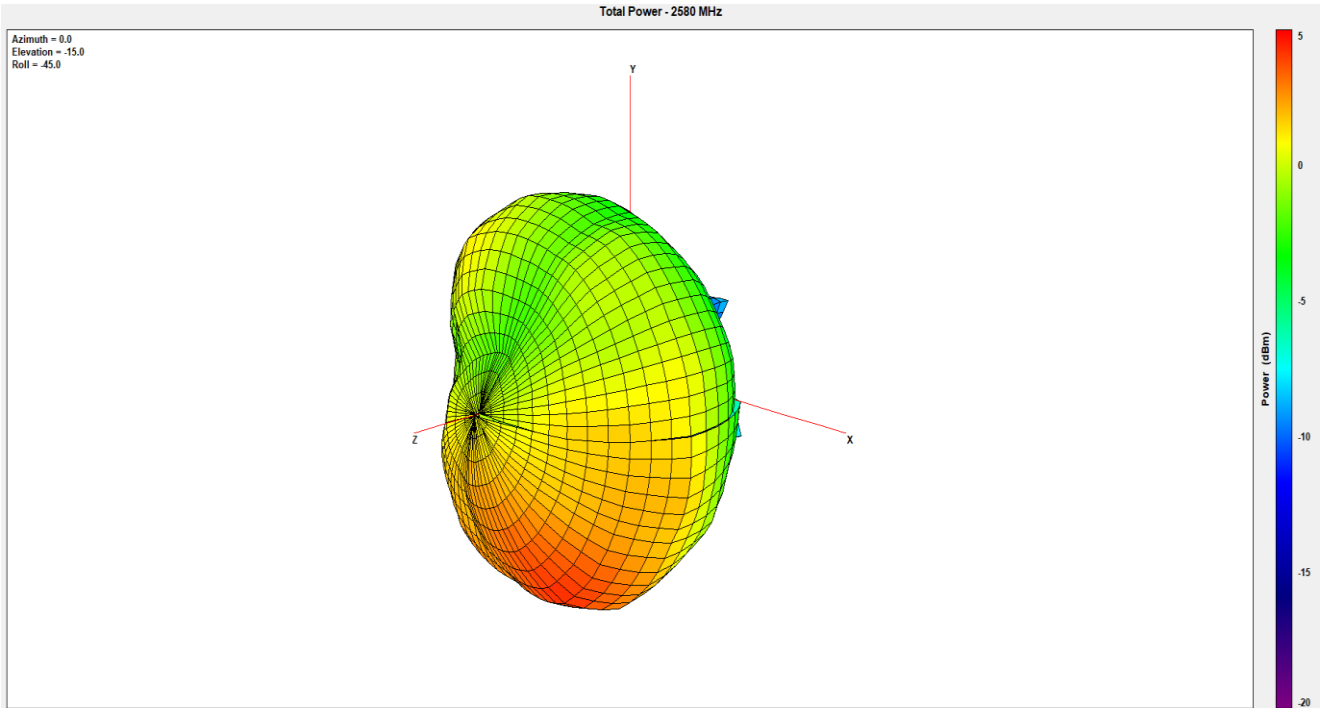

XY Plane

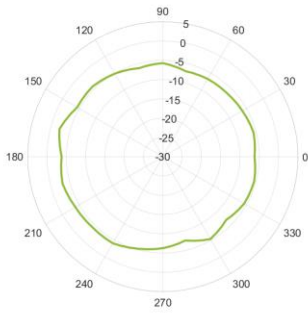

XZ Plane

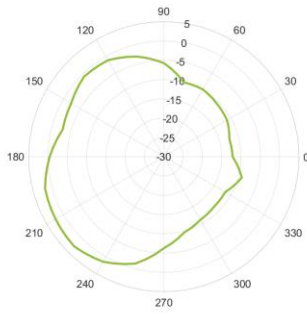

YZ Plane

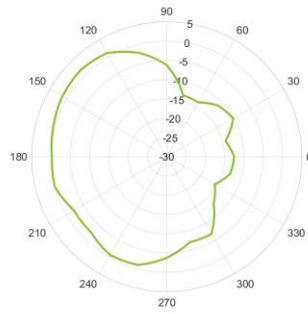

6. Mechanical Drawing (Units: mm)

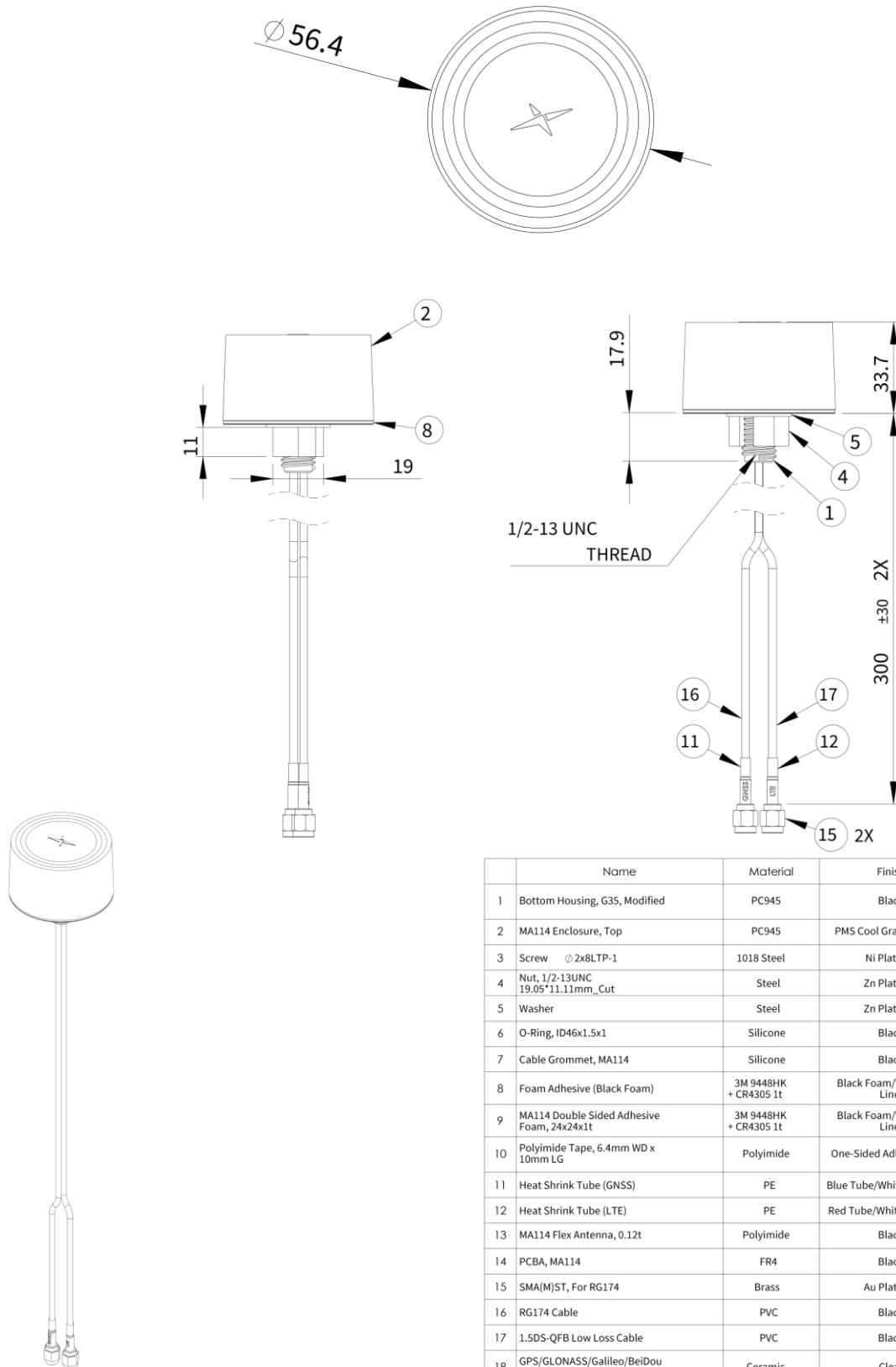

	Name	Material	Finish	QTY
1	Bottom Housing, G35, Modified	PC945	Black	1
2	MA114 Enclosure, Top	PC945	PMS Cool Gray 11	1
3	Screw ϕ 2x8LTP-1	1018 Steel	Ni Plated	3
4	Nut, 1/2-13UNC 19.05*11.11mm_Cut	Steel	Zn Plated	1
5	Washer	Steel	Zn Plated	1
6	O-Ring, ID46x1.5x1	Silicone	Black	1
7	Cable Grommet, MA114	Silicone	Black	1
8	Foam Adhesive (Black Foam)	3M 9448HK + CR4305 1t	Black Foam/White Liner	1
9	MA114 Double Sided Adhesive Foam, 24x24x1t	3M 9448HK + CR4305 1t	Black Foam/White Liner	1
10	Polyimide Tape, 6.4mm WD x 10mm LG	Polyimide	One-Sided Adhesive	1
11	Heat Shrink Tube (GNSS)	PE	Blue Tube/White Text	1
12	Heat Shrink Tube (LTE)	PE	Red Tube/White Text	1
13	MA114 Flex Antenna, 0.12t	Polyimide	Black	1
14	PCBA, MA114	FR4	Black	1
15	SMA(M)ST, For RG174	Brass	Au Plated	2
16	RG174 Cable	PVC	Black	1
17	1.5DS-QFB Low Loss Cable	PVC	Black	1
18	GPS/GLONASS/Galileo/BeiDou 25mm Active Patch	Ceramic	Clear	1

7. Installation Instructions

Installation Instructions

MA114 Series

MIMO 5G/4G Antenna



Introduction

Following these guidelines will help ensure that your Taoglas MA114 antenna is installed correctly. The MA114 is mounted via permanent through-hole mounting, as outlined below.

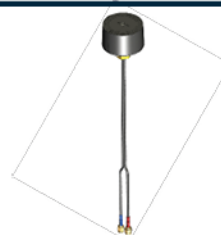

Installation Requirements

Antenna Components:

Hex Steel Nut & Washer (x1), Antenna Housing (x1), Coaxial Cable(x2), Pre-adhered Adhesive Pad(x1)

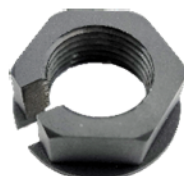
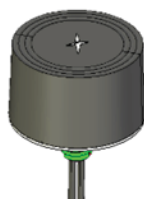

Additional Requirements:

Drill with 16mm(5/8") drill bit/hole saw

19mm [3/4in] hex wrench (optional)

Notices



Caution

To comply with FCC RF Exposure requirements in section 1.1310 of the FCC Rules, antennas used with this device must be installed to provide a separation distance of at least 20 cm from all persons to satisfy RF exposure compliance.



Warning

Do not Operate the transmitter when someone is within 20 cm of the antenna.
Do not operate the equipment in an explosive atmosphere.



European Waste Electronic Equipment Directive 2002/96/EC

Please ensure that your old Waste Electricals and Electronics are recycled do not throw them away into standard waste.

Waiver: This document represents information compiled by Taoglas to the best of our current knowledge. This is not intended to be used as a representation or warranty of fitness of the products described for any particular purpose. This document details guidelines for general information purposes only. When planning installations, always seek specialist advice and ensure that the products are always installed by a properly qualified installer in accordance with applicable regional laws and regulations.

All copyrights, trademarks and any other intellectual property rights related are owned by Taoglas Group Holdings Limited.

Permanent Mounting

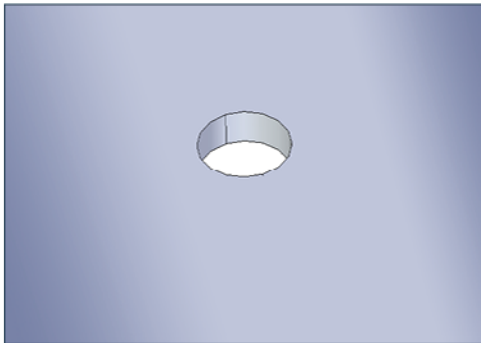

Determine where the antenna is to be mounted, please ensure this is a flat surface. Drill a 16mm [5/8"] diameter hole.

Note: Min panel thickness 4mm [5/32in], Max panel



Unscrew the split steel nut from the antenna body and slide the the coaxial cable out through nut and washer.



Ensure the mounting surface is clean and all debris, dust, or any other contaminant is removed. Remove the protective liner from the pre-installed base adhesive on the antenna.

Note: Once exposed, avoid touching the adhesive.

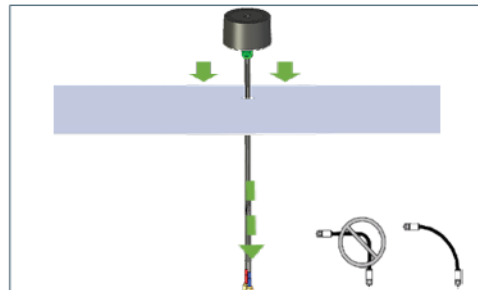

Route the coaxial cables through the hole in the panel. Align the antenna properly and press down to secure the adhesive base in place.

Note: Avoid sharp bends when routing coaxial cable.



Insert the coaxial cables through the washer and steel nut and slide them upwards. Tighten to secure the antenna in place. Ensure the nut is fully tightened.

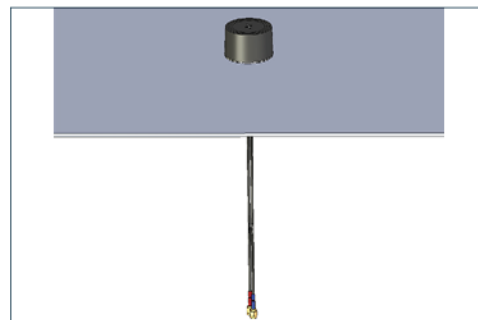

Completed Installation.

8. Packaging

1pcs per Small PE Bag
Weight - 100g

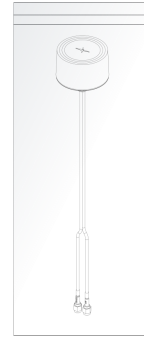

10pcs per Large PE Bag
Weight - 1Kg

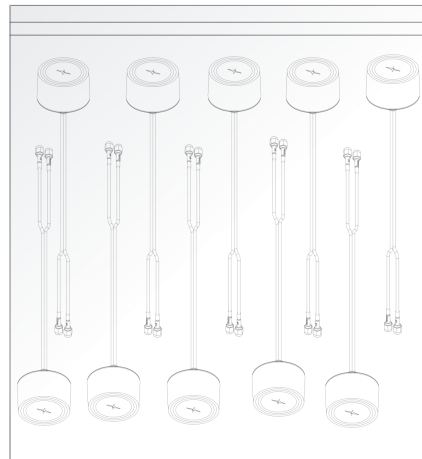

60pcs per Carton
Weight - 6Kg

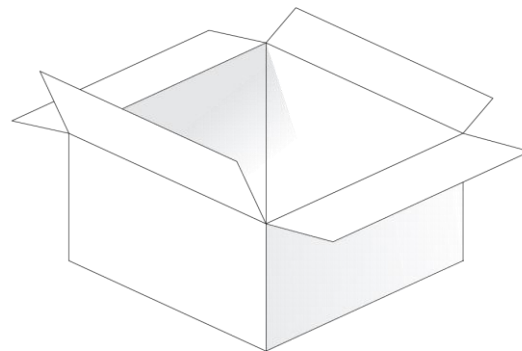

Changelog for the datasheet

SPE-21-8-012-A - MA114.A.LB.001

Revision: A (Current Version)

Date:	2021-03-08
Changes:	Initial Release
Author:	Jack Conroy

Previous Revisions



TAOGLAS®

www.taoglas.com

