

SPECIFICATION

Part No.	MA230.LBC.002
Product Name	MA230 Stream 3-in-1 Adhesive Mount Combination Antenna with GNSS, LTE & Wi-Fi.
Description	GPS / GLONASS / Galileo - 3m RG-174 & SMA(M) 4G with 3G/2G Fallback- 3m Low Loss CFD200 & SMA(M) Dual Band Wi-Fi - 3m Low Loss CFD200 & RP-SMA(M) IP67 Rated UV Resistant ABS Enclosure Dimensions: 200*66*9mm Reach & RoHS Compliant



1. Introduction

The Taoglas Stream MA230, is a 3in1 adhesive mount combination with GNSS, LTE and Wi-Fi. GPS/GLONASS/GALILEO and Dual-Band Wi-Fi are covered and as well as LTE, the MA230 offers fallback to 3G/2G bands. It is a low profile, heavy-duty, fully IP67 waterproof external M2M antenna for use by RF professionals in telematics, transportation and remote monitoring applications.

The Stream 3in1 is unique in the market as it combines the highest possible efficiency and peak gain for GNSS, 2.4/5GHz Wi-Fi and all cellular bands in a low profile compact format for mounting via high quality first tier automotive approved 3M adhesive foam. Its comes with 3m of low loss CFD200 cable for LTE and Wi-Fi, RG-174 for GNSS and SMA(M) and RP(SMA) as standard. Cables and connectors are customizable.

Many module manufacturers specify peak gain limits for any antennas that are to be connected to that module. Those peak gain limits are based on free-space conditions. In practice, the peak gain of an antenna tested in free-space can degrade by at least 1 or 2dBi when put inside a device. So ideally you should go for a slightly higher peak gain antenna than mentioned on the module specification to compensate for this effect, giving you better performance.

Upon testing of any of our antennas with your device and a selection of appropriate layout, integration technique, or cable, Taoglas can make sure any of our antennas' peak gain will be below the peak gain limits. Taoglas can then issue a specification and/or report for the selected antenna in your device that will clearly show it complying with the peak gain limits, so you can be assured you are meeting regulatory requirements for that module.

For example, a module manufacturer may state that the antenna must have less than 2dBi peak gain, but you don't need to select an embedded antenna that has a peak gain of less than 2dBi in free-space. This will give you a less optimized solution. It is better to go for a slightly higher free-space peak gain of 3dBi or more if available. Once that antenna gets integrated into your device, performance will degrade below this 2dBi peak gain due to the effects of GND plane, surrounding components, and device housing. If you want to be absolutely sure, contact Taoglas and we will test. Choosing a Taoglas antenna with a higher peak gain than what is specified by the module manufacturer and enlisting our help will ensure you are getting the best performance possible without exceeding the peak gain limits.

For further information, contact your regional Taoglas Customer Support team.

2. Antenna Specification

Performance Specifications			
Items	GPS-GLONASS-GALILEO Antenna	Cellular Antenna	Wi-Fi Antenna
Features	High performance GPS/Glonass 35*35*4mm ceramic patch antenna	LTE – 700MHz	High performance dual-band Wi-Fi 2.4/5 GHz
		LTE – 800MHz	
		CDMA: 824-896 MHz	
		GSM: 880-960 MHz	
		DCS: 1710-1880 MHz	
		PCS: 1850-1990 MHz	
		3G: 1920-2170MHz	
		LTE – 2300	
		LTE - 3500	
Gain	1575.42MHz 1.92dBi typ @ Zenith 1602MHz 3.19dBi typ @ Zenith	Average: -3.03dBi at 700– 960MHz	1.5dBi typ.@2450MHz 2.0dBi typ.@5000MHz
		-4.34dBi at 1710 – 2170MHz	
		Peak: 2.16dBi at 700 – 960MHz	
		0.42dBi at 1710 – 2170MHz	
VSWR	1.21 Max at 1575MHz 1.55Max at 1602MHz	3.3 Max. at 700- 960MHz	2.30 Max at 2400MHz 1.08Max at 5000MHz
		3.6 Max. at 1710- 1850MHz	
		2.2 Max. at 1880-2170MHz	
Impedance	50Ω	50Ω	50Ω
Efficiency		≥ 68% @ 700MHz,	≥ 40% @ 2450MHz ≥ 30% @ 5000MHz
		≥ 72% @ 750MHz,	
		≥ 66% @ 824MHz,	
		≥ 56% @ 890MHz,	
		≥ 61% @ 880MHz,	
		≥ 53% @ 960MHz,	
		≥ 37% @1710MHz,	
		≥ 51% @1880MHz,	
		≥ 55% @1990MHz,	
		≥ 54% @2110MHz,	
		≥ 45% @2170MHz,	
		@2300MHz,	
		@3500MHz	

MECHANICAL

Items	GPS-GLONASS-GALILEE Antenna	Cellular Antenna	Wi-Fi Antenna
Cable / Connector	3M RG-174 with SMA(M) Fully Customisable	3M CFD-200 with SMA(M) Fully customisable	3M CFD-200 with RP-SMA(M) Fully customisable
Housing	UV resistant ABS		
Adhesive Mount	3M 1600TB(196.57*62.57*1.25mm)		
Protection Class	IP-67		

ENVIRONMENTAL

Operation Temperature	-40°C to +85°C
Storage Temperature	-40°C to +85°C
Relative Humidity	20% to 95%
Weight per unit	0.18kg

LTE BANDS			
Band Number	LTE / LTE-Advanced / WCDMA / HSPA / HSPA+ / TD-SCDMA		
	Uplink	Downlink	Covered
1	UL: 1920 to 1980	DL: 2110 to 2170	✓
2	UL: 1850 to 1910	DL: 1930 to 1990	✓
3	UL: 1710 to 1785	DL: 1805 to 1880	✓
4	UL: 1710 to 1755	DL: 2110 to 2155	✓
5	UL: 824 to 849	DL: 869 to 894	✓
7	UL: 2500 to 2570	DL: 2620 to 2690	✗
8	UL: 880 to 915	DL: 925 to 960	✓
9	UL: 1749.9 to 1784.9	DL: 1844.9 to 1879.9	✓
11	UL: 1427.9 to 1447.9	DL: 1475.9 to 1495.9	✗
12	UL: 699 to 716	DL: 729 to 746	✓
13	UL: 777 to 787	DL: 746 to 756	✓
14	UL: 788 to 798	DL: 758 to 768	✓
17	UL: 704 to 716	DL: 734 to 746 (LTE only)	✓
18	UL: 815 to 830	DL: 860 to 875 (LTE only)	✓
19	UL: 830 to 845	DL: 875 to 890	✓
20	UL: 832 to 862	DL: 791 to 821	✓
21	UL: 1447.9 to 1462.9	DL: 1495.9 to 1510.9	✗
22	UL: 3410 to 3490	DL: 3510 to 3590	✗
23	UL: 2000 to 2020	DL: 2180 to 2200 (LTE only)	✓
24	UL: 1625.5 to 1660.5	DL: 1525 to 1559 (LTE only)	✗
25	UL: 1850 to 1915	DL: 1930 to 1995	✓
26	UL: 814 to 849	DL: 859 to 894	✓
27	UL: 807 to 824	DL: 852 to 869 (LTE only)	✓
28	UL: 703 to 748	DL: 758 to 803 (LTE only)	✓
29	UL: -	DL: 717 to 728 (LTE only)	✓
30	UL: 2305 to 2315	DL: 2350 to 2360 (LTE only)	✗
31	UL: 452.5 to 457.5	DL: 462.5 to 467.5 (LTE only)	✗
32	UL: -	DL: 1452 - 1496	✗
35		1850 to 1910	✓
38		2570 to 2620	✗
39		1880 to 1920	✓
40		2300 to 2400	✗
41		2496 to 2690	✗
42		3400 to 3600	✗
43		3600 to 3800	✗

*Covered bands represent an efficiency greater than 20%

3. GPS-GLONASS-GALILEO Antenna

3.1. Return Loss

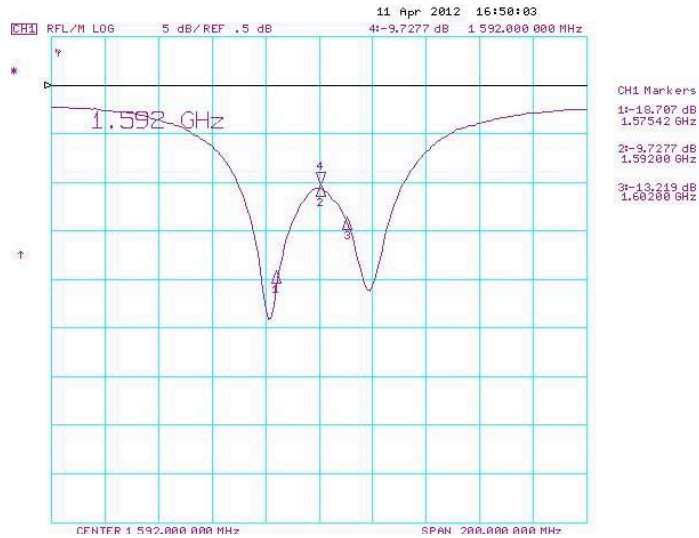

Return Loss : -18.70 dB @ 1575MHz, -13.21 dB @ 1602MHz

3.2. Smith Chart

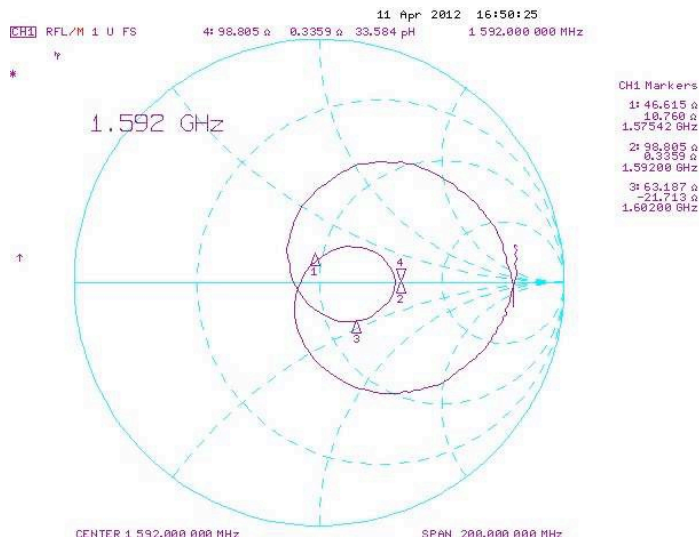

Impedance : 46.61 +j10.76 Ohm@ 1575MHz, 63.18 -j21.73 Ohm@ 1602MHz

3.3. VSWR

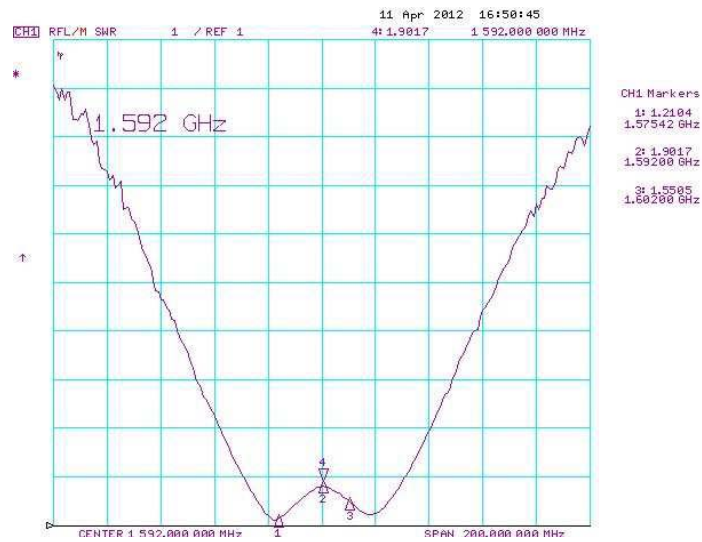

VSWR : 1.21 @ 1575MHz, 1.55 @ 1602MHz

3.4. Radiation patterns

XZ Plane

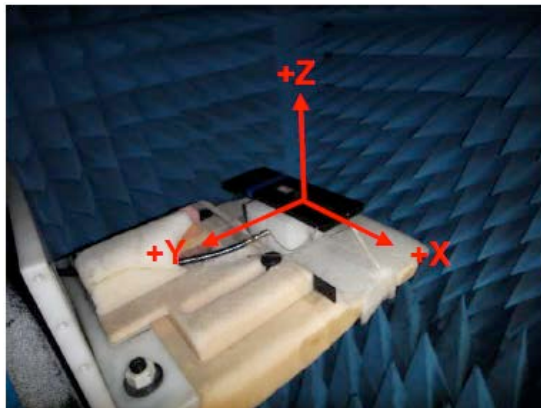

YZ Plane

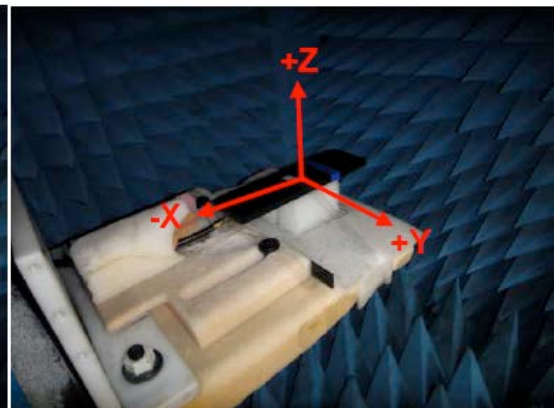

XZ Plane 1575.42MHz Horizontal & Vertical

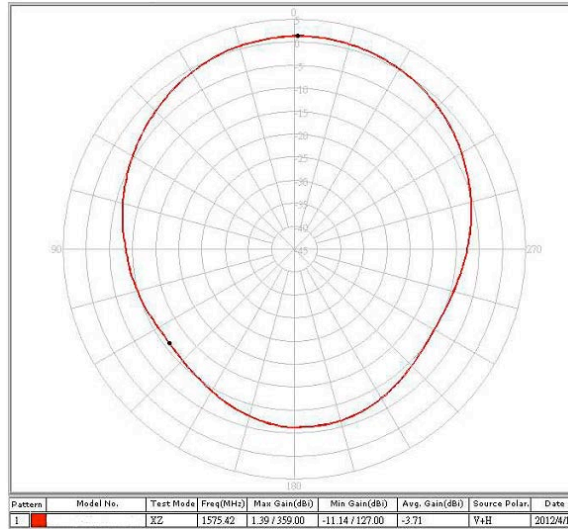

1575 MHz	Peak Gain	Zenith Gain
V+H	1.39	1.35

(dBi)

XZ Plane 1602MHz Horizontal & Vertical

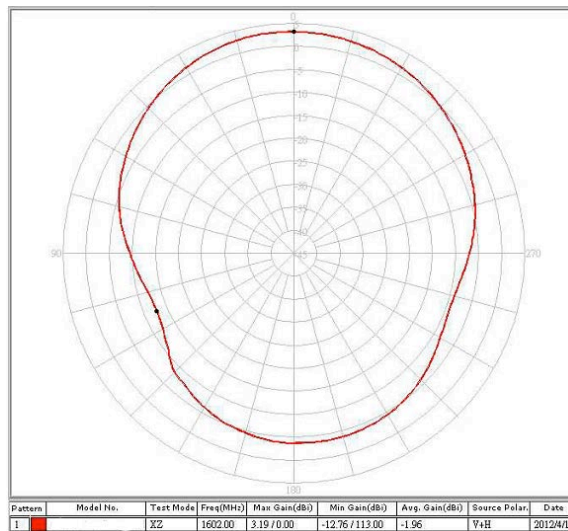

1602 MHz	Peak Gain	Zenith Gain
V+H	3.19	3.19

(dBi)

YZ Plane 1575.42MHz Horizontal & Vertical

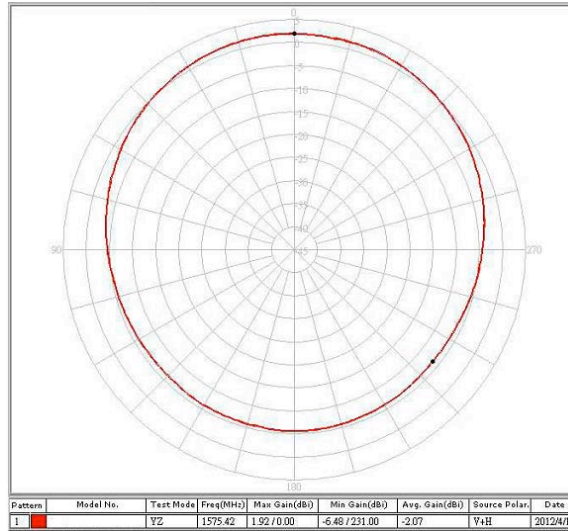

1575 MHz	Peak Gain	Zenith Gain
V+H	1.92	1.92

(dBi)

YZ Plane 1602MHz Horizontal & Vertical

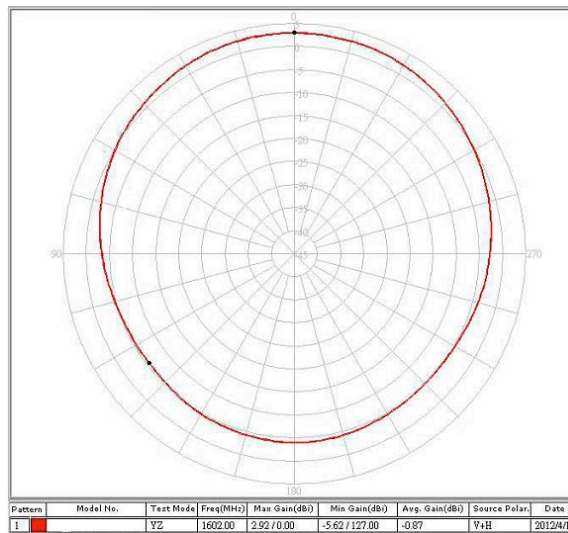

1602 MHz	Peak Gain	Zenith Gain
V+H	2.92	2.92

(dBi)

3.5. LNA characteristics

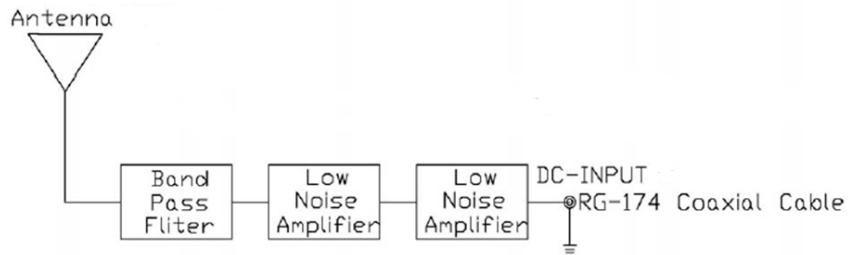

Output Impedance	50 Ohm
Output Power at 1dB Compression Point	-35dBm typ.
Output VSWR	2.0 Max.

Supply Voltage	Gain(Typ)	Noise Figure(Typ)	Power Consumption (Typ.)
1.8V	27.0dB	2.2dB	5.5mA
3.0V	32.9dB	2.3dB	12.5mA
5.5V	33.8dB	2.5dB	15.0mA

3.6. LNA Noise Figure at 3.0V

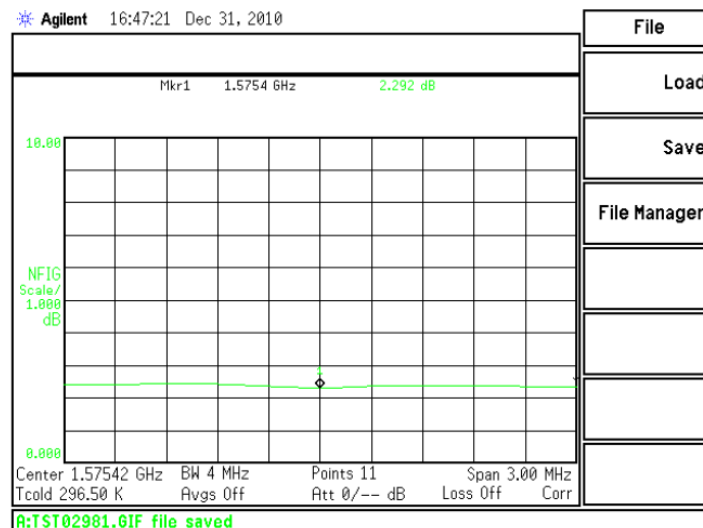

LNA Gain and Output of VSWR at 3.0V

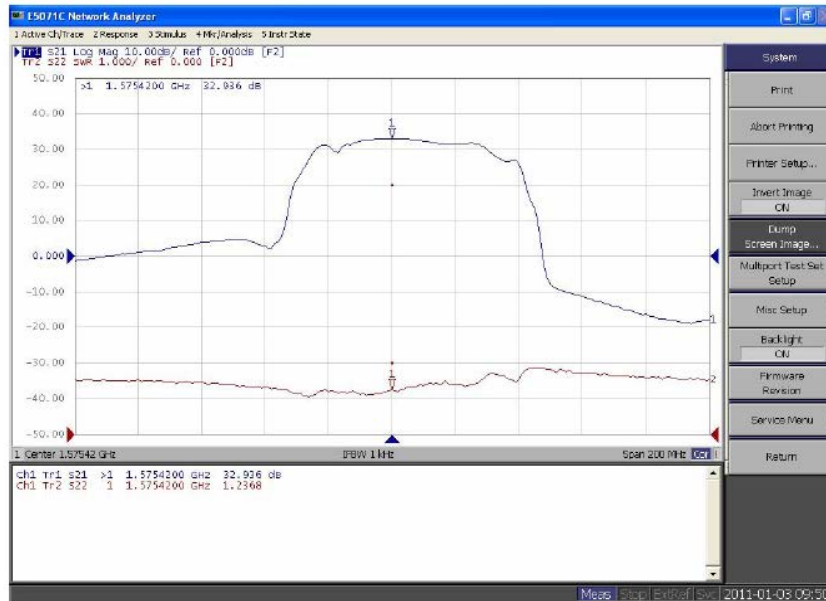

20dBmin isolation to LNA input and LTE/ GSM/ CDMA/UMTS /HSPA antenna

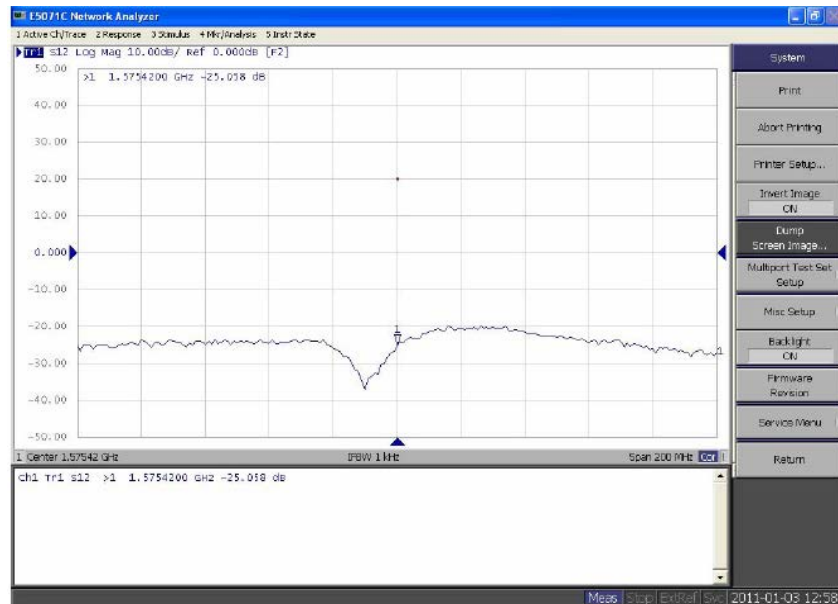

4. Cellular 4G/3G/2G Antenna

4.1. Return Loss

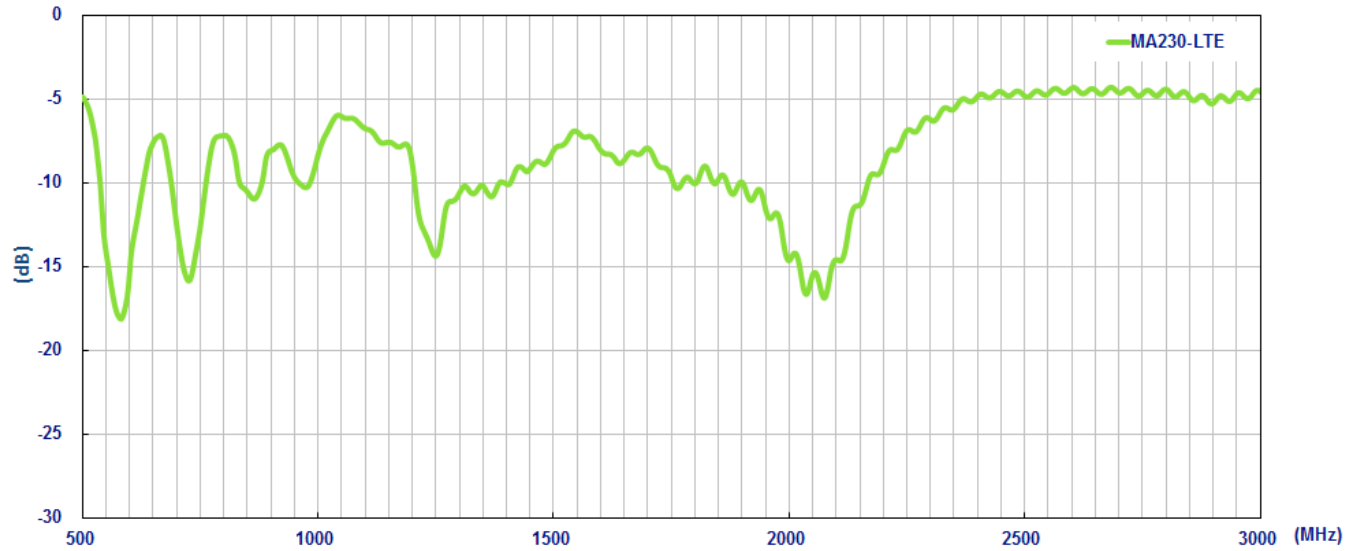

4.2. Efficiency

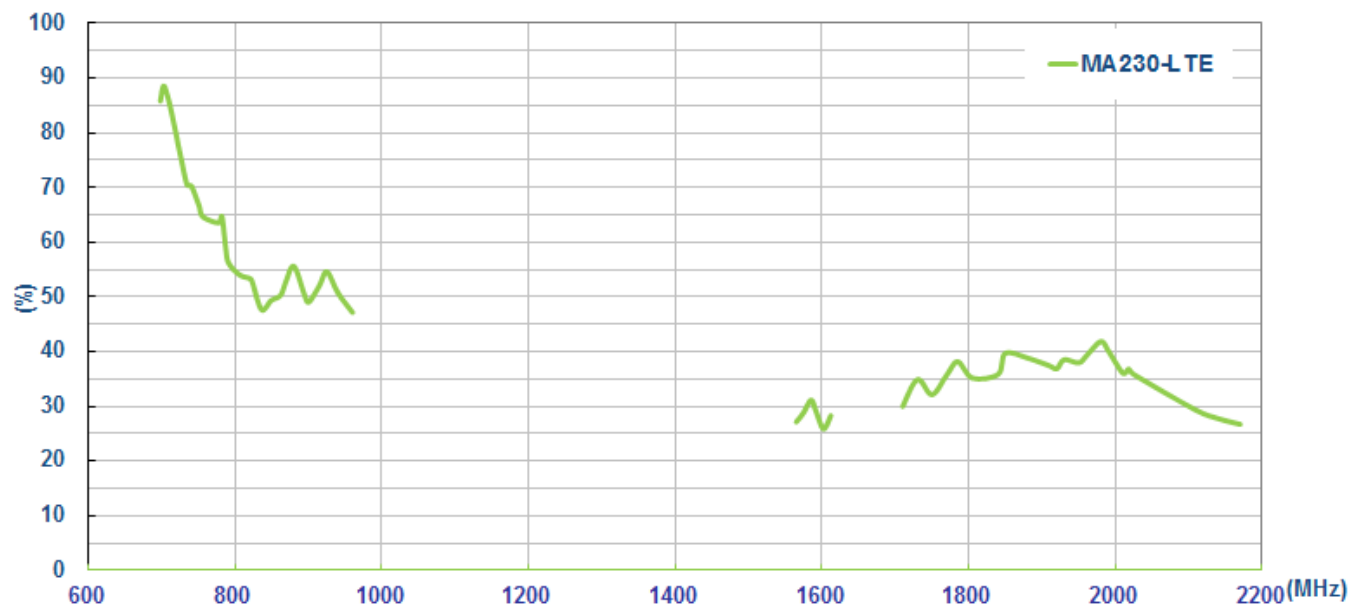

4.3. Peak Gain

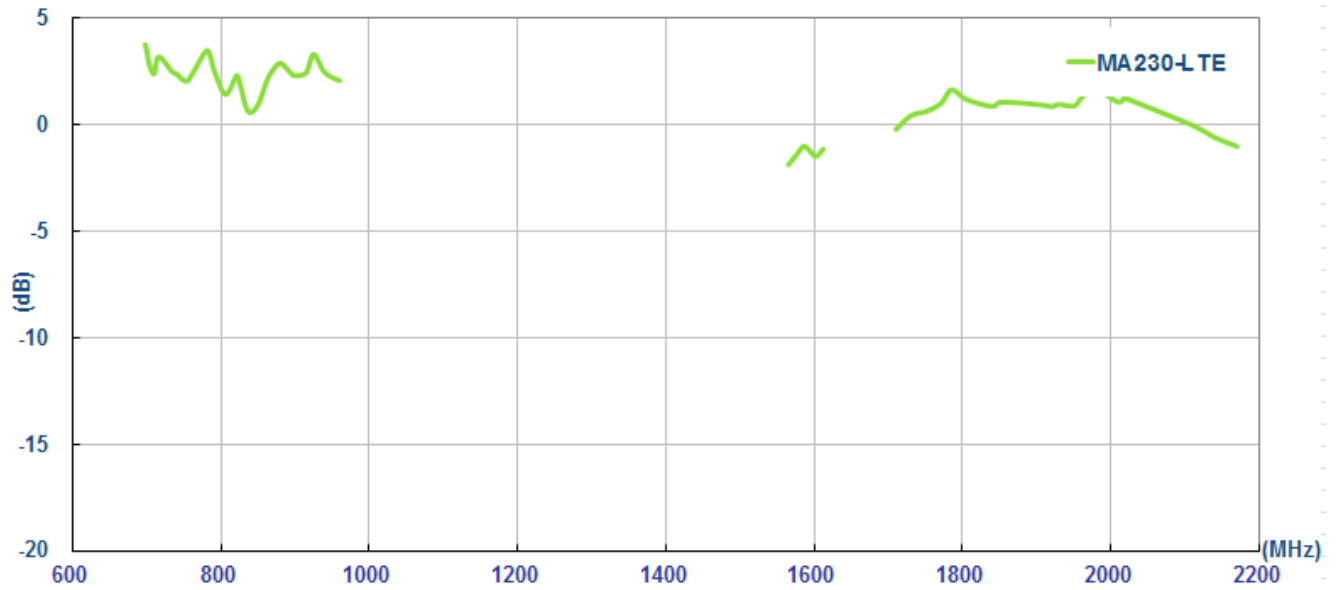

4.4. Average Gain

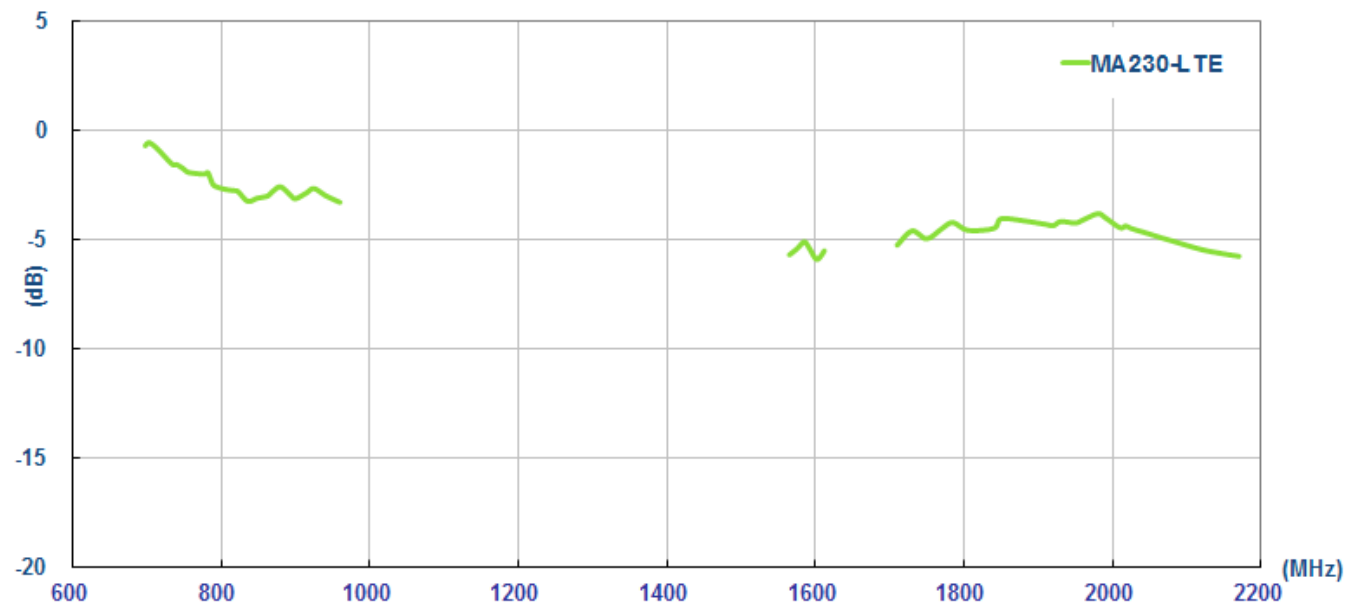

4.5. Radiation patterns

Measurement setup

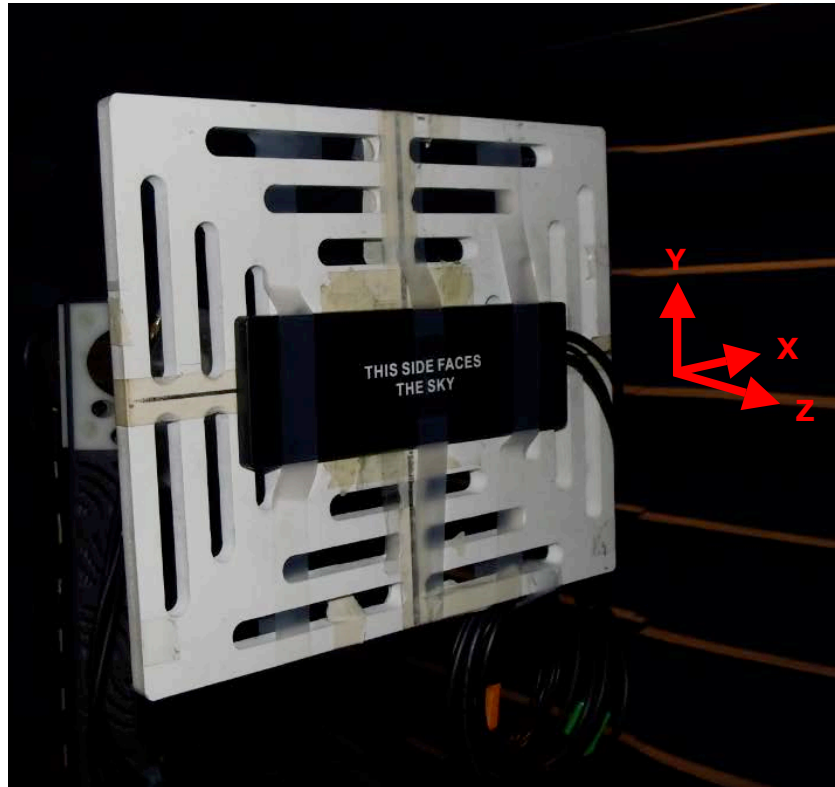

XY Plane

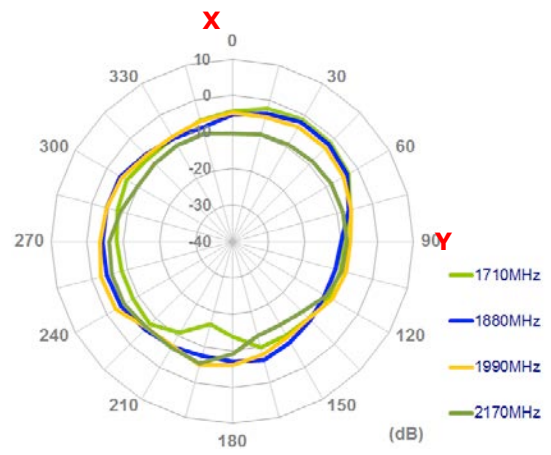
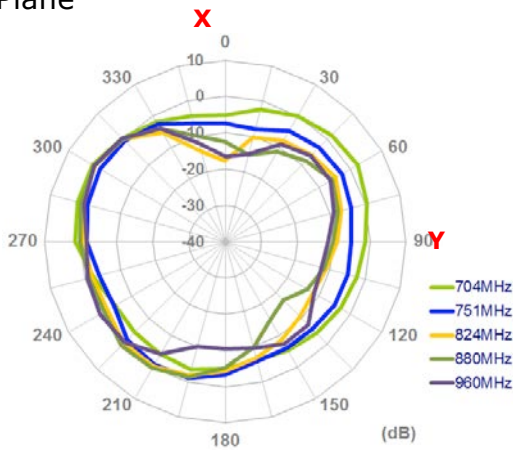

XZ Plane

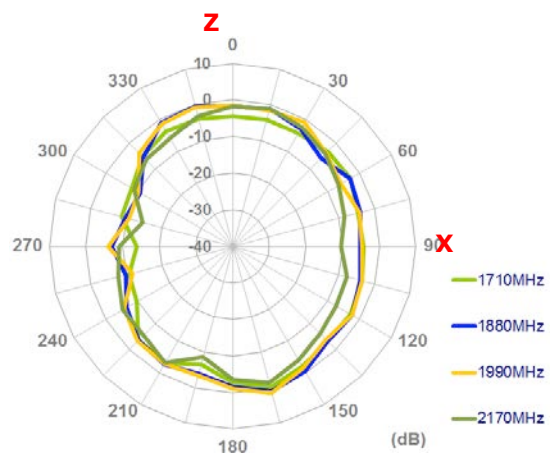
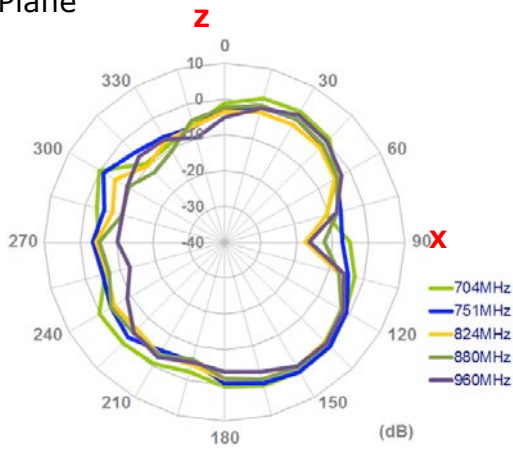

YZ Plane

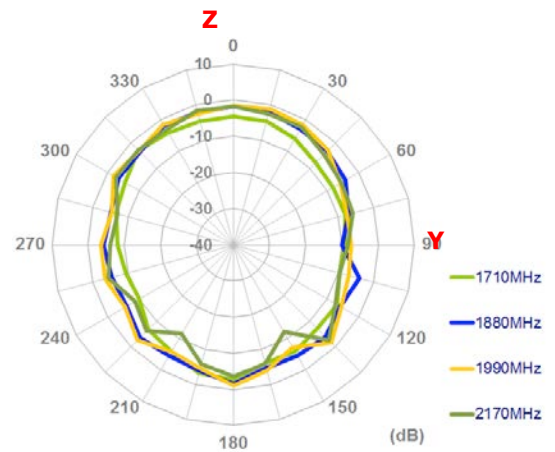
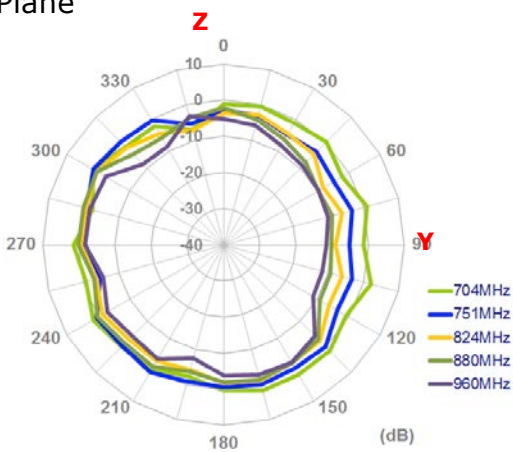

5. Wi-Fi 2.4/5.0 GHz antenna

5.1. Return Loss

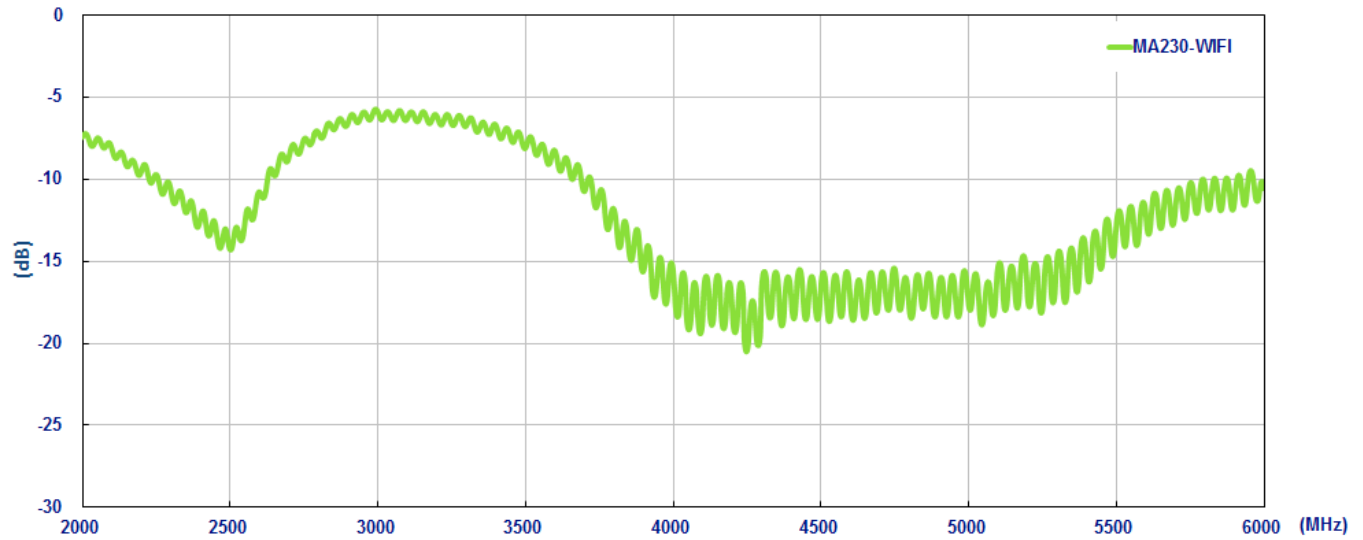

5.2. Efficiency

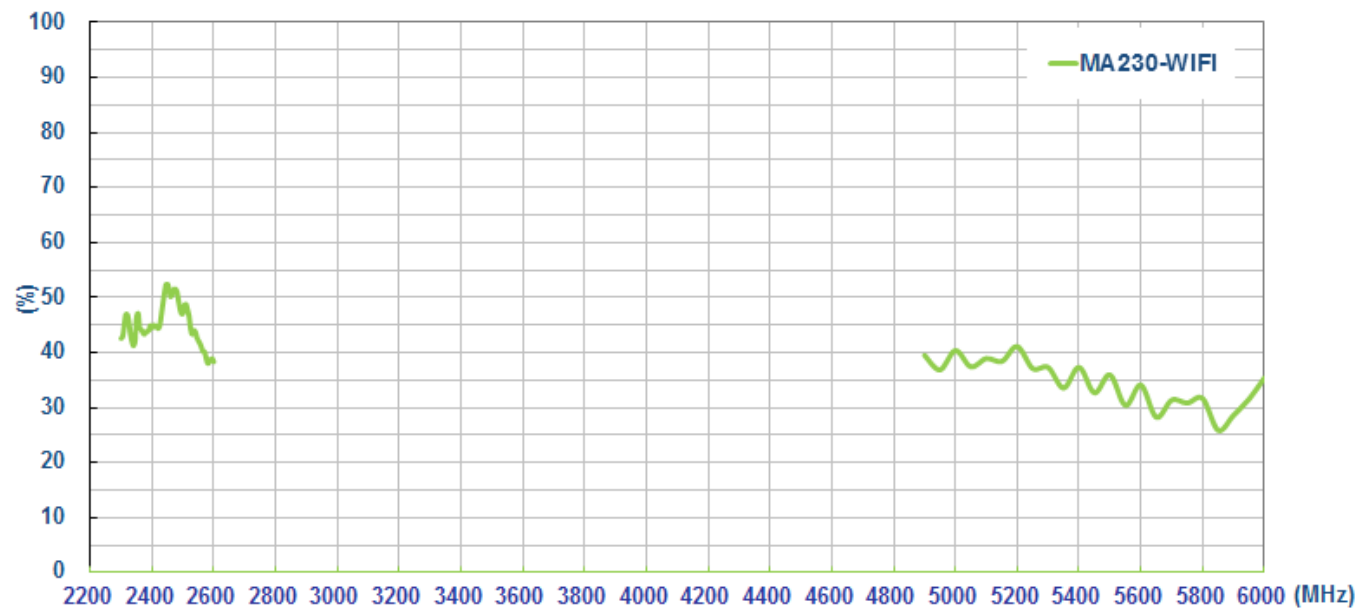

5.3. Peak Gain

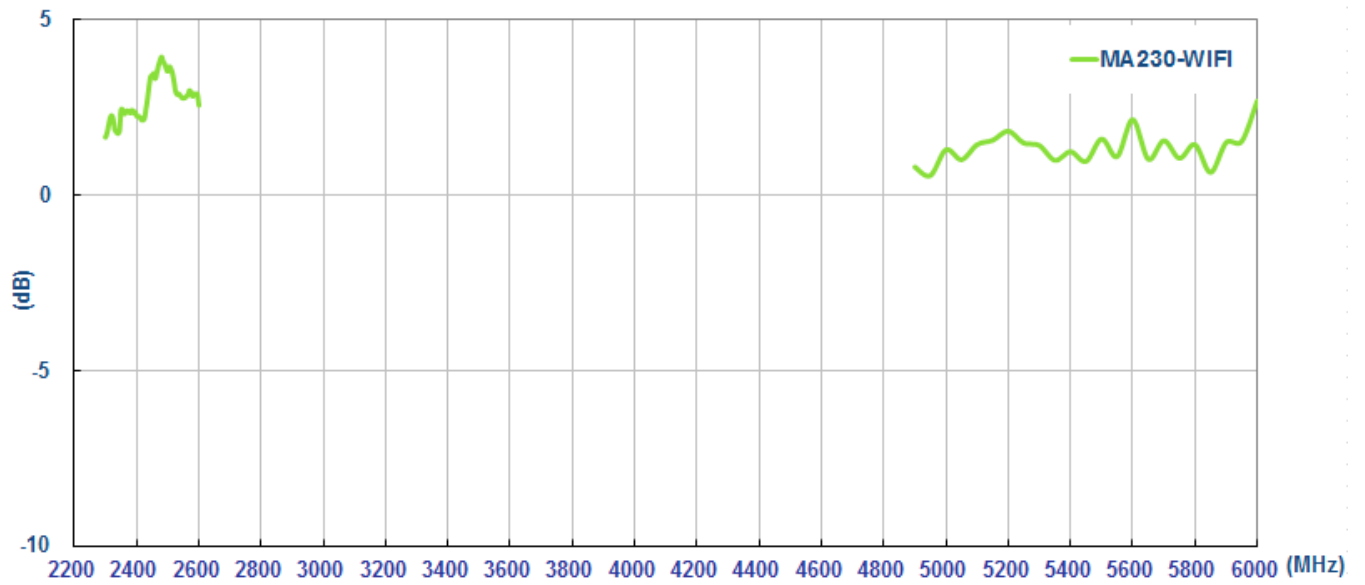

5.4. Average Gain

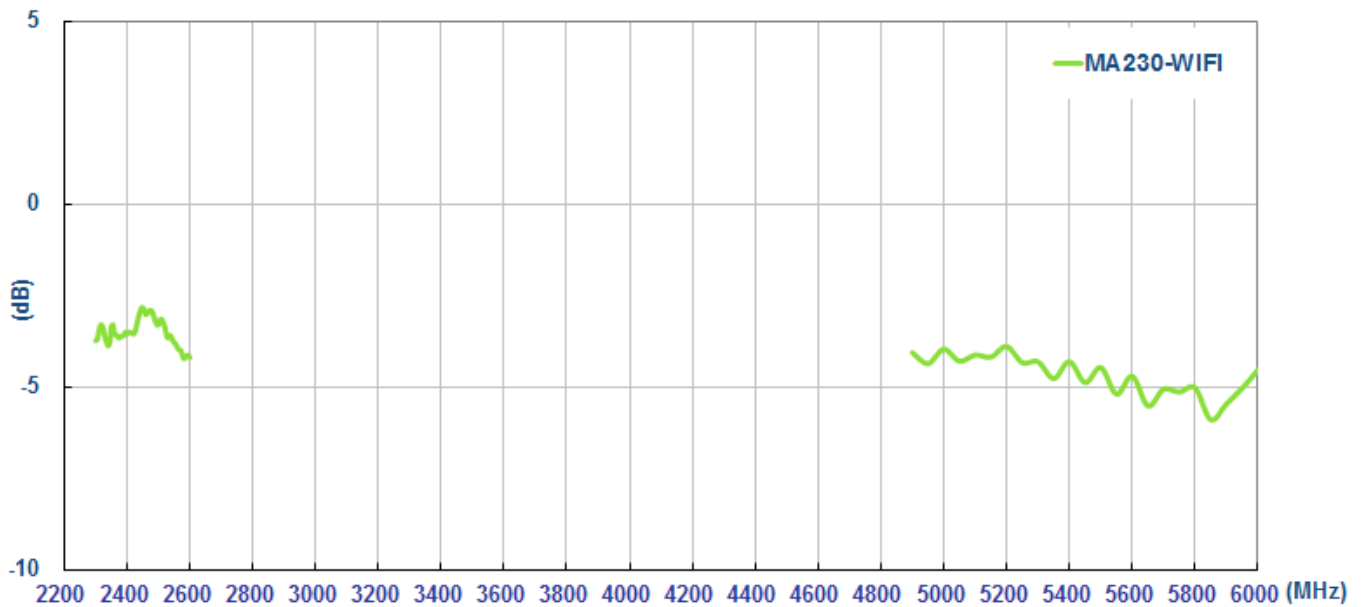

5.5. Radiation patterns

Measurement setup

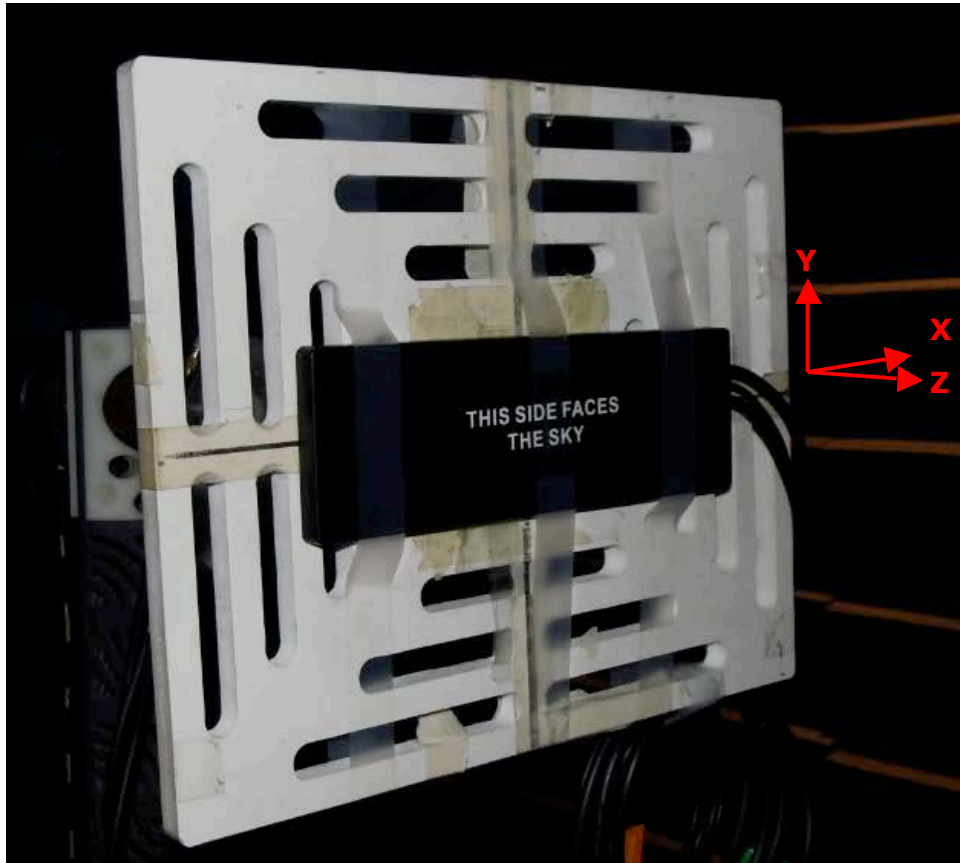

XY Plane

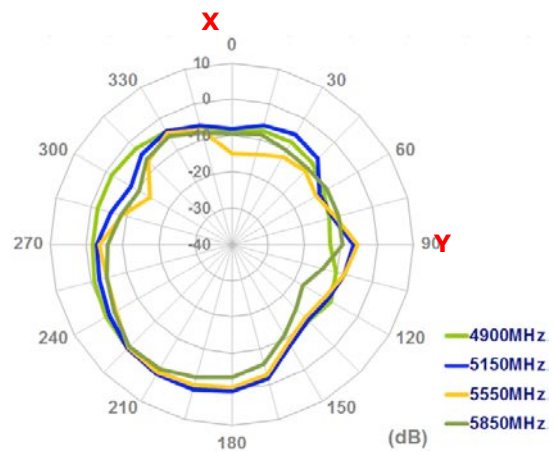
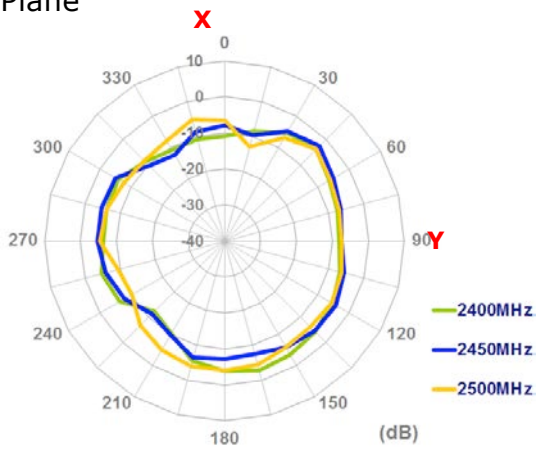

XZ Plane

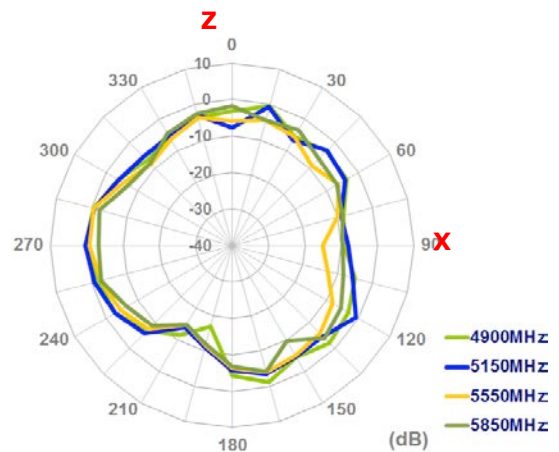
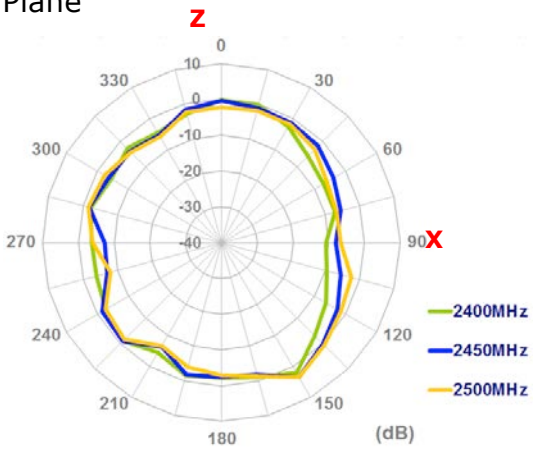

YZ Plane

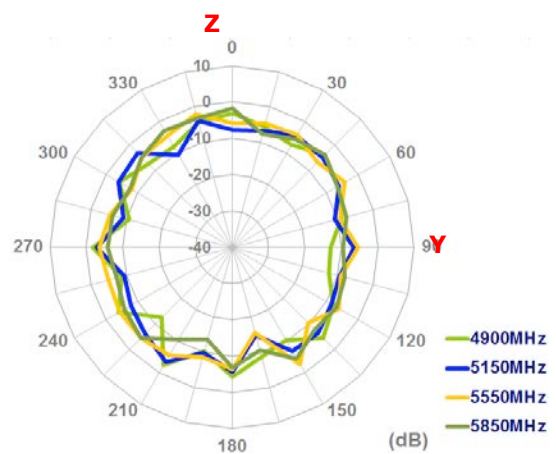
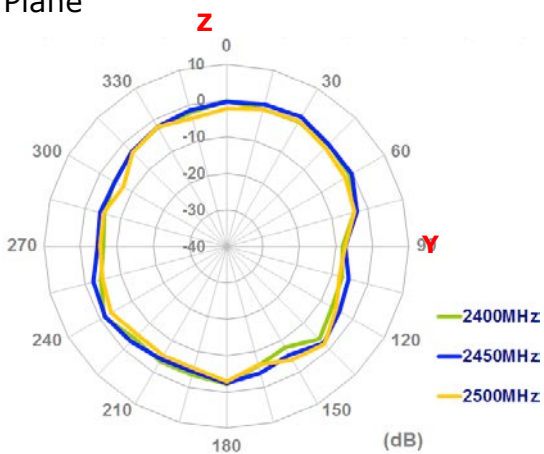

8. Drawing

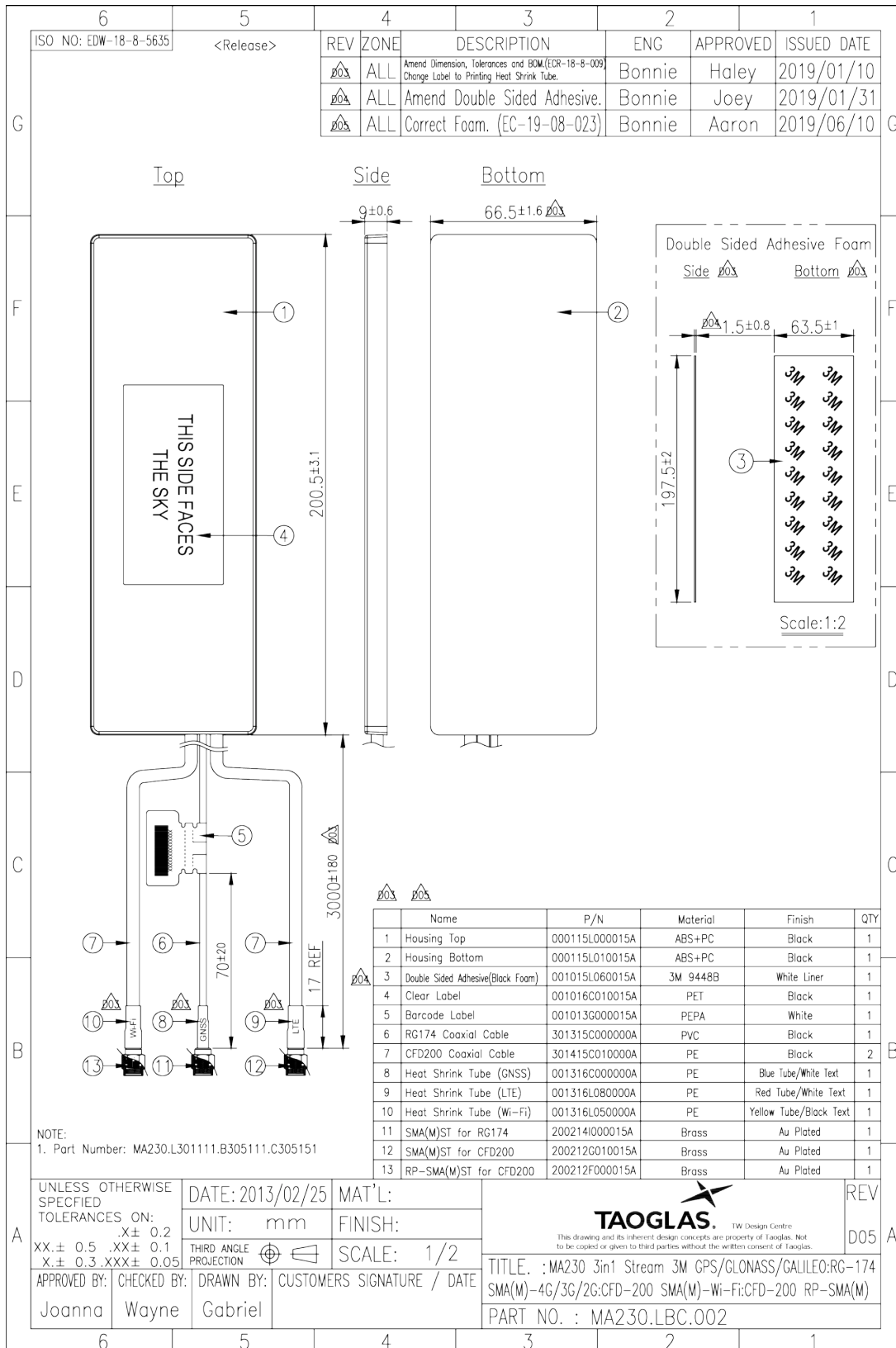

9. Packaging

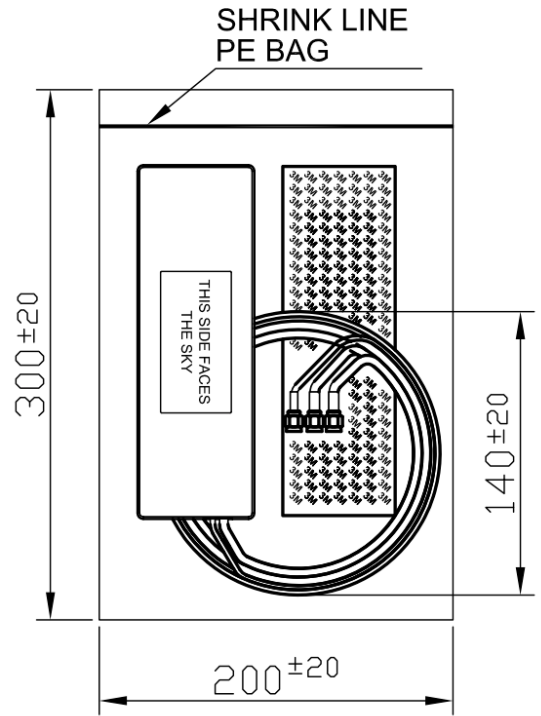

PACKING: 1PCS/BAG

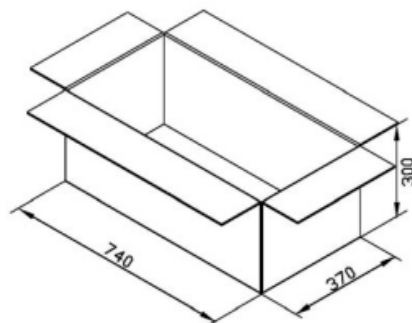
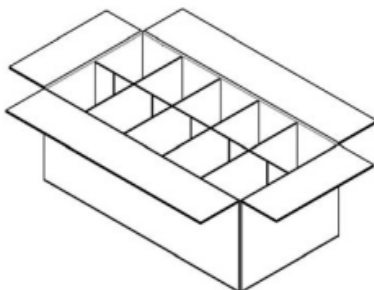
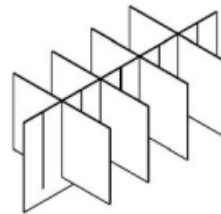
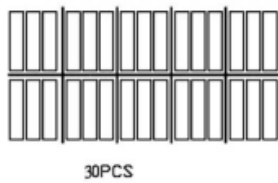

Taoglas makes no warranties based on the accuracy or completeness of the contents of this document and reserves the right to make changes to specifications and product descriptions at any time without notice. Taoglas reserves all rights to this document and the information contained herein.

Reproduction, use or disclosure to third parties without express permission is strictly prohibited.

Copyright © Taoglas