

## SPECIFICATION

- Part No. : **MA605.A.ABC.001**
- Product Name : Spartan Antenna 3in1 MA.605  
Low Profile Screw-Mount (Permanent Mount)  
GPS/GLONASS/GALILEO, Cellular, Dual band  
Wi-Fi 2.4~5.8GHz antenna
- Features : Cellular 850/900/1700/1800/2100MHz  
GSM/CDMA/UMTS/HSPA  
GPS/GLONASS/GALILEO – 4 dBic  
2.4GHz~5.8GHz 4dBi (incl. 3m cable)  
IP67 Waterproof  
High Efficiency / Peak Gain Outdoor Antenna  
Advanced RF Design and Materials  
Heavy Duty – Integrated Metal Base/  
Ground-plane  
ABS High Isolation Gasket  
Custom cables and connectors available  
**RoHS Compliant**



## 1. Introduction

The Spartan MA605 antenna is a low profile, heavy-duty, fully IP67 waterproof external M2M antenna for use in telematics, transportation and remote monitoring applications.

The Spartan MA605 antenna is unique in the market because it combines 3in1 GPS/GLONASS/GALILEO, Cellular (3G and 2G) and Wi-Fi antennas in a heavy-duty structure with high efficiency in a low profile compact format. The antenna screws down permanently onto a roof or metal panel and can be pole or wall-mounted.

Antenna includes a high isolation gasket to reduce risk of high voltage current on the mounting area, which prevents metal area short circuiting through the cable.

For industries such as commercial vehicle telematics, remote monitoring, smart meter systems, construction equipment, at only 40mm high, the Spartan provides an unobtrusive, robust, rugged antenna that is durable even in extreme environments.

Custom designed integrated wall mounted and pole mounted brackets are available for the Spartan antennas. These patent pending mounts allow for 180 degrees freedom of movement of the antennas for ease of positioning while also preventing access to the cables so they cannot be cut by vandals or thieves and also protecting the cables from long term weather exposure. The removal of unsightly cables also leads to a cleaner more professional installation and look, and makes the antenna less identifiable and more unobtrusive. Customized cable sleeves can be supplied for extra protection where required.

## 2. Specification

GPS-GLONASS-GALILEO						
Centre Frequency	1575.42MHz / 1602MHz					
Bandwidth	10MHz					
Radiation Efficiency	50(without cable)					
Passive Gain @ Zenith	4.0 typ(with $\psi=140$ mm ground)					
VSWR	2					
Impedance	50 $\Omega$					
DC Power Input Range	3 ~ 5V					
DC input	<b>3.3V</b>		<b>4.0V</b>		<b>5.5V</b>	
<b>MHz</b>	<b>1575.42</b>	<b>1602</b>	<b>1575.42</b>	<b>1602</b>	<b>1575.42</b>	<b>1602</b>
VSWR	2	2	2	2	2	2
LNA Gain	29.2	29	31	31	32.3	32
Noise Figure	3.1	3.1	3.2	3.2	3.4	3.4
Power Consumption	7.5	7.5	9.4	9.4	15	15
Band Attenuation	1520MHz: -20dB 1642MHz: -20dB		1520MHz: -20dB 1642MHz: -20dB		1520MHz: -20dB 1642MHz: -20dB	
Cable	3m RG-174 standard, fully customizable					
Connector	SMA(M) standard, fully customizable					

CELLULAR					
Frequency (MHz)	824 ~ 896	880 ~ 960	1710 ~ 1880	1850 ~ 1990	1710 ~ 2170
Peak Gain (dBi) *	3.4	3.2	3.8	3.0	3.8
Average Gain (dBi) *	1.2	1.5	0.4	-0.1	-0.2
Efficiency *	62%	50%	44%	38%	35%
Impedance	50 $\Omega$				
Polarization	Linear				
Radiation Pattern	Omnidirectional				
Cable	3m CFD200 standard, fully customizable				
Connector	SMA(M) standard, fully customizable				
Wi-Fi					
Frequency (GHz)	2.4~2.5	4.7 ~ 5.0	5.0 ~ 5.4	5.4 ~ 5.9	
Peak Gain (dBi) *	2.1	3.2	4.5	4.4	

A	1.4	2.5	3.2	1.75
Average Gain (dBi) *				
Efficiency *	57%	38%	42%	40%
VSWR	<=1.6:1			
Impedance	50Ω			
Polarization	Linear			
Radiation Pattern	Omni			
Cable	3m CFD200 standard, fully customizable			
Connector	RP-SMA(M) standard, standard, fully customizable			
<b>MECHANICAL</b>				
Dimensions	Height 50mm x Diameter 150mm			
Casing	UV resistant ABS			
Base and thread	Zinc			
Thread diameter	30mm			
Waterproof	IP67			
<b>ENVIRONMENTAL</b>				
Temperature Range	-40°C to 85°C			
Humidity	Non-condensing 65°C 95% RH			

\* Including 3 meters cable loss

### 3. GPS/GLONASS/GALILEO Antenna

#### Characteristics

##### 3.1. Block diagram

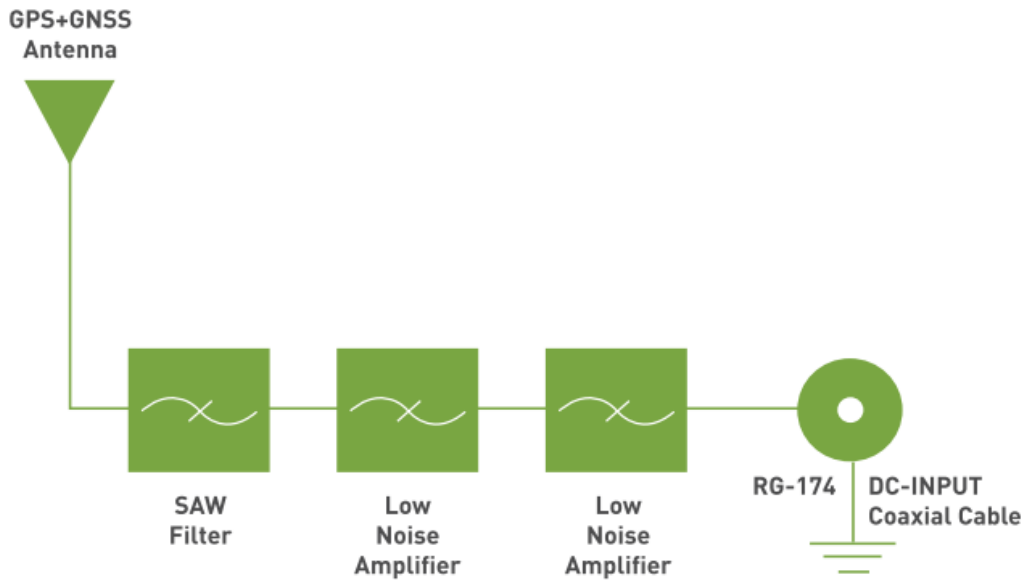

##### 3.2. Return Loss

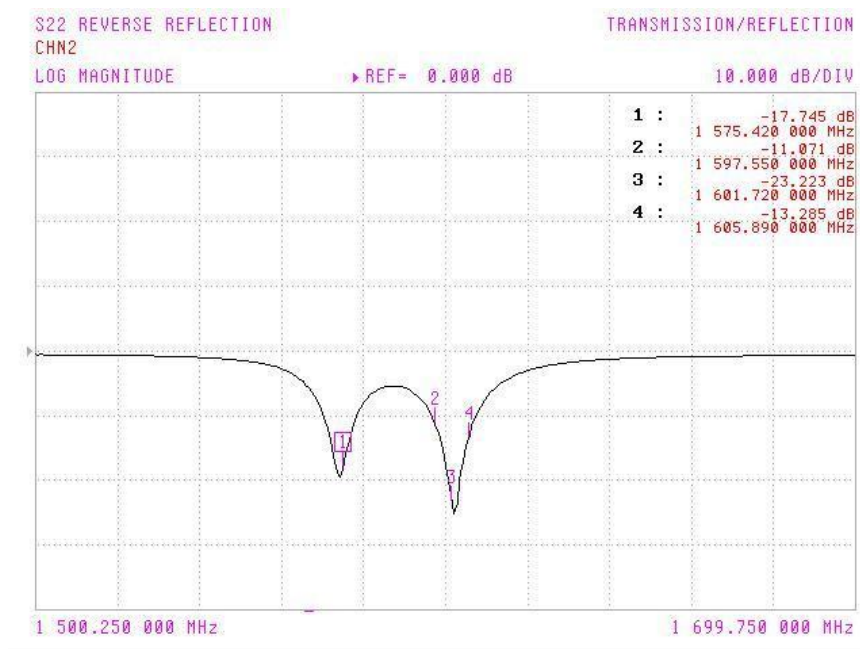

### 3.3. GPS/GLONASS/GALILEO Antenna Radiation Pattern



MA.600 tested in CTIA approved 3D chamber

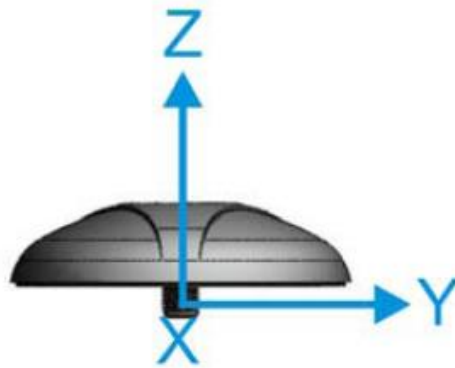

XYZ co-ordinate for reference.

### 3.4. Radiation Pattern

XZ Plane Free Space @1575.42MHz

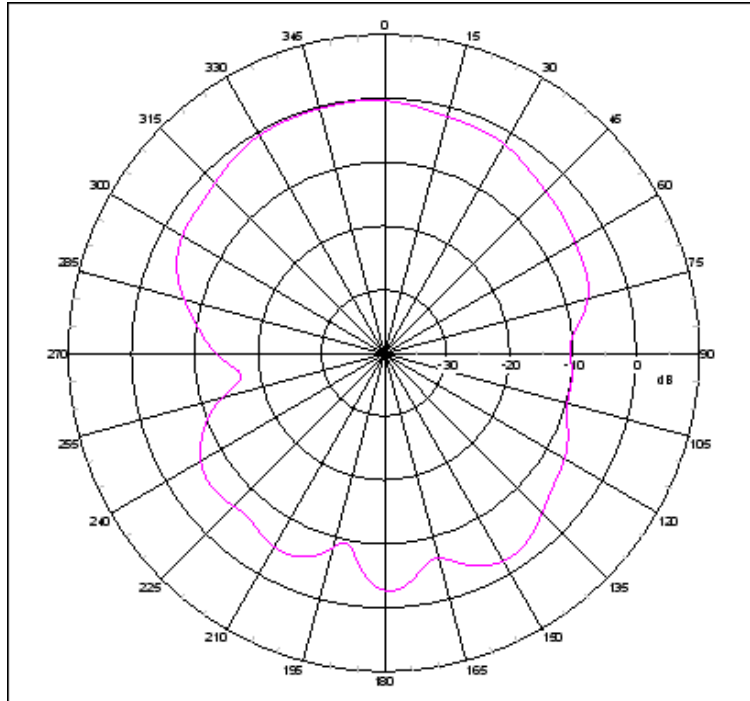

YZ Plane Free Space @1575.42MHz

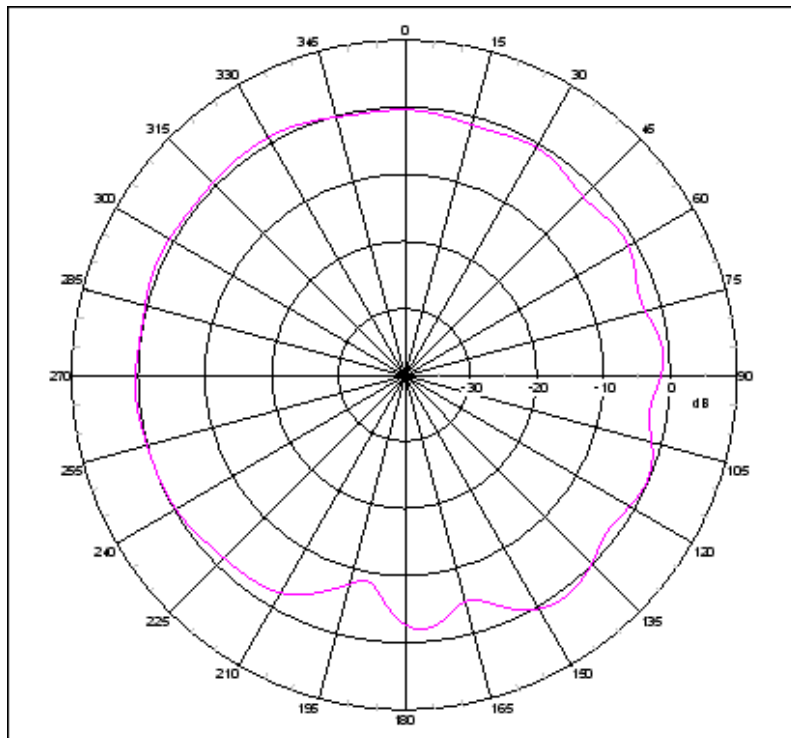



XZ Plane Free Space @1602MHz

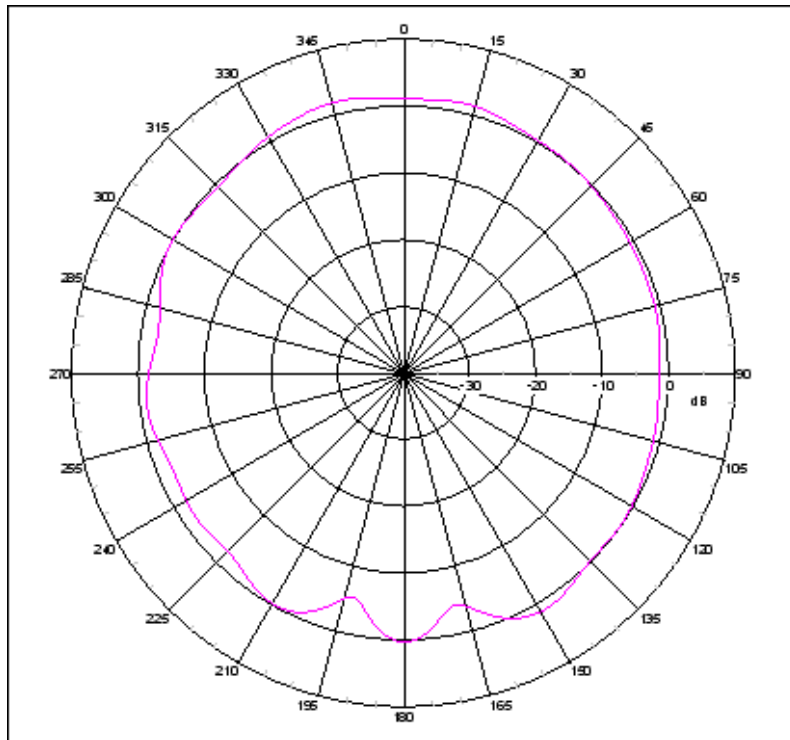

YZ Plane Free Space @1602MHz

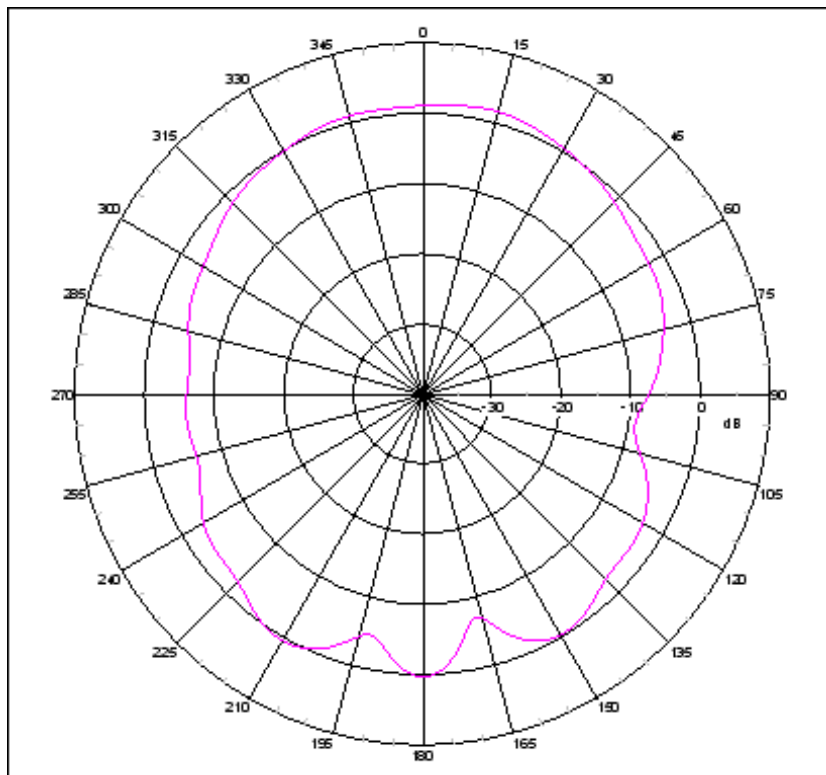

### 3.5. GPS/GLONASS/GALILEO LNA

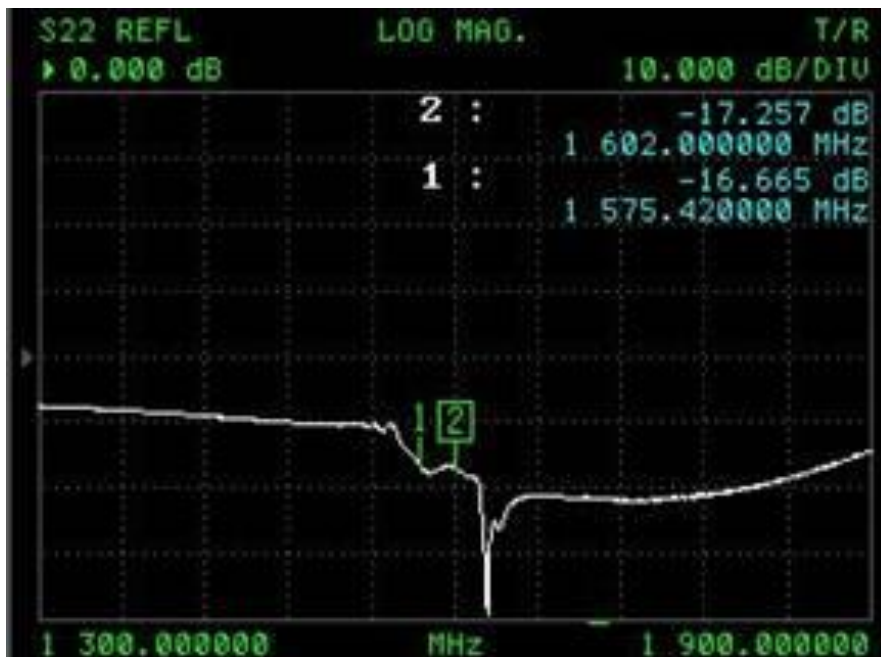
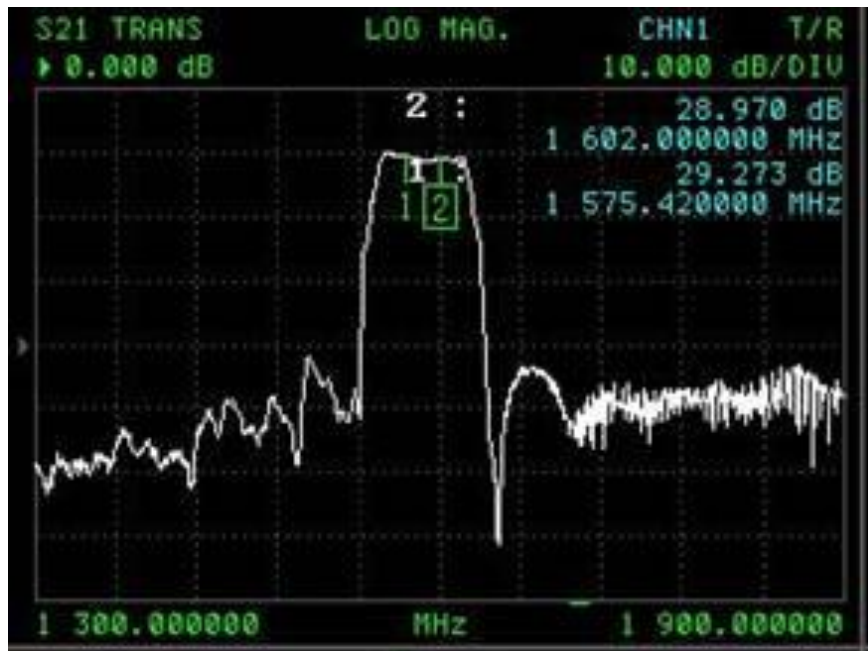

## 4. Cellular Antenna Characteristics

### 4.1. Return Loss

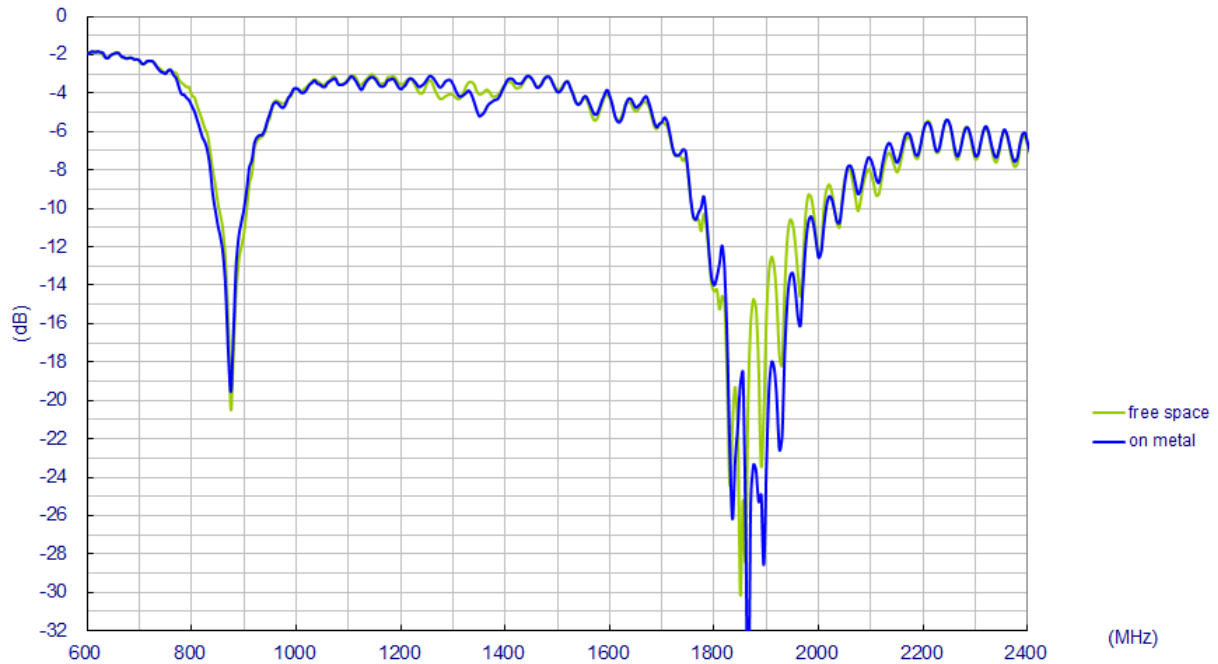

### 4.2. VSWR

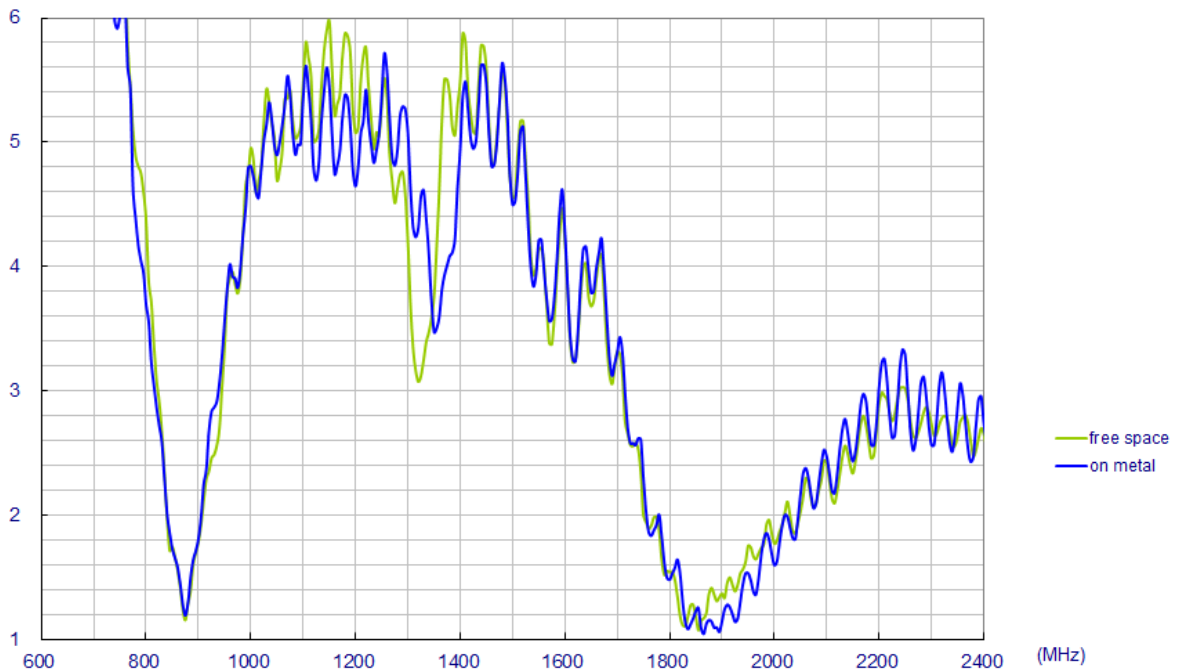

### 4.3. Cellular Antenna Efficiency

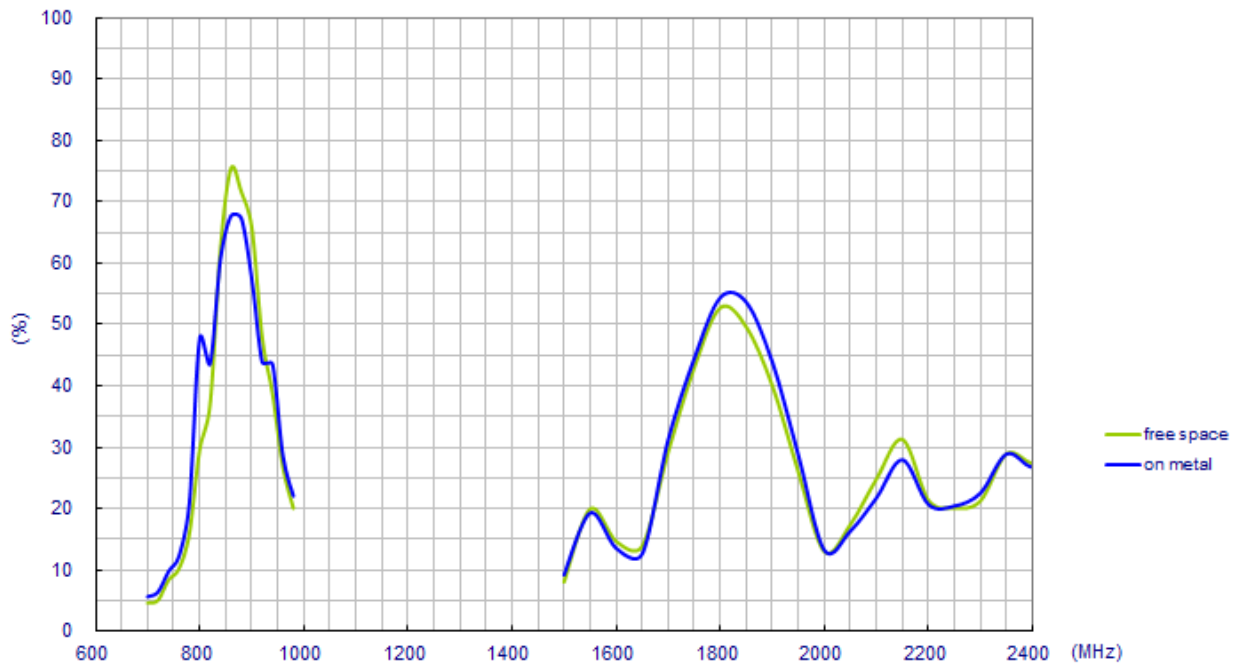

### 4.4. Cellular Antenna Peak Gain

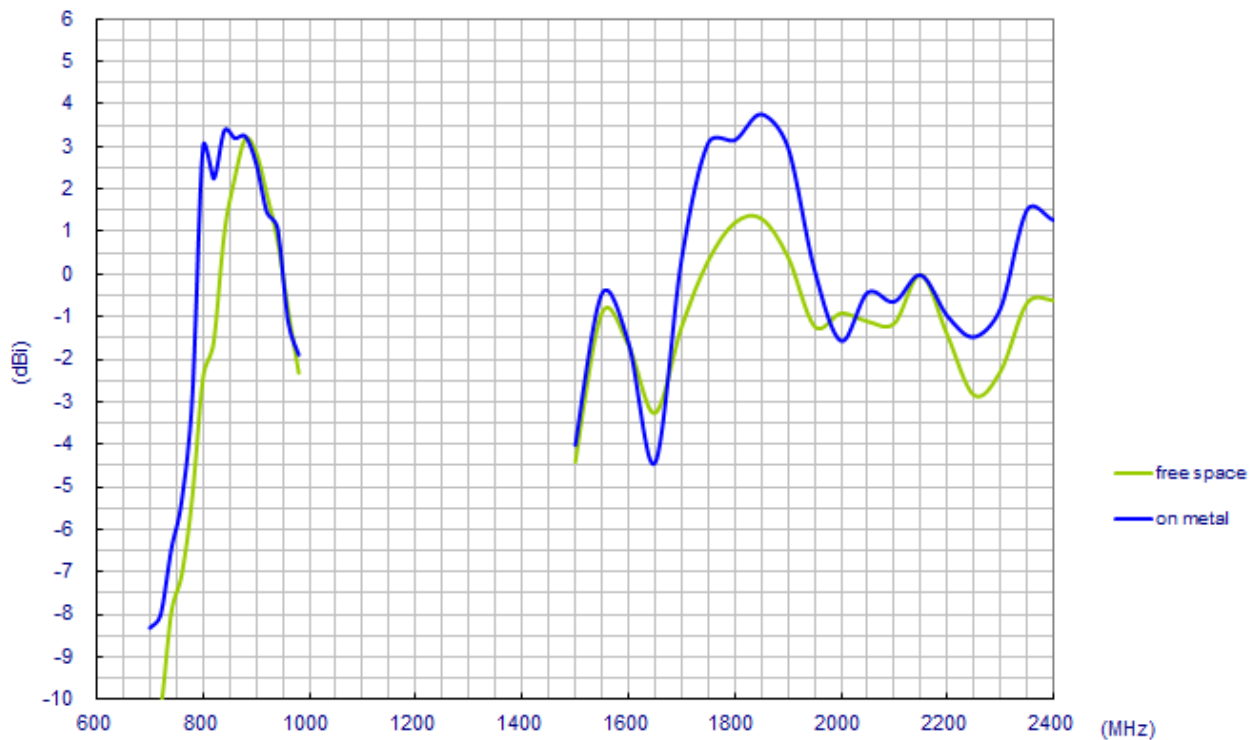

### 4.5. Cellular Antenna 3D Average Gain

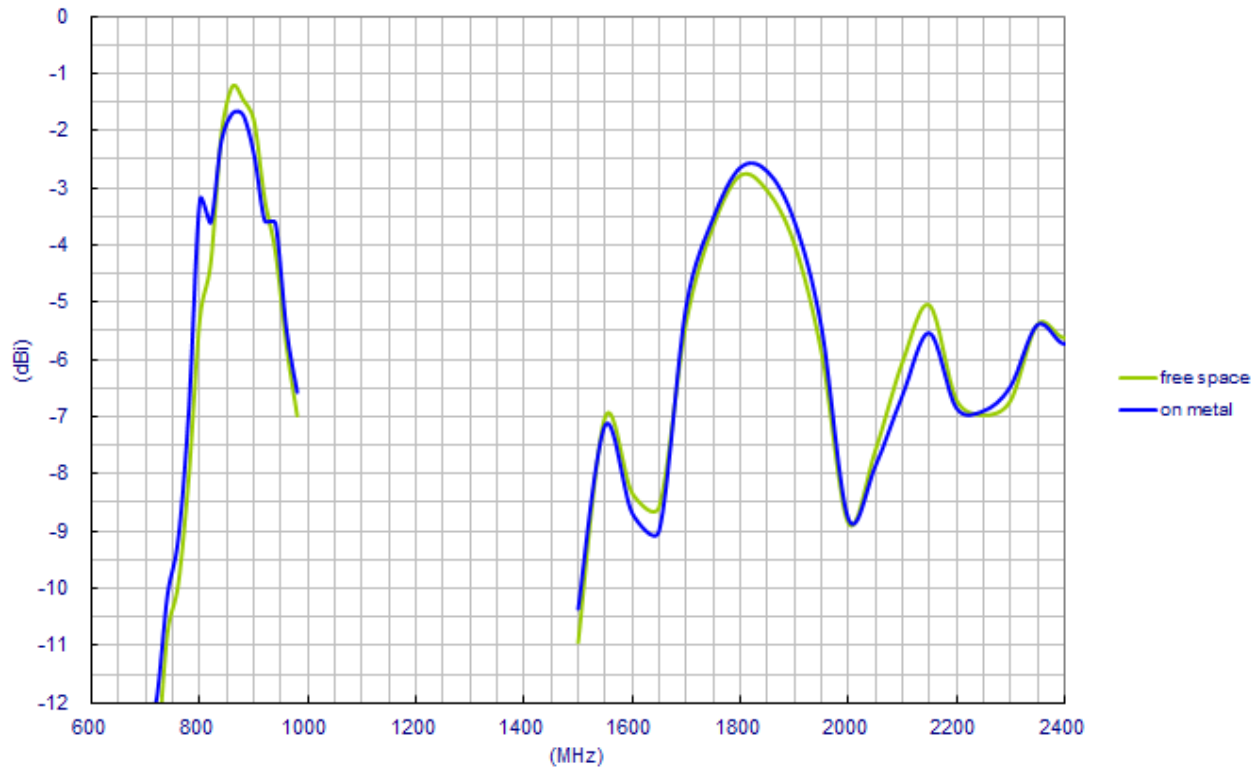

## 4.6. Cellular Antenna Radiation Pattern in Free Space

XY Plane

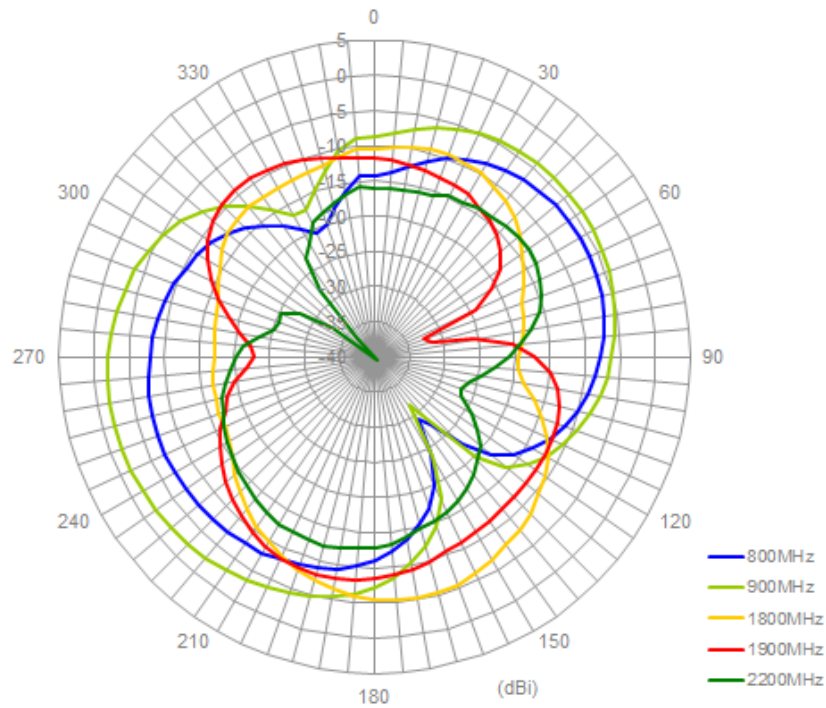

XZ Plane

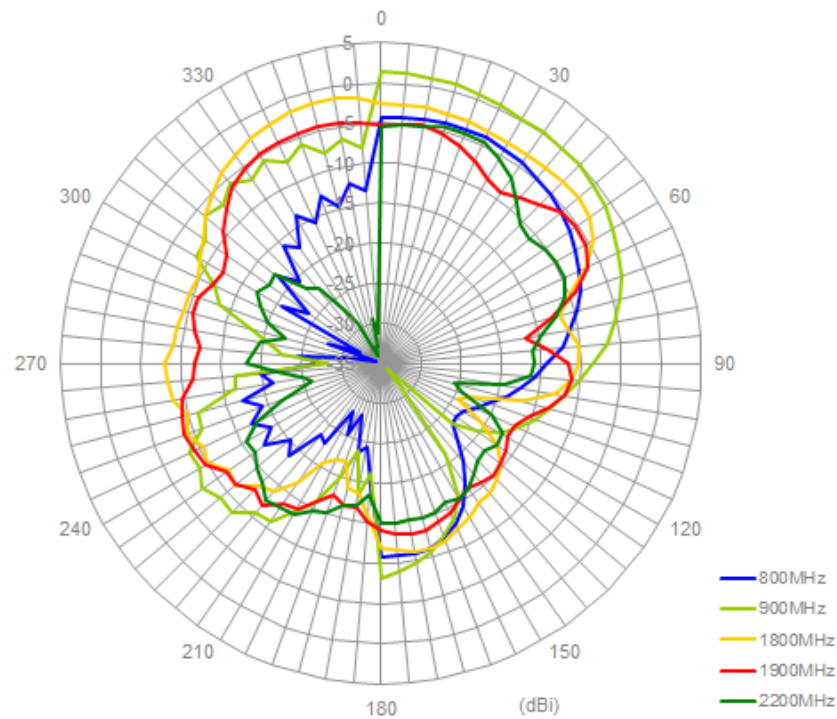

## 4.7. Cellular Antenna Radiation Pattern on Metal ground plane

XY Plane

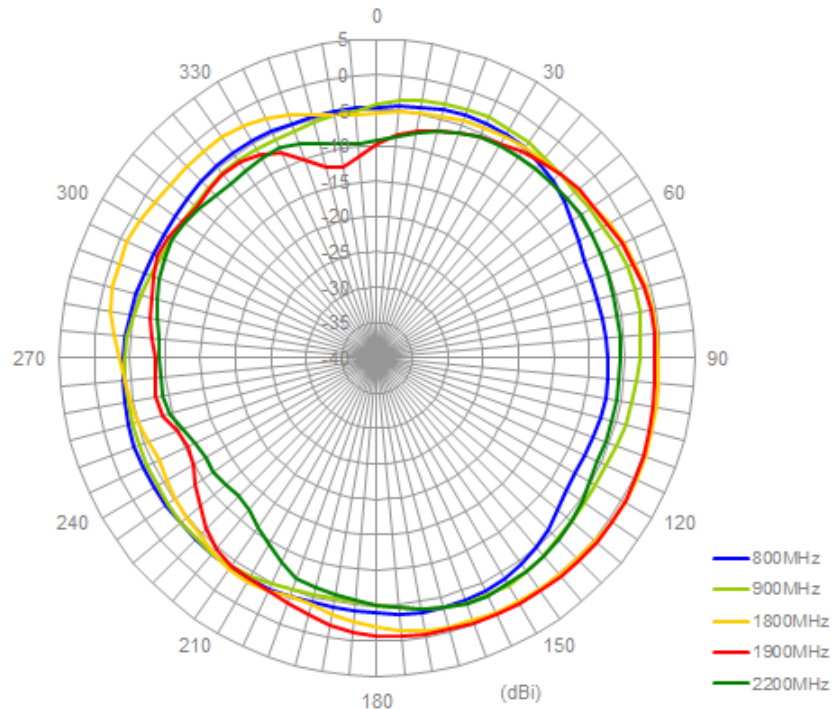

XZ Plane

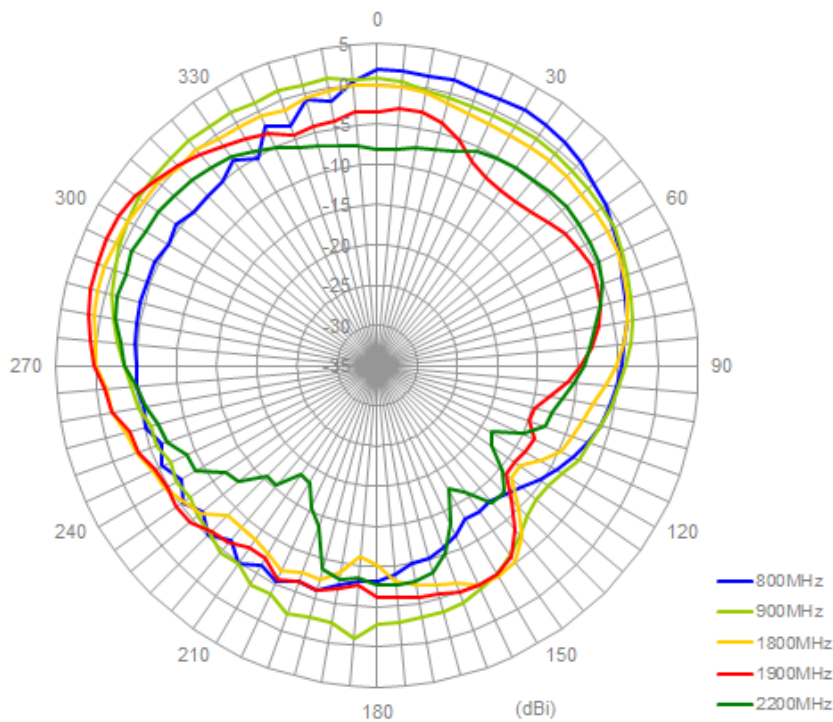

## 5. 2.4/5.8GHz Antenna Characteristics

### 5.1. Return Loss

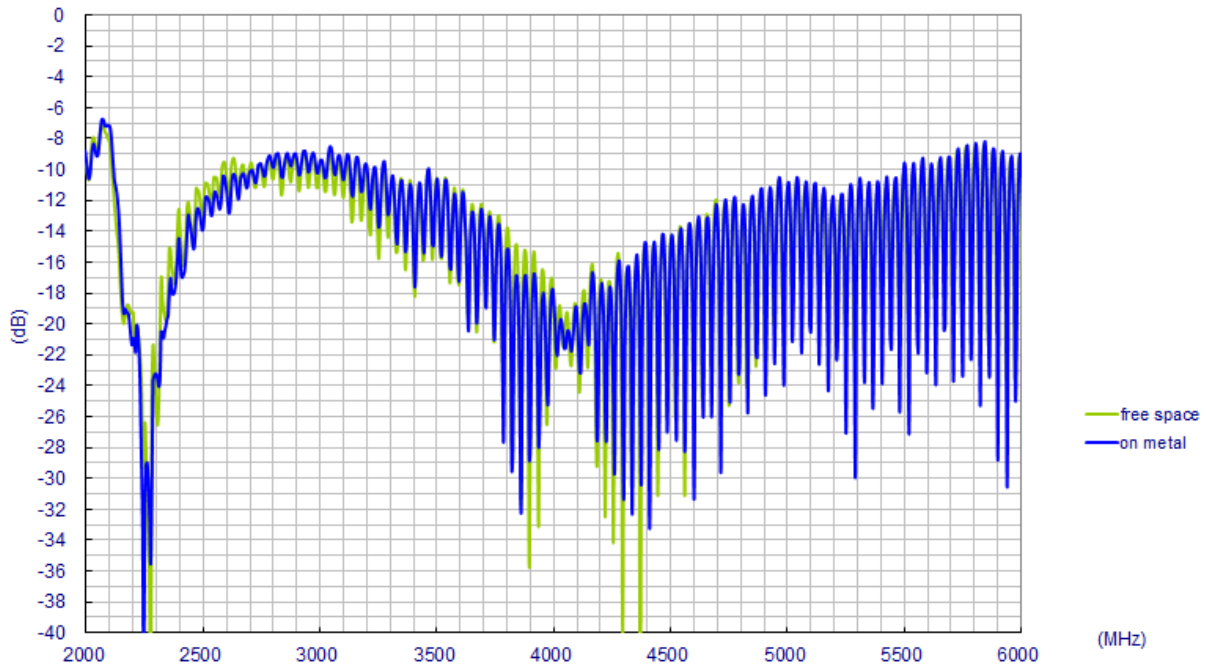

### 5.2. VSWR

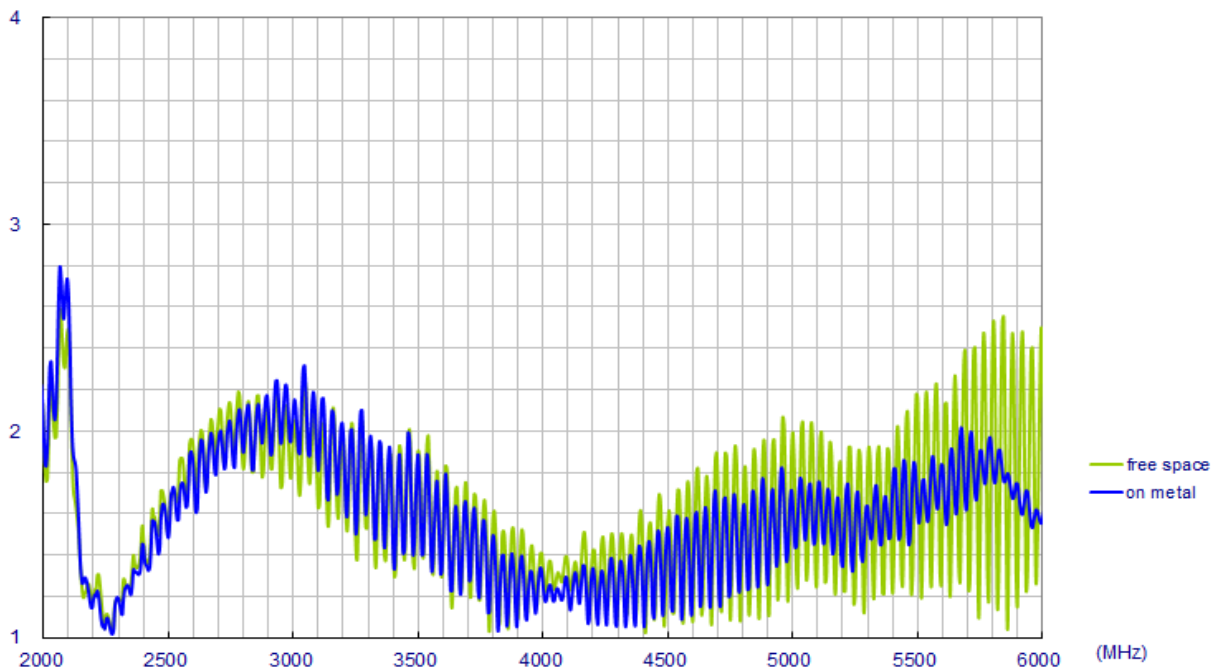



### 5.3. 2.4/5.8GHz Antenna Efficiency

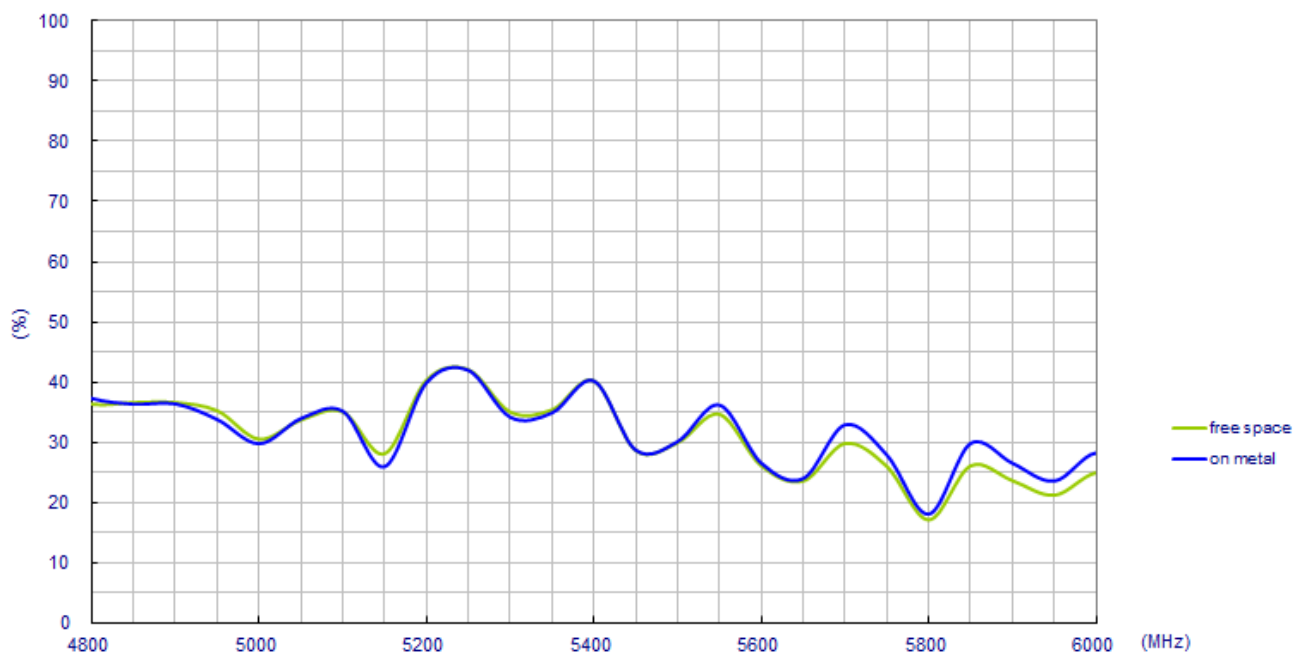
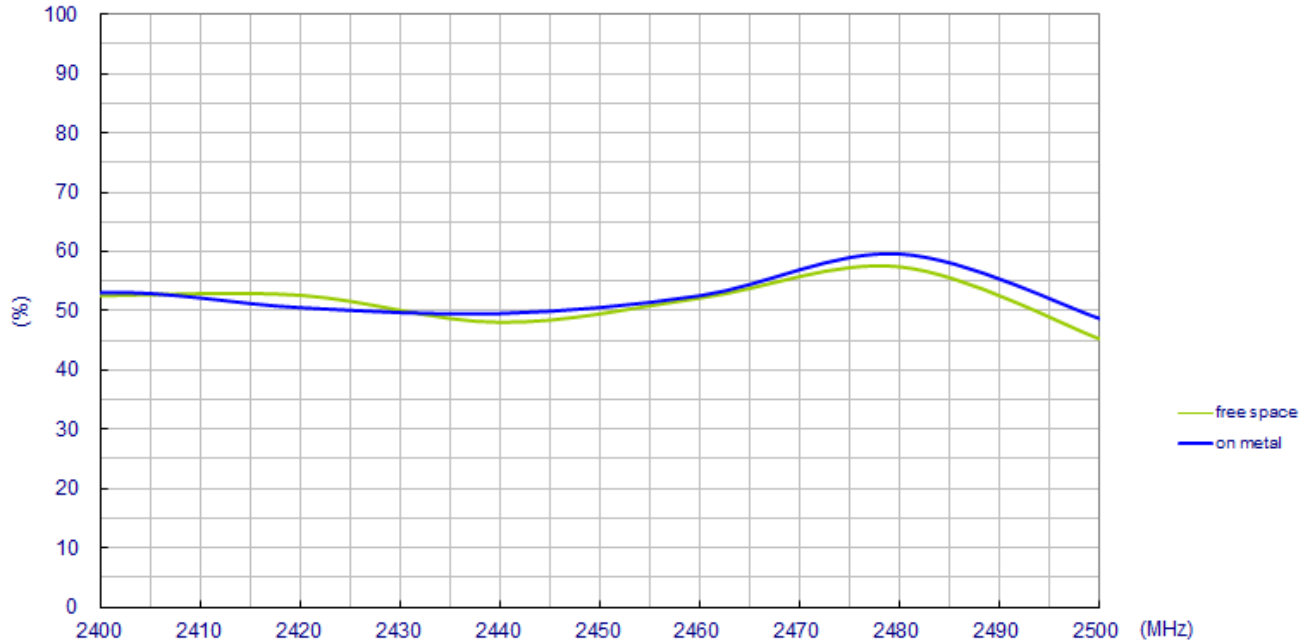

### 5.4. 2.4/5.8GHz Antenna Peak Gain

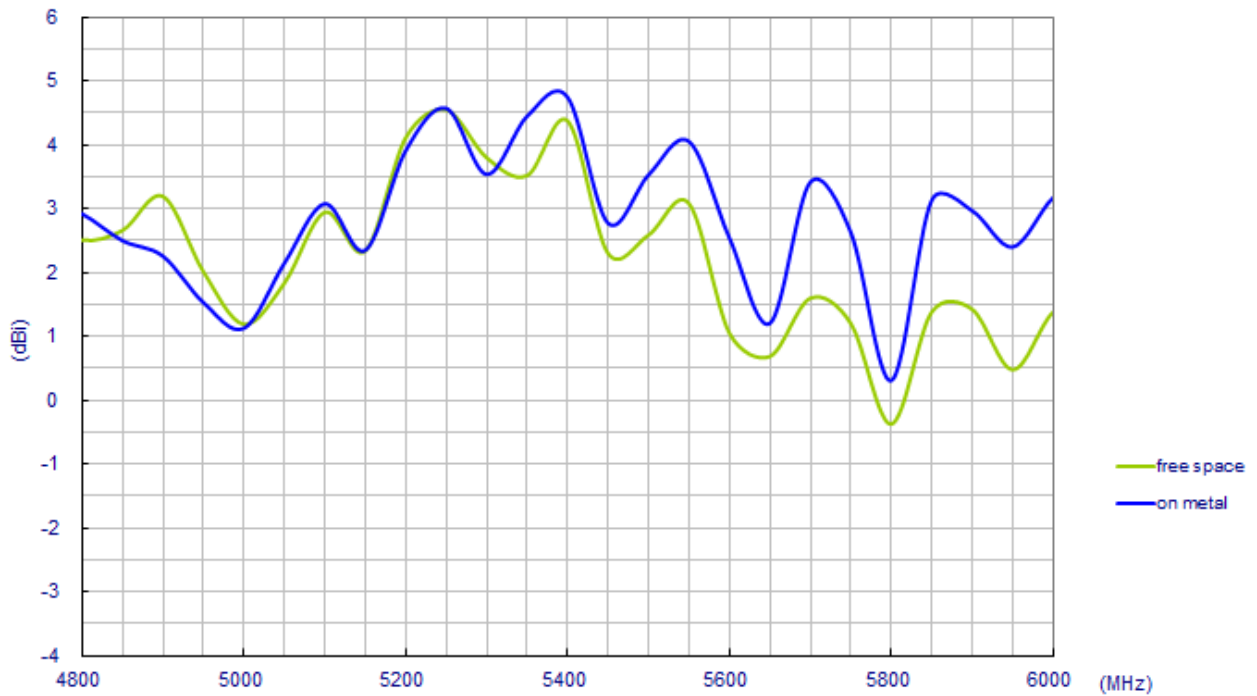
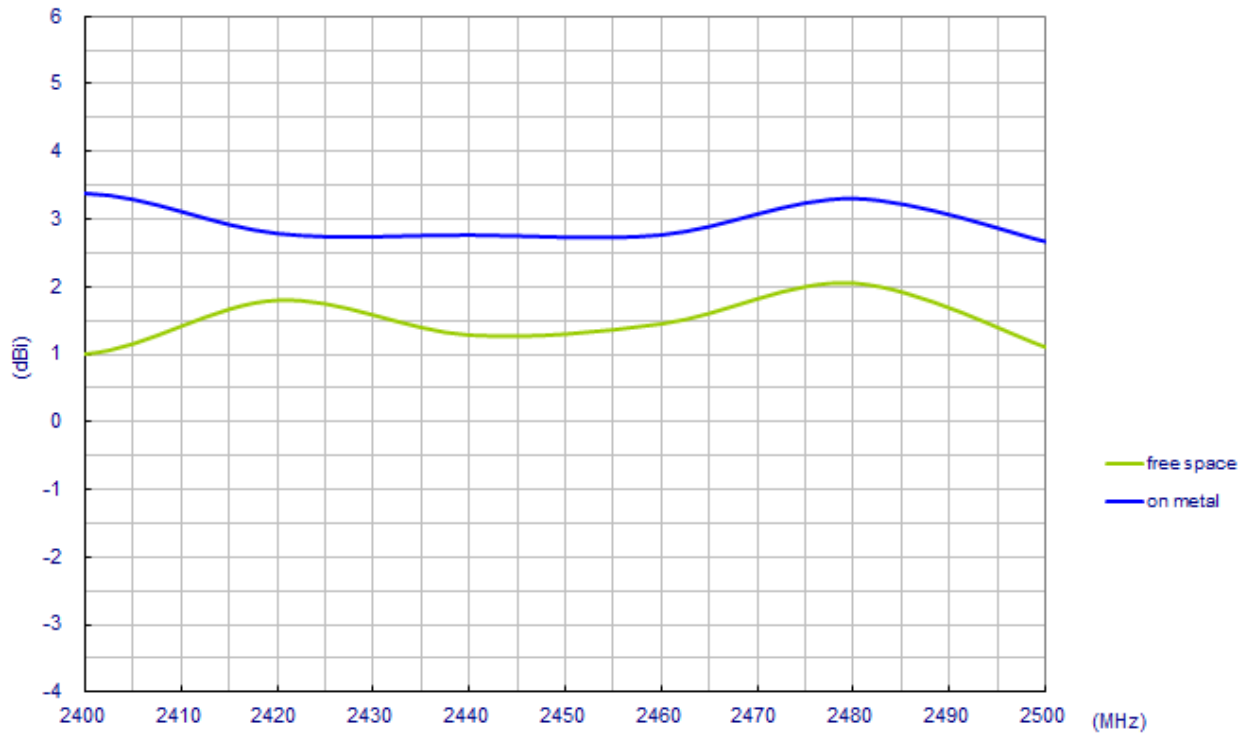

### 5.5 2.4/5.8GHz Antenna 3D Average Gain

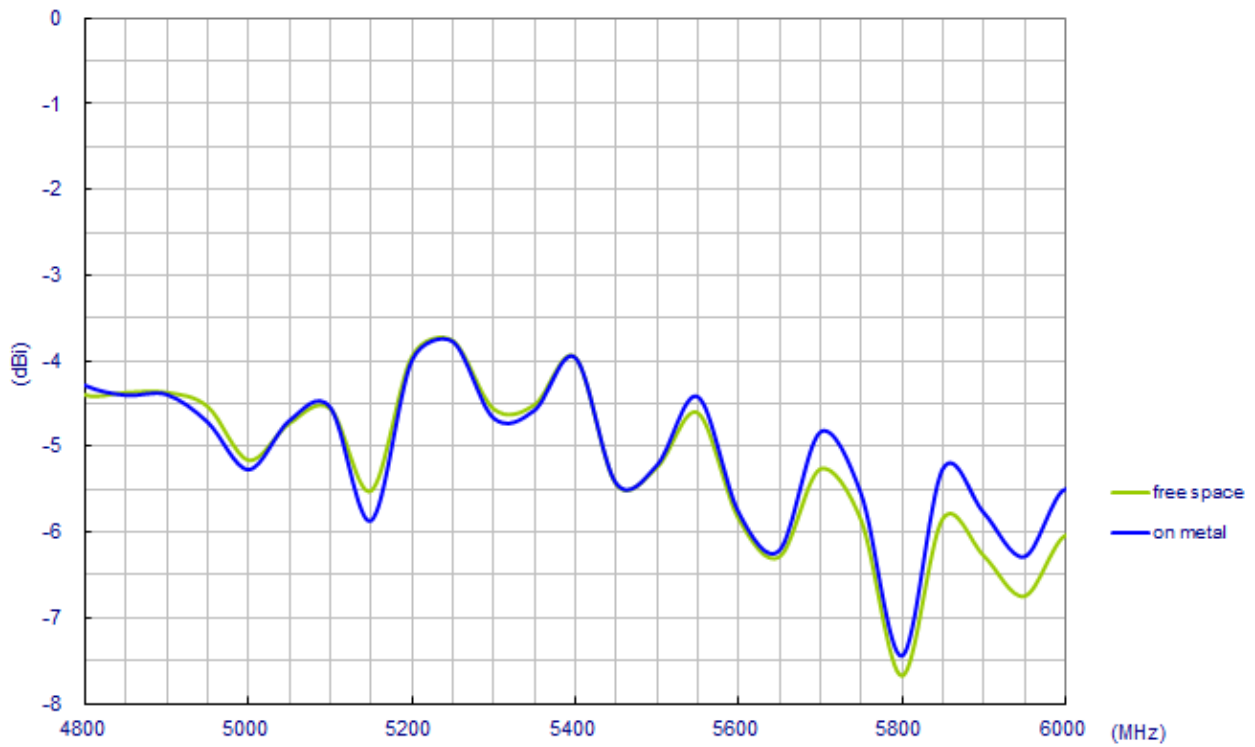
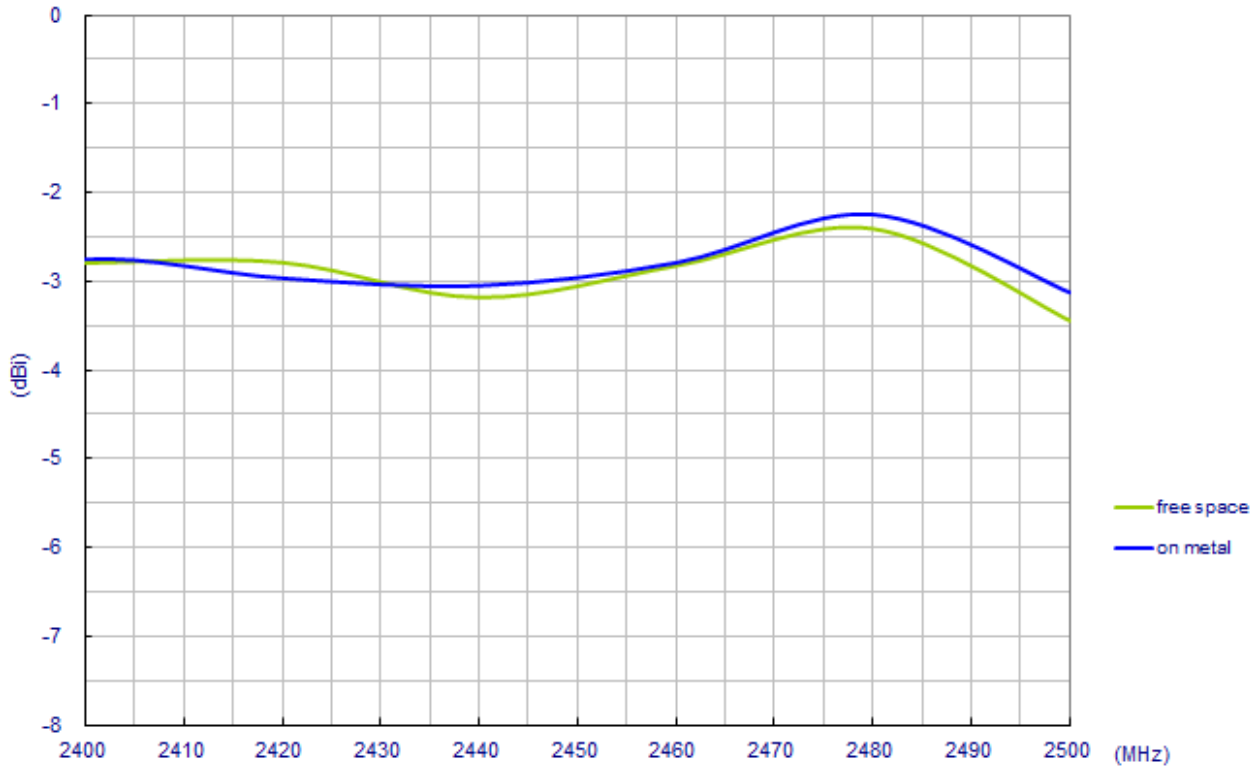

## 5.6 2.4/5.8GHz Antenna Radiation Pattern in Free Space

XY Plane

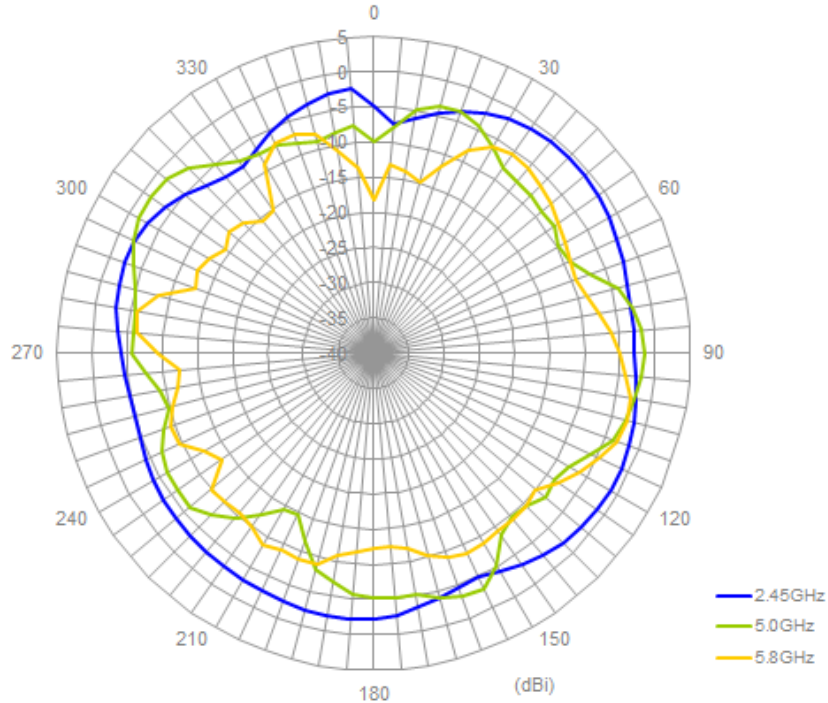

XZ Plane

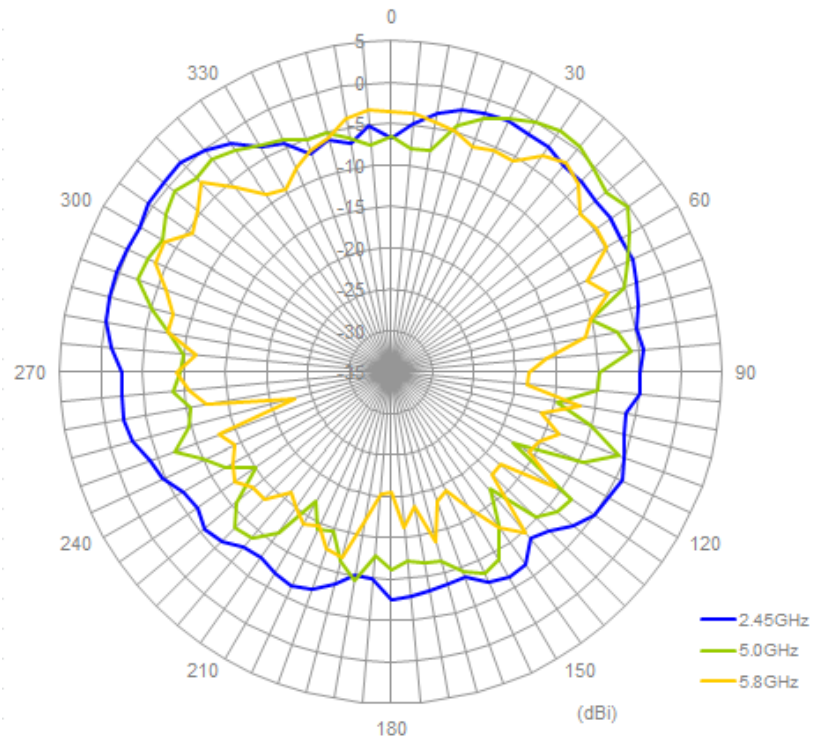

## 5.7 2.4/5.8GHz Antenna Radiation Pattern on Metal ground plane

XY Plane

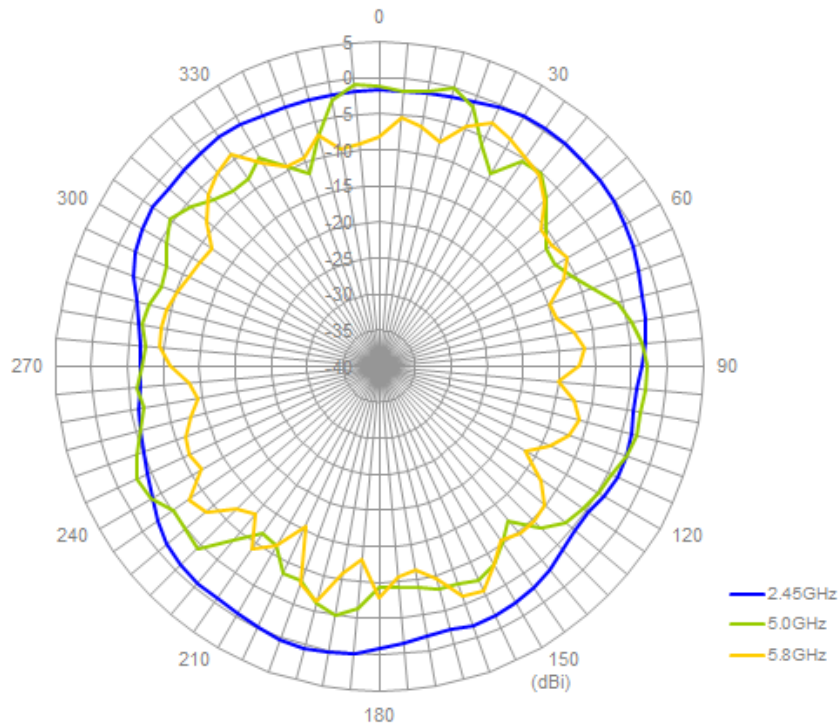

XZ Plane

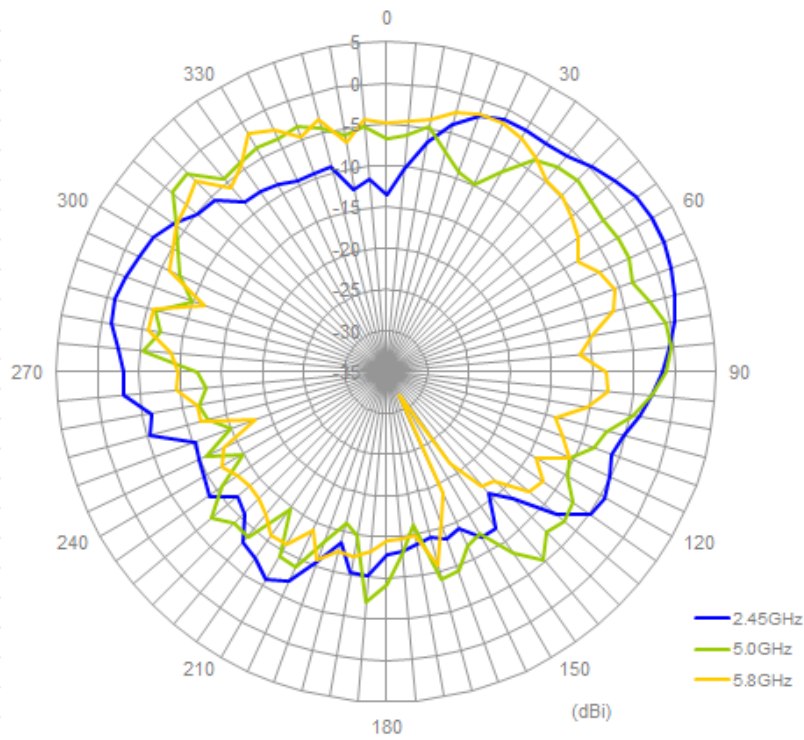

## 6. Mechanical Drawing

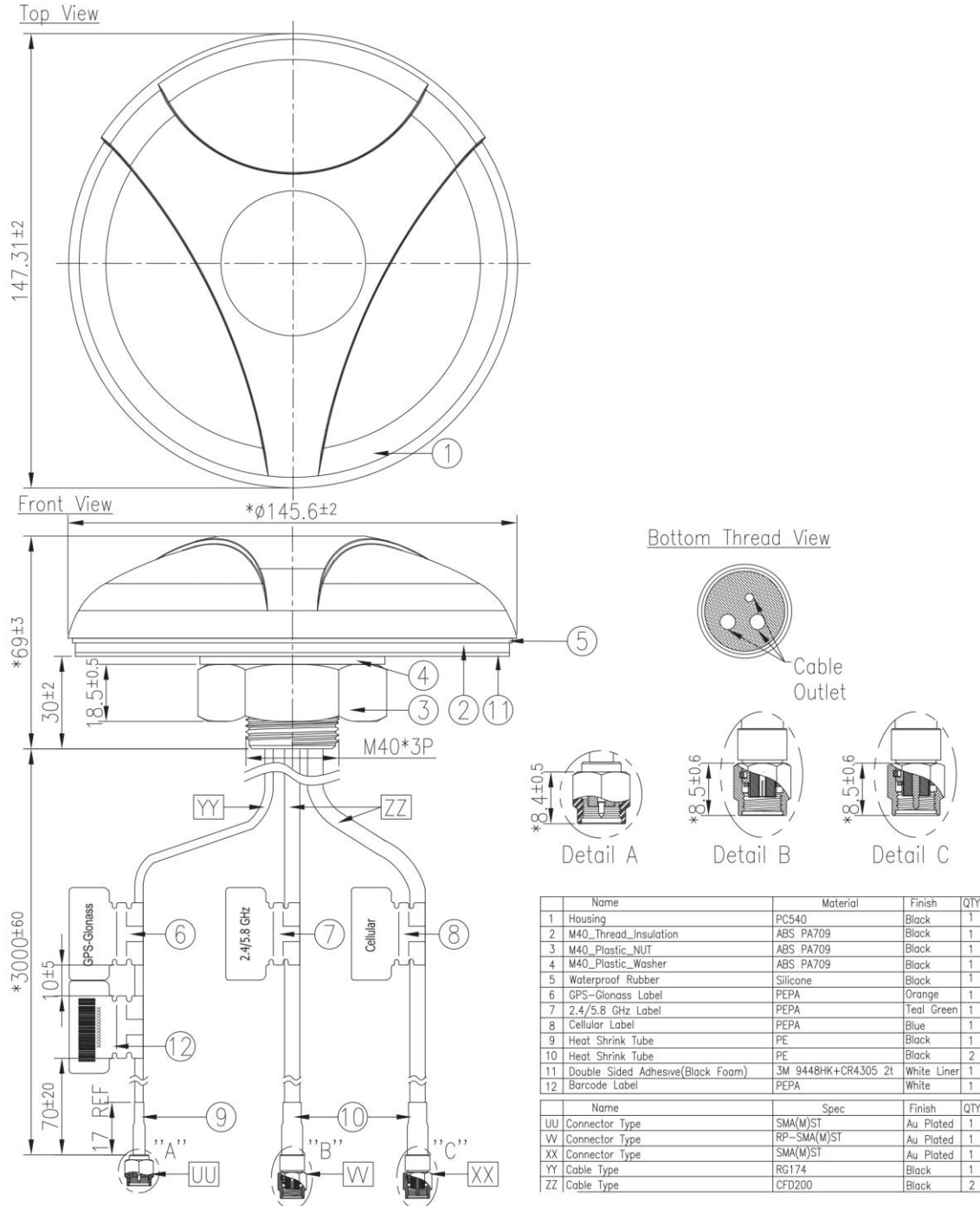

## 7. Installation

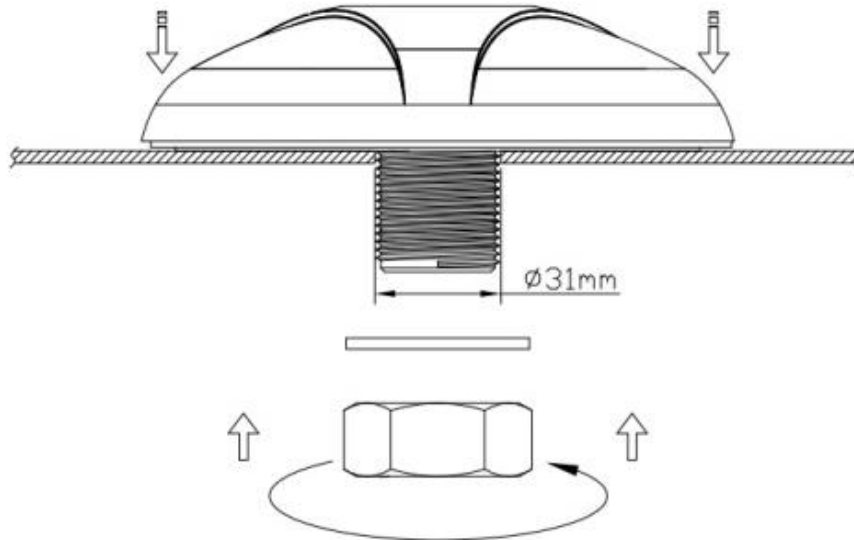

Recommended Torque for Mounting 49 N·m  
 Maximum Torque for Mounting 58.8 N·m

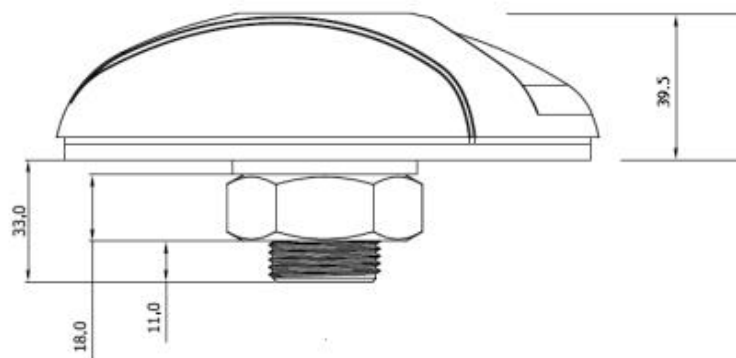

**Thread  
 Diameter**

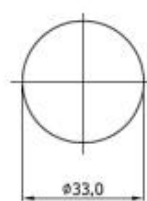

**Recommended  
 Mounting Hole**

## 8. Packaging

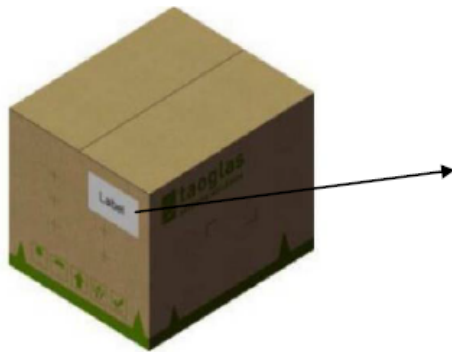
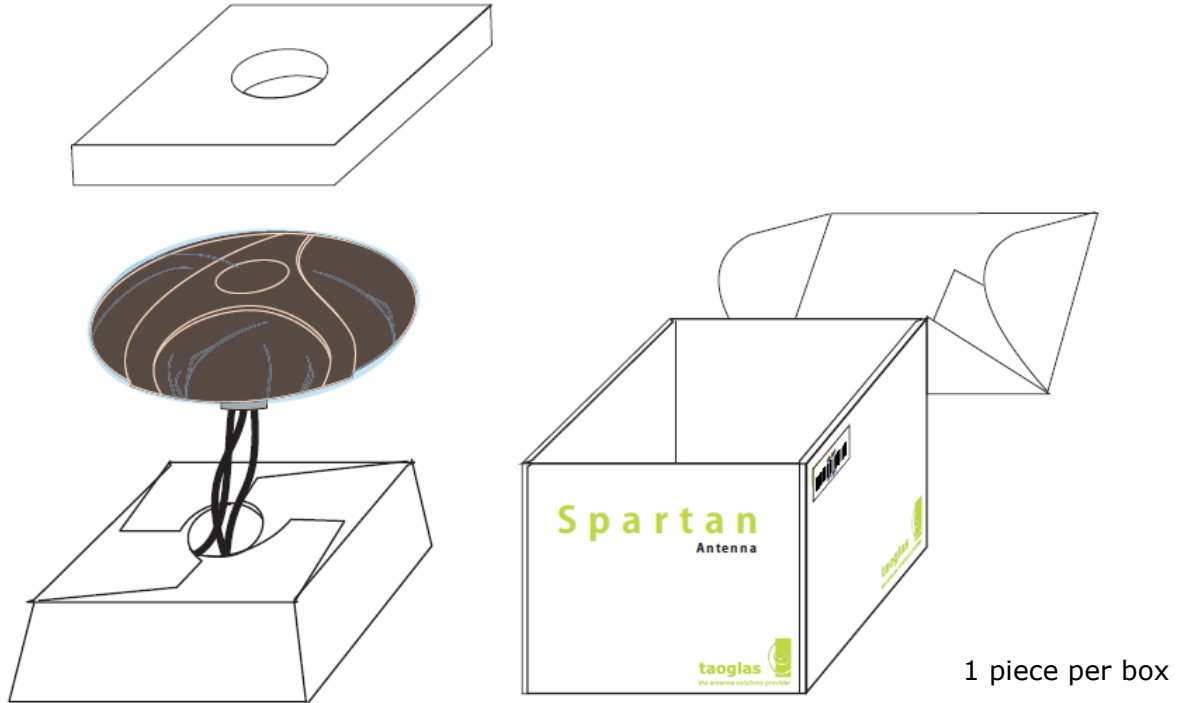

8PCS per carton  
(384\*350\*300mm)





Taoglas makes no warranties based on the accuracy or completeness of the contents of this document and reserves the right to make changes to specifications and product descriptions at any time without notice. Taoglas reserves all rights to this document and the information contained herein.

Reproduction, use or disclosure to third parties without express permission is strictly prohibited.

Copyright © Taoglas Ltd.