



# TAOGLAS®



# Datasheet

## Taoglas Invisible Antenna™

**Part No:**  
TFX125.B

### Description

TFX125.B – Multiband GNSS Invisible Antenna

### Features:

Multiband GNSS  
Transparent Polymer Antenna  
Dimensions: 176mm\*37mm  
Connector: SMA (F)  
RoHS & Reach Compliant

<b>1.</b>	<b>Introduction</b>	<b>3</b>
<b>2.</b>	<b>Specification</b>	<b>4</b>
<b>3.</b>	<b>Mechanical Drawing</b>	<b>6</b>
<b>4.</b>	<b>Packaging</b>	<b>7</b>
<b>5.</b>	<b>Antenna Characteristics</b>	<b>8</b>
<b>6.</b>	<b>Radiation Patterns</b>	<b>12</b>
<hr/>		
	Changelog	18

Taoglas makes no warranties based on the accuracy or completeness of the contents of this document and reserves the right to make changes to specifications and product descriptions at any time without notice. Taoglas reserves all rights to this document and the information contained herein. Reproduction, use or disclosure to third parties without express permission is strictly prohibited.

Ireland & USA  
ISO 9001:2015  
Certified



Taiwan  
ISO 9001:2015  
Certified



# 1. Introduction



The TFX125.B is a first of its kind, invisible antenna designed to cover multi GNSS bands. The TFX125.B has been expertly engineered by Taoglas with innovation in mind, the design is based on our excellent design history in pioneering flexible PCB antenna technology. TFX125.B is supplied with pre adhered adhesive for ease of installation and has an enclosed carrier terminated with a SMA connector.

The invisible flexible antennas are an alternative to standard Flexible PCB antennas where the user may want to install an antenna in a covert area or on a surface, they may want to keep visible. The performance of the antenna is based on the environment where it is placed, care should be taken to mount at least 20mm from metal components where possible.

Typical Applications Include:

- Automotive and Commercial Transportation
- EV Charging and Parking Bays
- Digital Signage and Display screens
- Point Of Sale Kiosks

The installation of the Taoglas Invisible Antenna™ series follows a similar installation method to flexible PCB antennas. Installing a transparent material may show obvious flaws/debris, take care to wipe the area clean before adhering the antenna. The flexible antenna can be disconnected from the body to make installation easier. Where support may be an issue, we would advise using a double-sided adhesive on the housing to ensure the housing body installation does not add any additional pull force to the antenna as this will affect the antennas performance and the adhesive's performance. The feed is not designed to be load bearing and loads of over 0.5Kg can break or damage the feed resulting in the antenna disconnecting.

The TFX125.B is connected via a SMA female connector for ease of installation. If a custom connector is required, please contact your regional Taoglas customer support team.

## 2. Specification

GNSS Frequency Bands					
GPS	L1 1575.42 MHz	L2 1227.6 MHz	L5 1176.45 MHz		
	■	■	■		
GLONASS	G1 1602 MHz	G2 1248 MHz	G3 1207 MHz		
	■	■	■		
Galileo	E1 1575.24 MHz	E5a 1176.45 MHz	E5b 1201.5 MHz	E6 1278.75 MHz	
	■	■	■	■	
BeiDou	B1C 1575.42 MHz	B1I 1561 MHz	B2a 1176.45 MHz	B2b 1207.14 MHz	B3 1268.52 MHz
	■	■	■	■	■
L-Band	L-Band 1542 MHz				
	■				
QZSS (Regional)	L1 1575.42 MHz	L2C 1227.6 MHz	L5 1176.45 MHz	L6 1278.75e6	
	■	■	■	■	
IRNSS (Regional)	L5 1176.45 MHz				
	■				
SBAS	L1/E1/B1 1575.42 MHz	L5/B2a/E5a 1176.45 MHz	G1 1602 MHz	G2 1248 MHz	G3 1207 MHz
	■	■	■	■	■

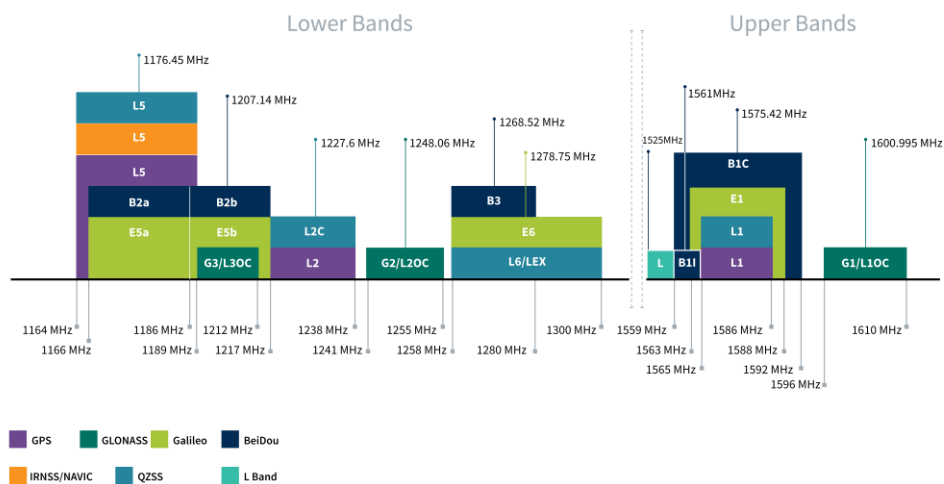

GNSS Bands and Constellations

GNSS Electrical						
Frequency (MHz)	1176.45	1227.6	1278.75	1561	1575.42	1603
VSWR (max.)	4:1	3:1	3:1	1:1	1:1	1:1
Efficiency (%)	21.74	29.34	38.29	37.48	36.4	35.05
Gain (dBic)	-7.36	-5.23	-3.74	-6.41	-6.41	-7.33
Polarization	Linear					
Impedance	50 $\Omega$					

Mechanical	
Dimensions	176 x 37mm
Weight	5g
Material (Housing)	ABS/PC
Material (Antenna)	PET
VLT (Visible Light Transmission)	78.1% TCF (Transparent Conductive Film)
Connector	SMA(F)

Environmental	
Operation Temperature	-40°C to 85°C
Storage Temperature	-40°C to 85°C
Relative Humidity	Non-condensing 65°C 95% RH

# 3. Mechanical Drawing

ISO NO.: EDW.002458  
 STATE: RELEASE  
 NOTES: 1.ALL MATERIAL MUST BE ROHS COMPLIANT.

REVISIONS				
REV.	DESCRIPTION	DATE	ENGINEER	APPROVED
D01	FIRST ISSUE	02MAY2024	SC	WL

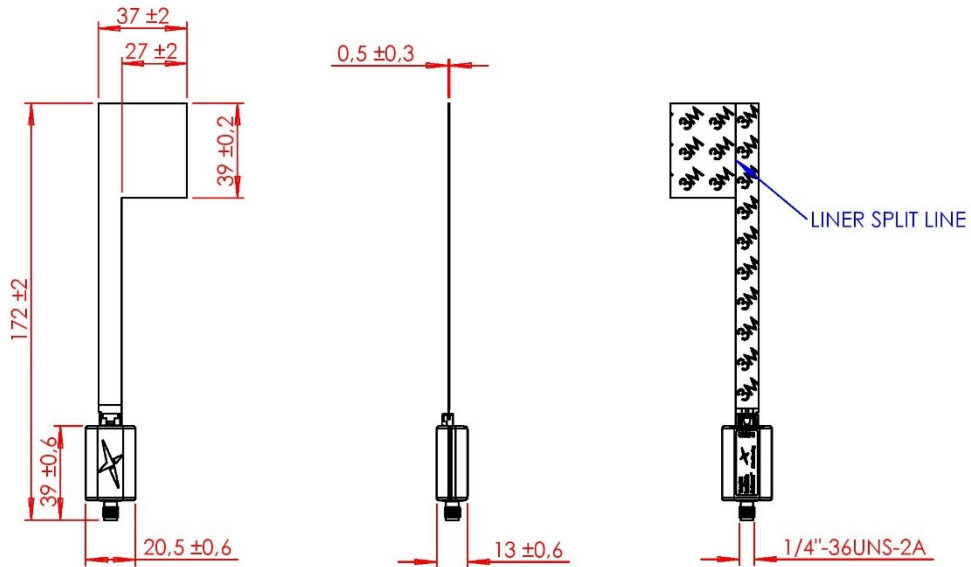

ITEM NO.	DESCRIPTION	MATERIAL	FINISH	QTY
1	TRANSPARENT FLEX GNSS ANTENNA	PET	CLEAR	1
2	FPC-to-BOARD CONNECTOR ADAPTOR 2 CONTACT	LCP	BLACK	1
3	ANTENNA PCB HOUSING	ABS/PC	BLACK	1
4	SMA(F) CONNECTOR	BRASS	GOLD	1
5	ADHESIVE + LINER	ADHESIVE	BROWN LINER	1
6	PATENT PENDING LABEL	PET	GLOSS	1

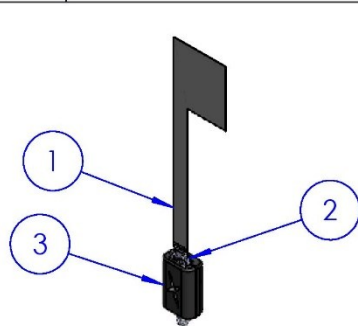

MODEL VIEW  
SCALE 1:3

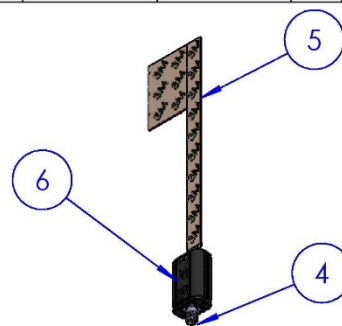

MODEL VIEW  
SCALE 1:3

APPROVED BY: NW	 <small>EHEA Design Centre</small> <small>This drawing and its inherent design concepts are property of Taoglas. Not to be copied or given to third parties without the written consent of Taoglas.</small>			
CHECK BY: WL				
DRAWN BY: SC				
DATE: 02MAY2024				
UNLESS OTHERWISE SPECIFIED TOLERANCES ON: <small>XXX.0 ±0.2</small> <small>XXX.3 ±0.3</small> <small>XXX.7 ±0.2</small> <small>XXX.1 ±0.1</small> <small>XXX.0 ±0.05</small>	TITLE: Transparent Flex Multiband GNSS Antenna w/connector and SMA(F) Connector			
THIRD ANGLE PROJECTION	PART NO.: TFX125.B			
	UNIT: mm	SCALE: 2:5	PAGES: 1/1	REV: D01

## 4. Packaging

1 PCS / Blister Box  
 Box: 216.6 x 84.5 x 19.3  
 Weight: 34g

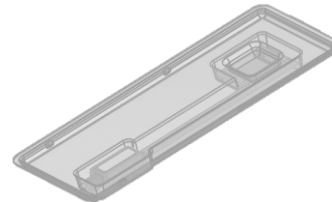

18 PCS / Column



216 PCS / Carton  
 1 SET / Partition board  
 Carton: 740 x 370 x 300mm  
 Carton Label  
 Weight: 9.42Kg

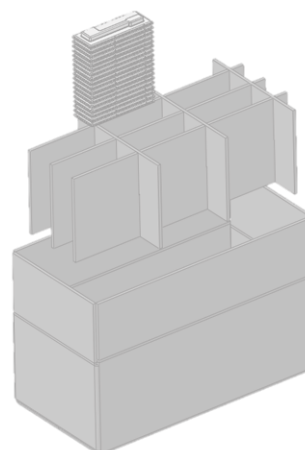

## 5. Antenna Characteristics

### 5.1 Test Setup

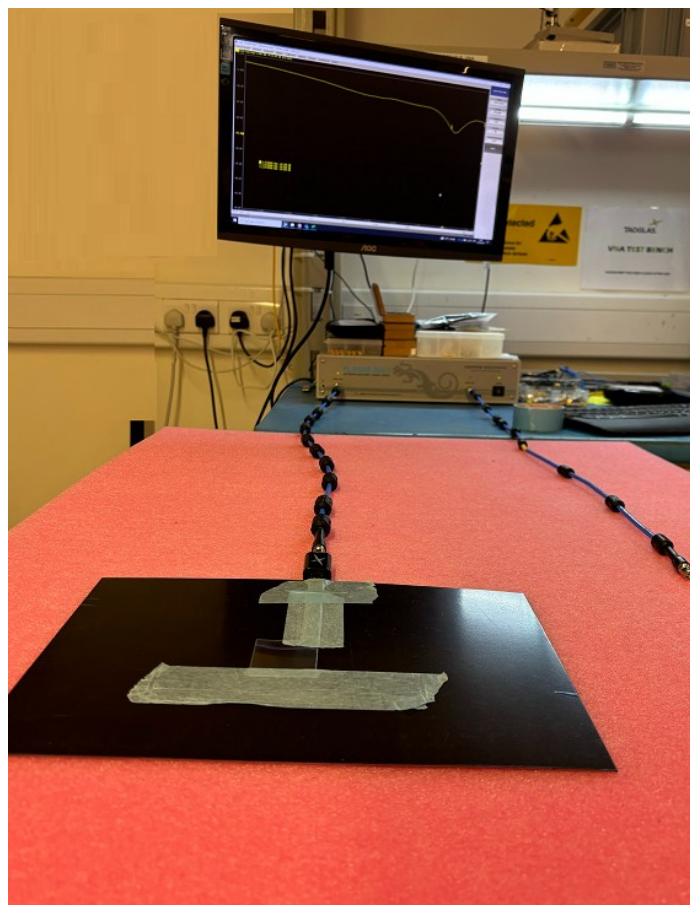
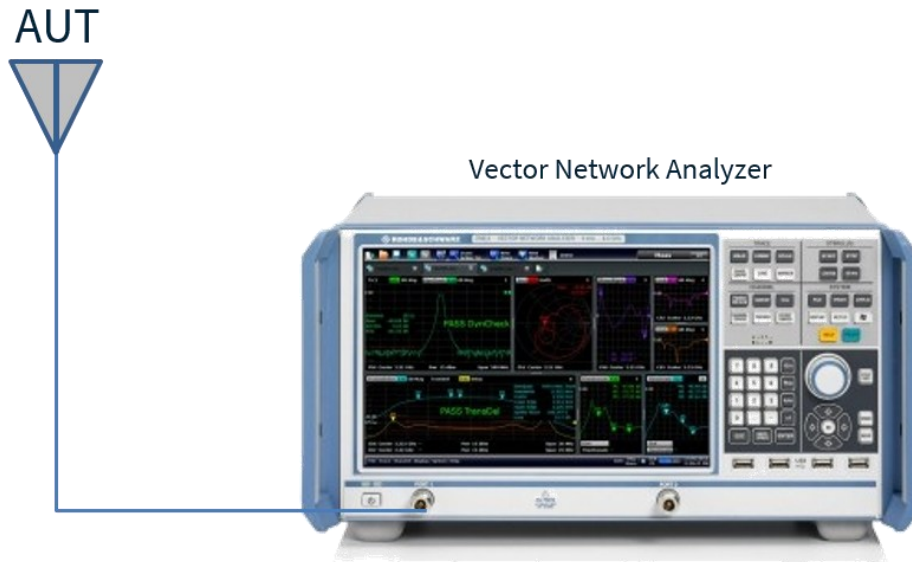

VNA Test Set-up



## 5.2 Return Loss

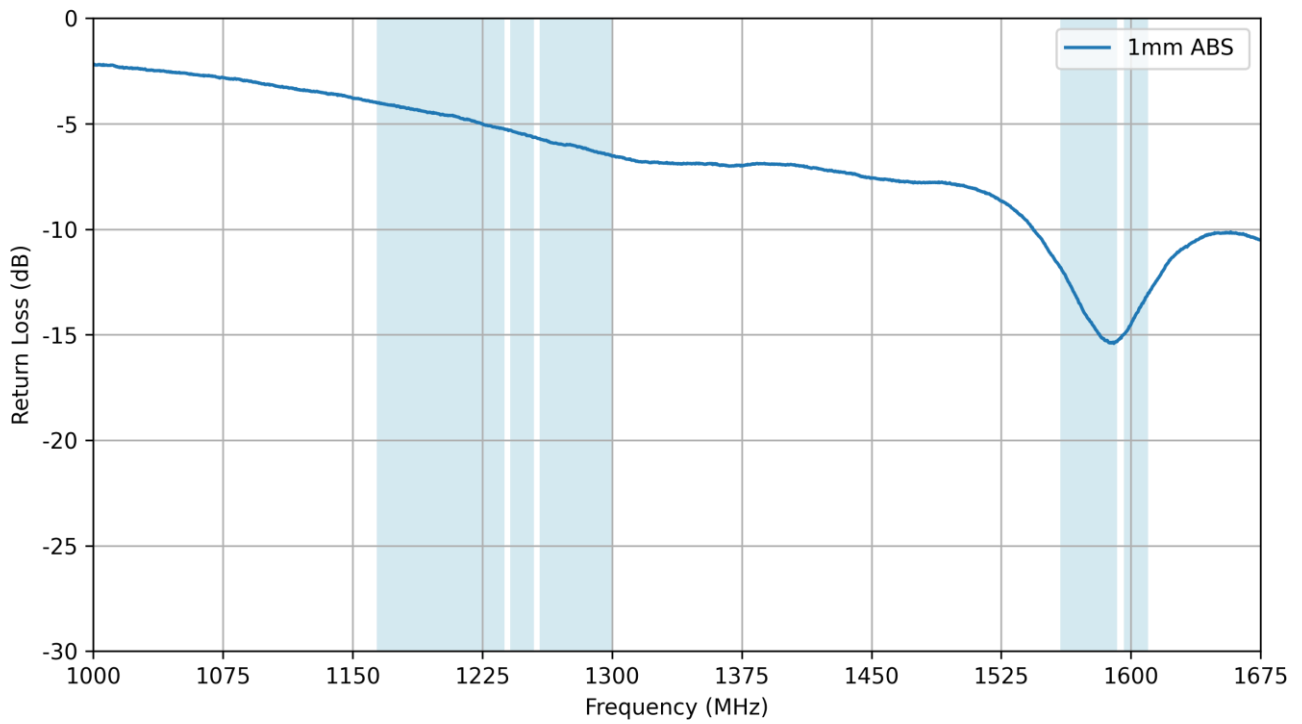

## 5.3 VSWR

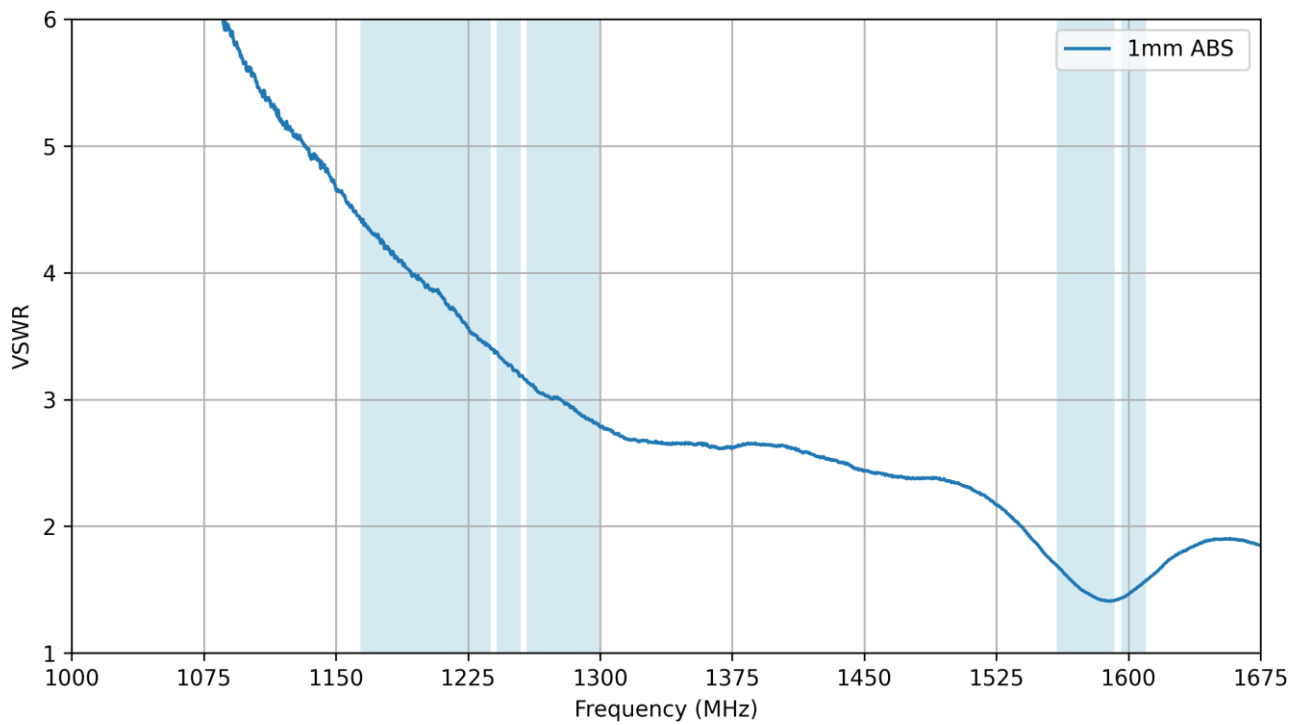

## 5.4 Efficiency

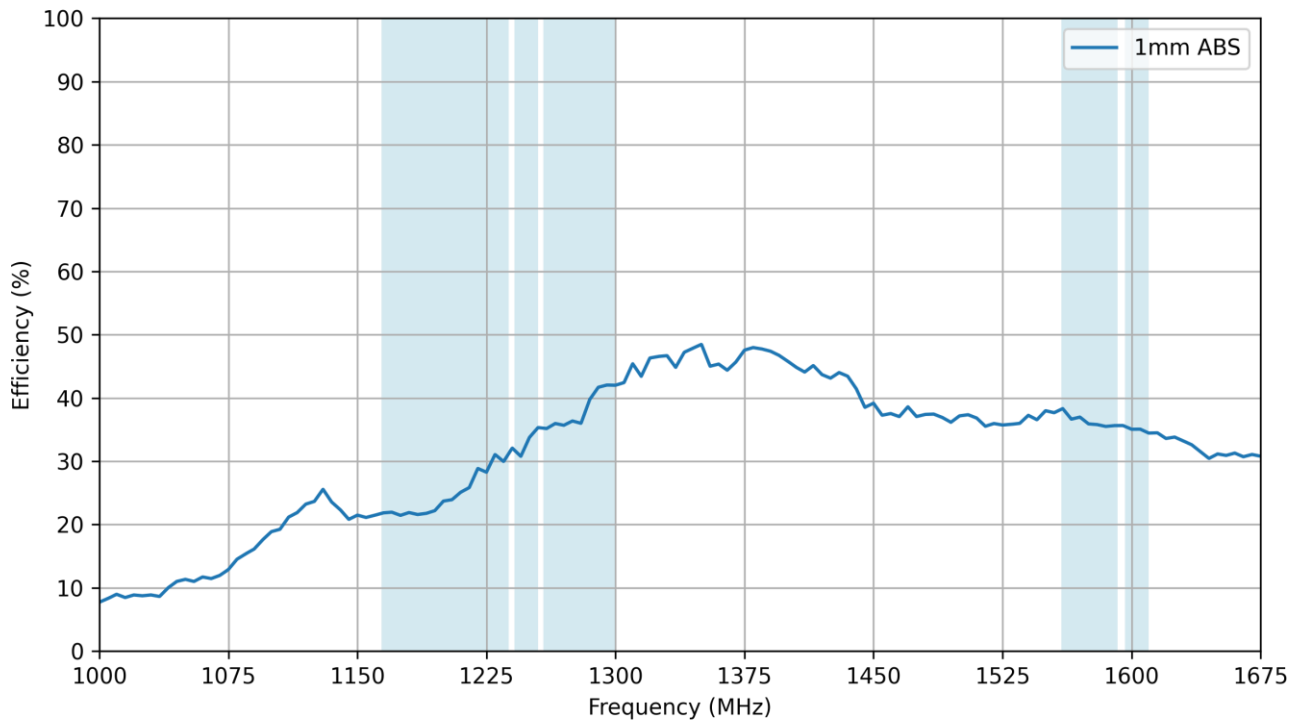

## 5.5 Average Gain

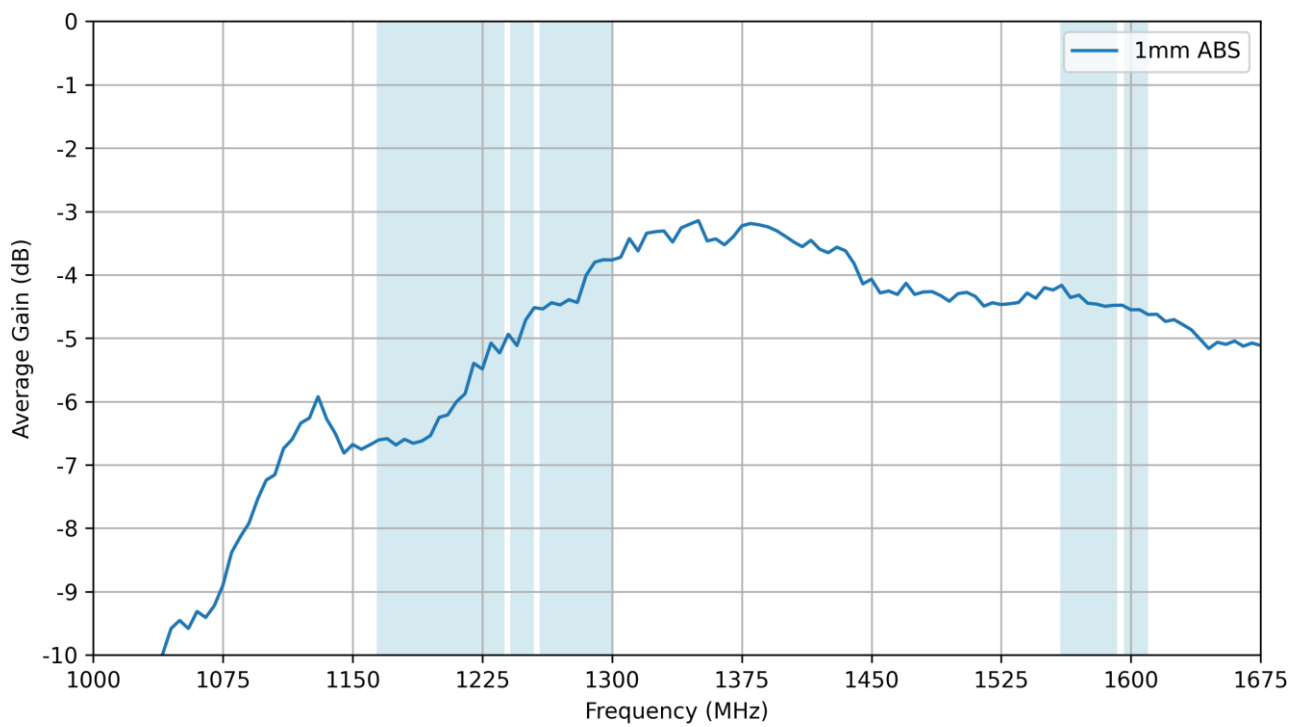

5.6 Peak Gain (Gtotal)

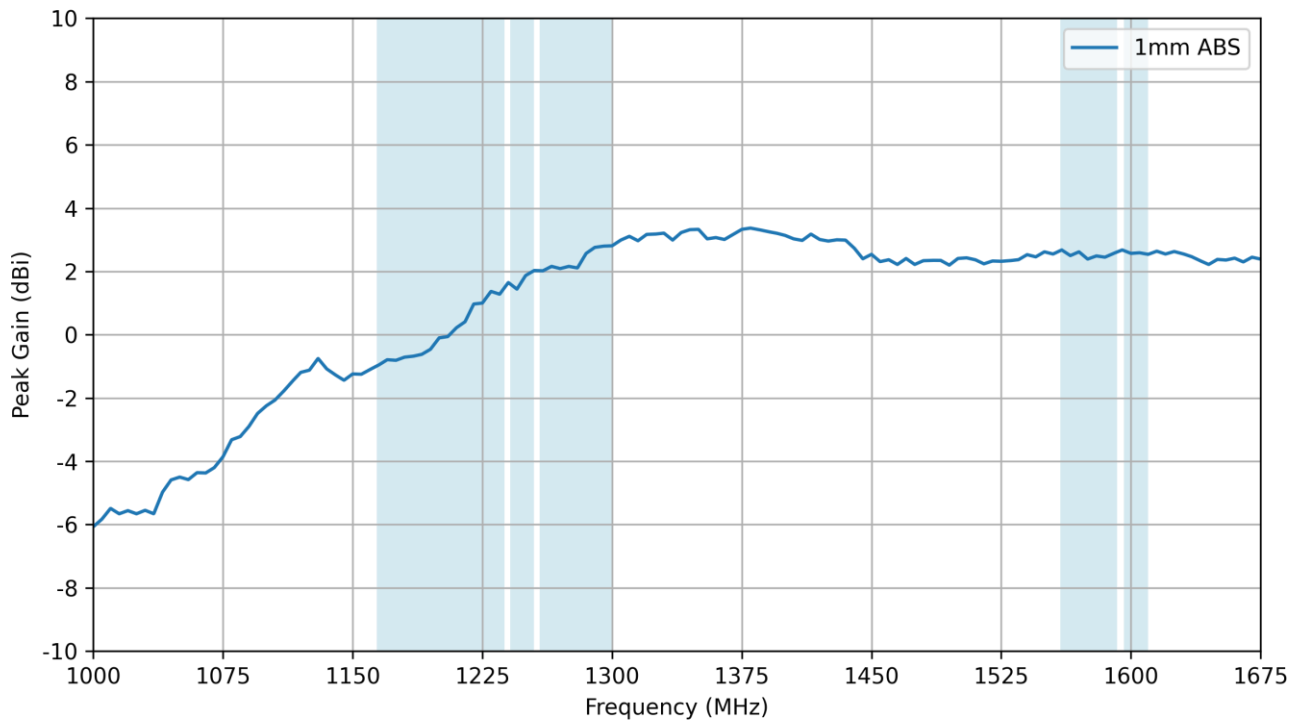

## 6. Radiation Patterns

### 6.1 Test Setup

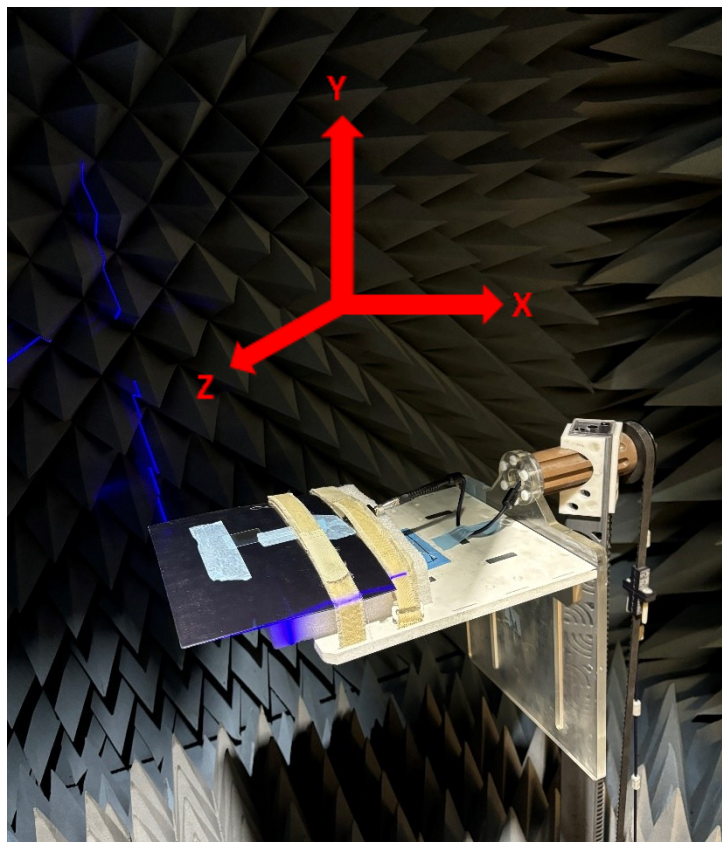
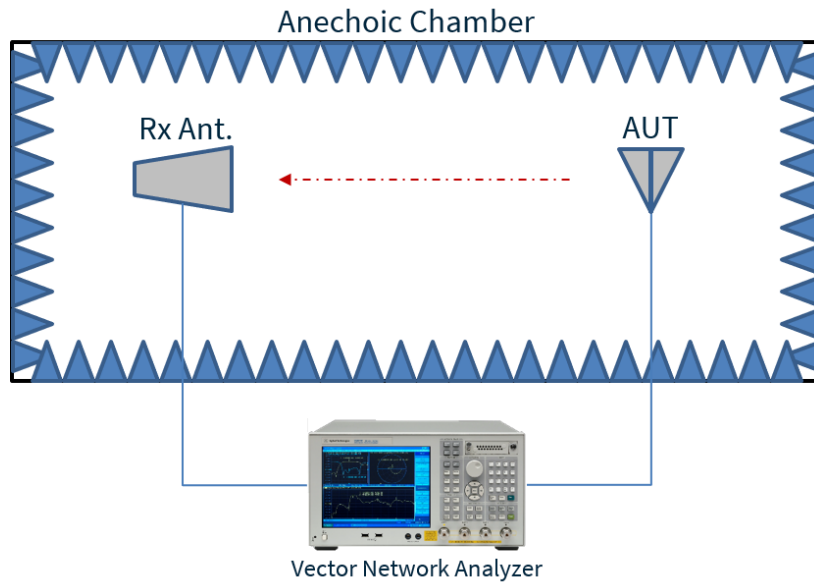

Chamber Test Set-up

6.2 1mm ABS Patterns at 1175 MHz

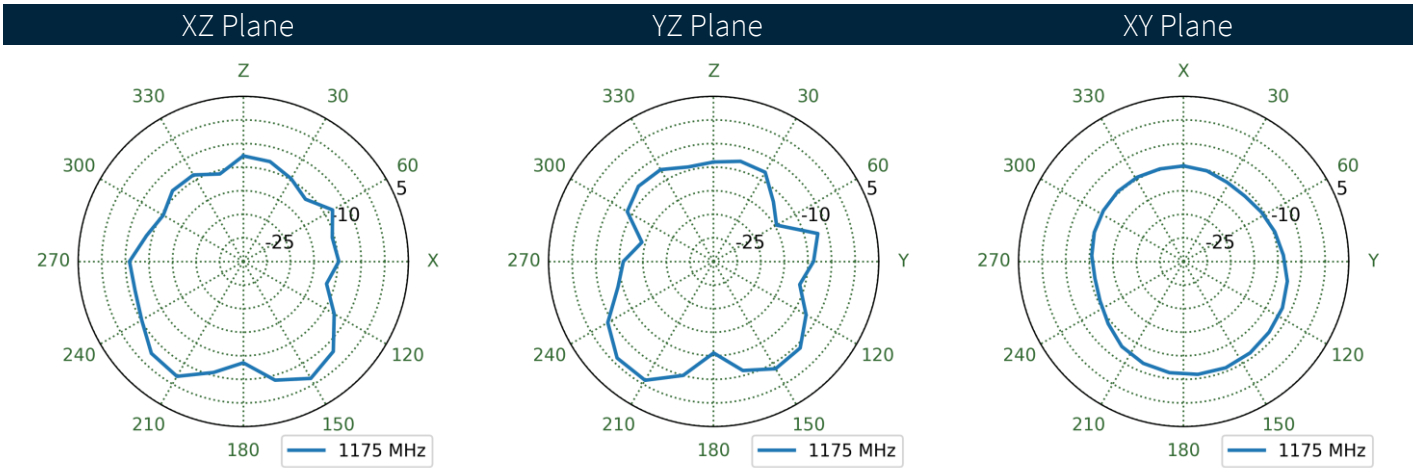
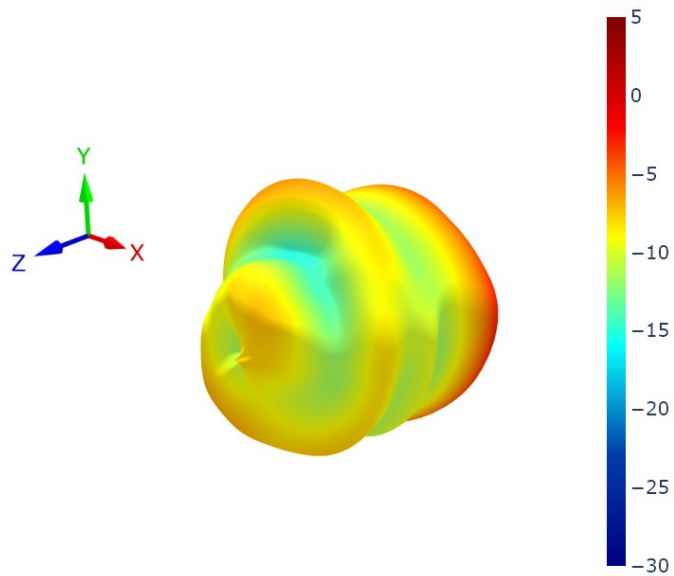

6.3 1mm ABS Patterns at 1225 MHz

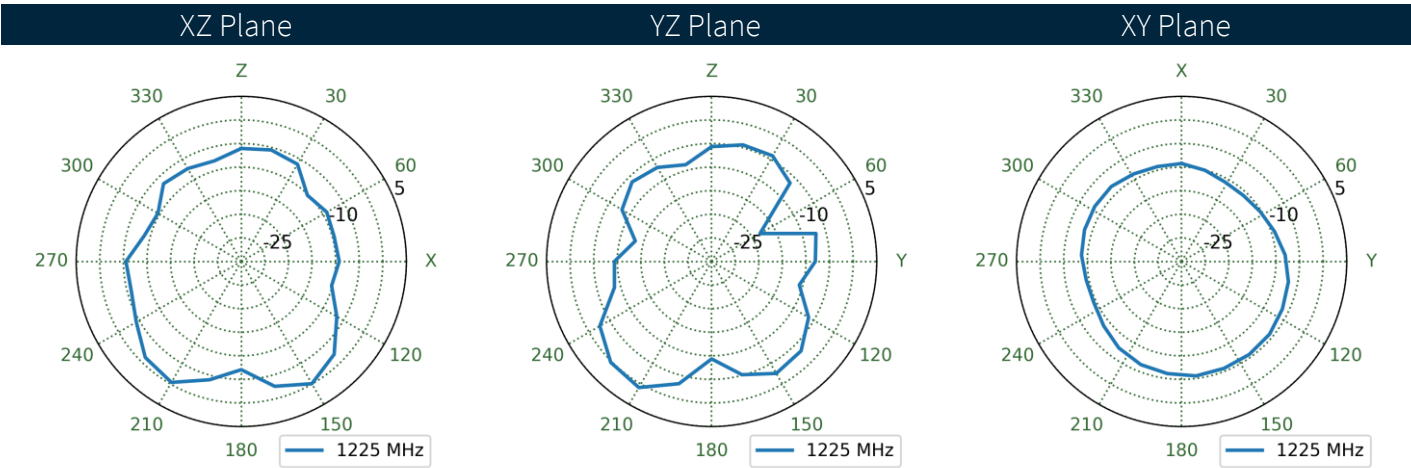
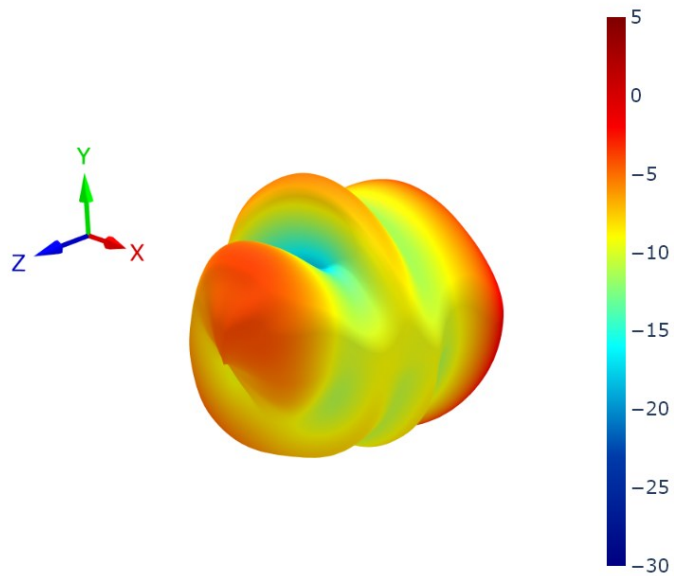

6.4 1mm ABS Patterns at 1560 MHz

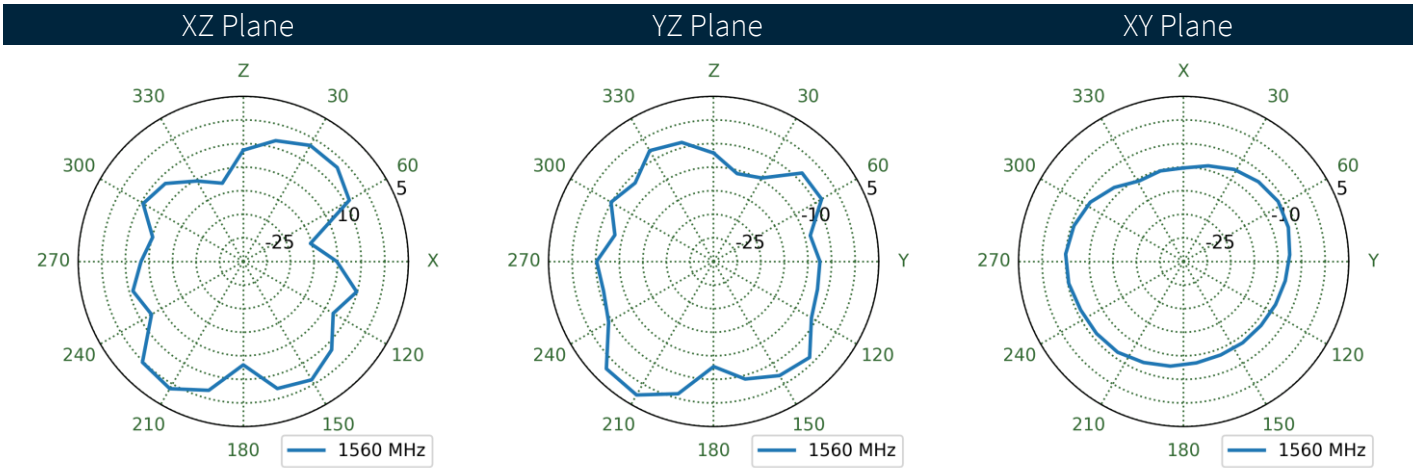
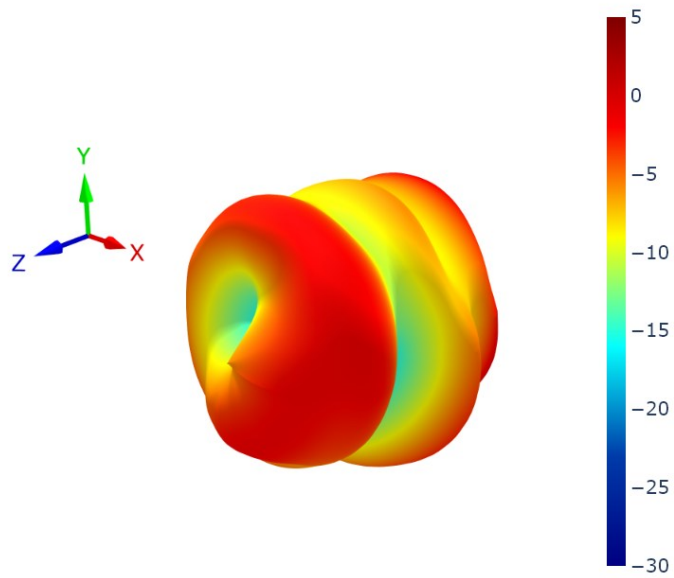

6.5 1mm ABS Patterns at 1575 MHz

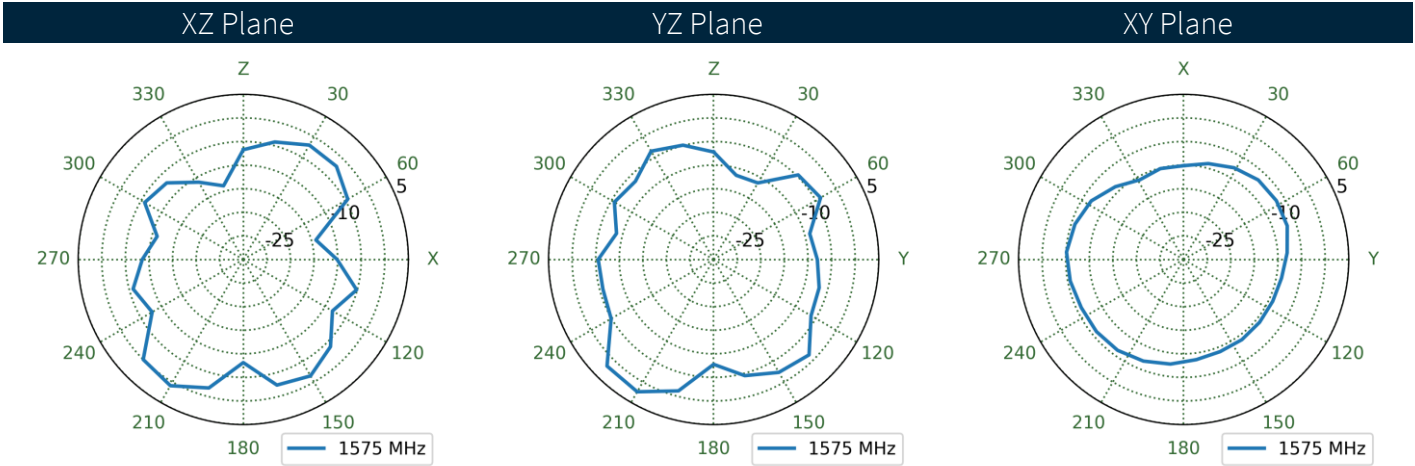
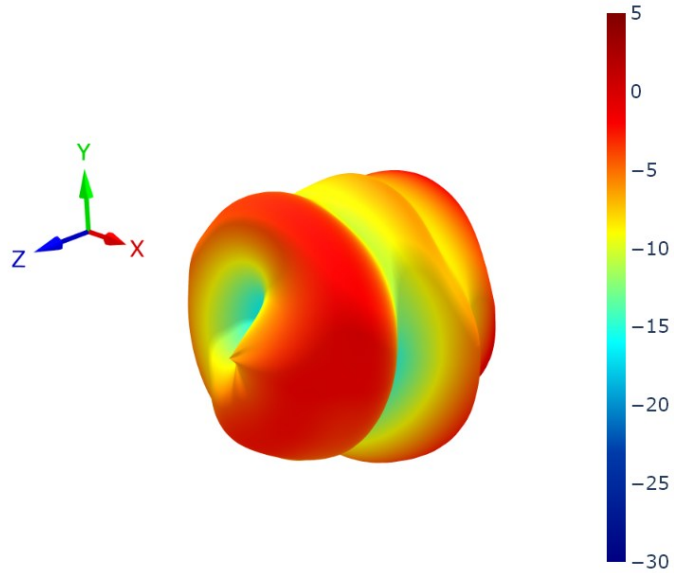



6.6 1mm ABS Patterns at 1605 MHz

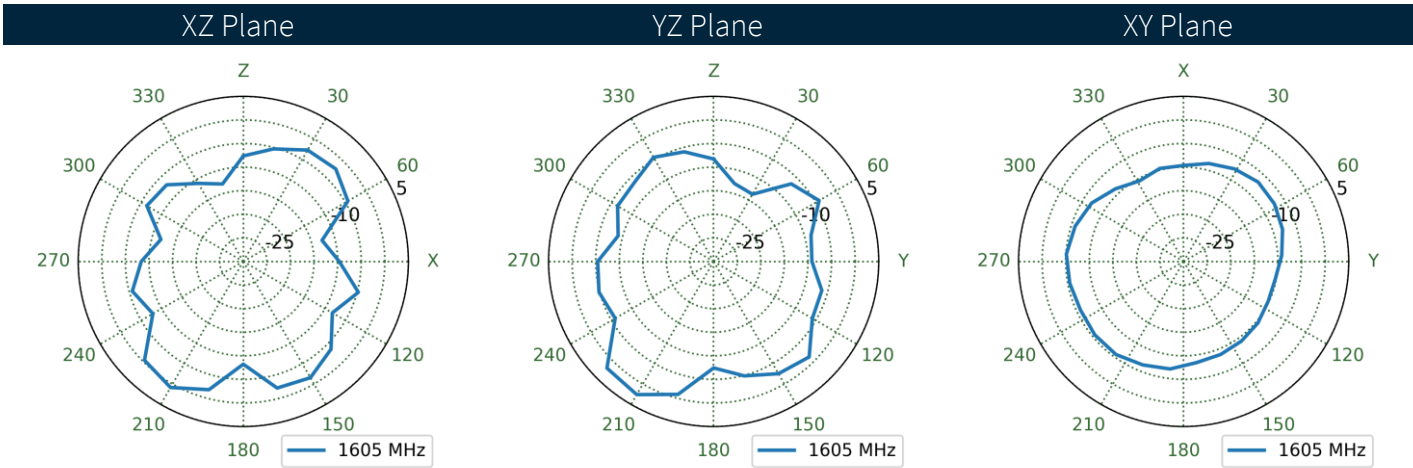
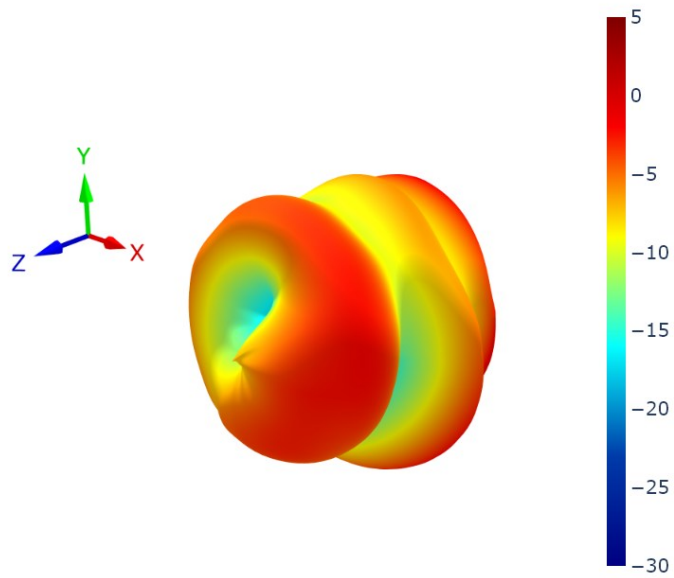

Changelog for the datasheet

SPE-24-8-214 – TFX125.B

Revision: A (Original First Release)	
Date:	2024-09-06
Notes:	Initial Release
Author:	Gary West

Previous Revisions



[www.taoglas.com](http://www.taoglas.com)

